

---titleSpecial Assignment Operators ++ and --

# C Programming Tutorial

---

4th Edition (K&R version)

Mark Burgess  
Faculty of Engineering, Oslo College

---

Copyright © 1987,1999 Mark Burgess

Permission is granted to make and distribute verbatim copies of this manual provided the copyright notice and this permission notice are preserved on all copies.

## Preface

Every program is limited by the language which is used to write it. C is a programmer's language. Unlike BASIC or Pascal, C was not written as a teaching aid, but as an implementation language. C is a computer language and a programming tool which has grown popular because programmers like it! It is a tricky language but a masterful one. Sceptics have said that it is a language in which everything which can go wrong does go wrong. True, it does not do much hand holding, but also it does not hold anything back. If you have come to C in the hope of finding a powerful language for writing everyday computer programs, then you will not be disappointed. C is ideally suited to modern computers and modern programming.

This book is a tutorial. Its aim is to teach C to a beginner, but with enough of the details so as not be outgrown as the years go by. It presumes that you have some previous acquaintance with programming — you need to know what a variable is and what a function is — but you do not need much experience. It is not essential to follow the order of the chapters rigorously, but if you are a beginner to C it is recommended. When it comes down to it, most languages have basically the same kinds of features: variables, ways of making loops, ways of making decisions, ways of accessing files etc. If you want to plan your assault on C, think about what you already know about programming and what you expect to look for in C. You will most likely find all of those things and more, as you work through the chapters.

The examples programs range from quick one-function programs, which do no more than illustrate the sole use of one simple feature, to complete application examples occupying several pages. In places these examples make use of features before they have properly been explained. These programs serve as a taster of what is to come.

**Mark Burgess. 1987, 1999**

*This book was first written in 1987; this new edition was updated and rewritten in 1999. The book was originally published by Dabs Press. Since the book has gone out of print, David Atherton of Dabs and I agreed to release the manuscript, as per the original contract. This new edition is written in Texinfo, which is a documentation system that uses a single source file to produce both on-line information and printed output. You can read this tutorial online, using either the Emacs Info reader, the standalone Info reader, or a World Wide Web browser, or you can read this same text as a typeset, printed book.*



# 1 Introduction

*What is C? What is it for? Why is it special?*

## 1.1 High Levels and Low Levels

Any kind of object that is sufficiently complicated can be thought of as having levels of detail; the amount of detail we see depends upon how closely we scrutinize it. A computer falls definitely into the category of complex objects and it can be thought of as working at many different levels. The terms *low level* and *high level* are often used to describe these onion-layers of complexity in computers. Low level is perhaps the easiest to understand: it describes a level of detail which is buried down amongst the working parts of the machine: the low level is the level at which the computer seems most primitive and machine-like. A higher level describes the same object, but with the detail left out. Imagine stepping back from the complexity of the machine level pieces and grouping together parts which work together, then covering up all the details. (For instance, in a car, a group of nuts, bolts, pistons can be grouped together to make up a new basic object: an engine.) At a high level a computer becomes a group of black boxes which can then be thought of as the basic components of the computer.

C is called a high level, compiler language. The aim of any high level computer language is to provide an easy and natural way of giving a programme of instructions to a computer (a computer program). The language of the raw computer is a stream of numbers called machine code. As you might expect, the action which results from a single machine code instruction is very primitive and many thousands of them are required to make a program which does anything substantial. It is therefore the job of a high level language to provide a new set of black box instructions, which can be given to the computer without us needing to see what happens inside them – and it is the job of a compiler to fill in the details of these "black boxes"

so that the final product is a sequence of instructions in the language of the computer.

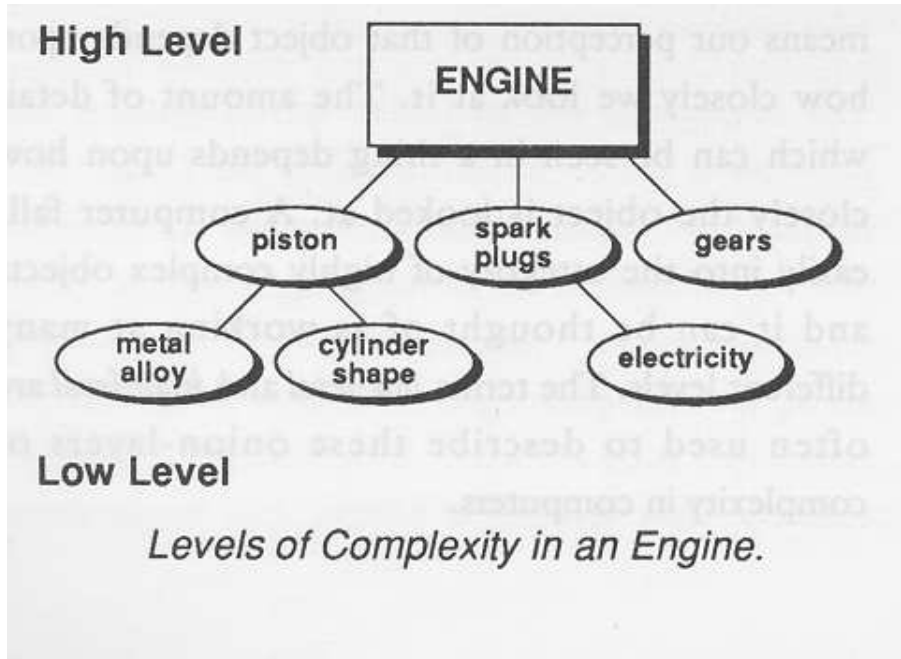

C is one of a large number of high level languages which can be used for general purpose programming, that is, anything from writing small programs for personal amusement to writing complex applications. It is unusual in several ways. Before C, high level languages were criticized by machine code programmers because they shielded the user from the working details of the computer, with their black box approach, to such an extent that the languages become inflexible: in other words, they did not allow programmers to use all the facilities which the machine has to offer. C, on the other hand, was designed to give access to any level of the machine down

to raw machine code and because of this it is perhaps the most flexible of all high level languages.

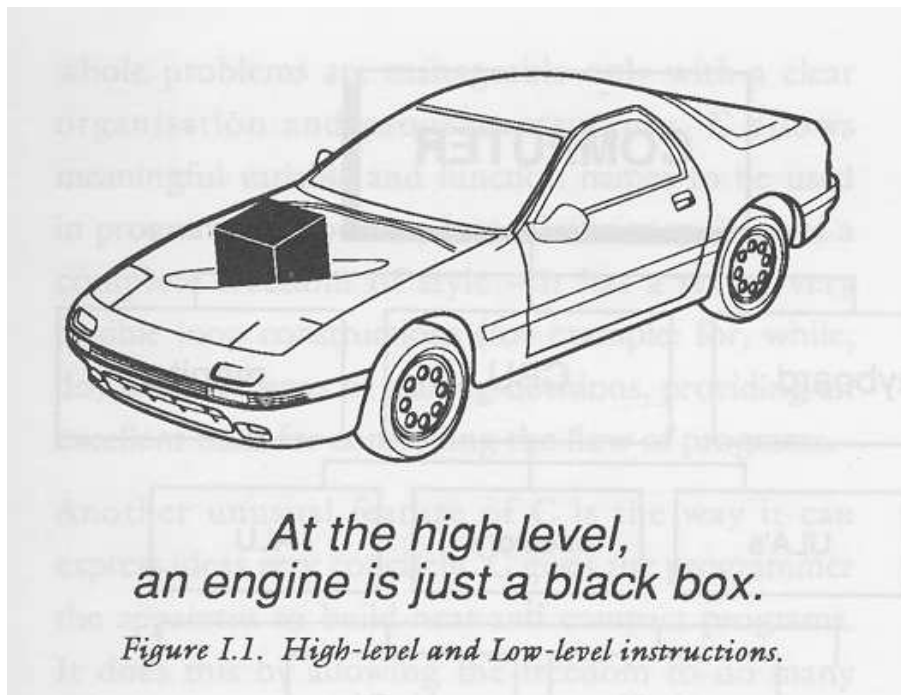

Surprisingly, programming books often ignore an important role of high level languages: high level programs are not only a way to express instructions to the computer, they are also a means of communication among human beings. They are not merely monologues to the machine, they are a way to express ideas and a way to solve problems. The C language has been equipped with features that allow programs to be organized in an easy and logical way. This is vitally important for writing lengthy programs because complex problems are only manageable with a clear organization and program structure. C allows meaningful variable names and meaningful function names to be used in programs without any loss of efficiency and it gives a complete freedom of style; it has a set of very flexible loop construc-

tions (`for`, `while`, `do`) and neat ways of making decisions. These provide an excellent basis for controlling the flow of programs.

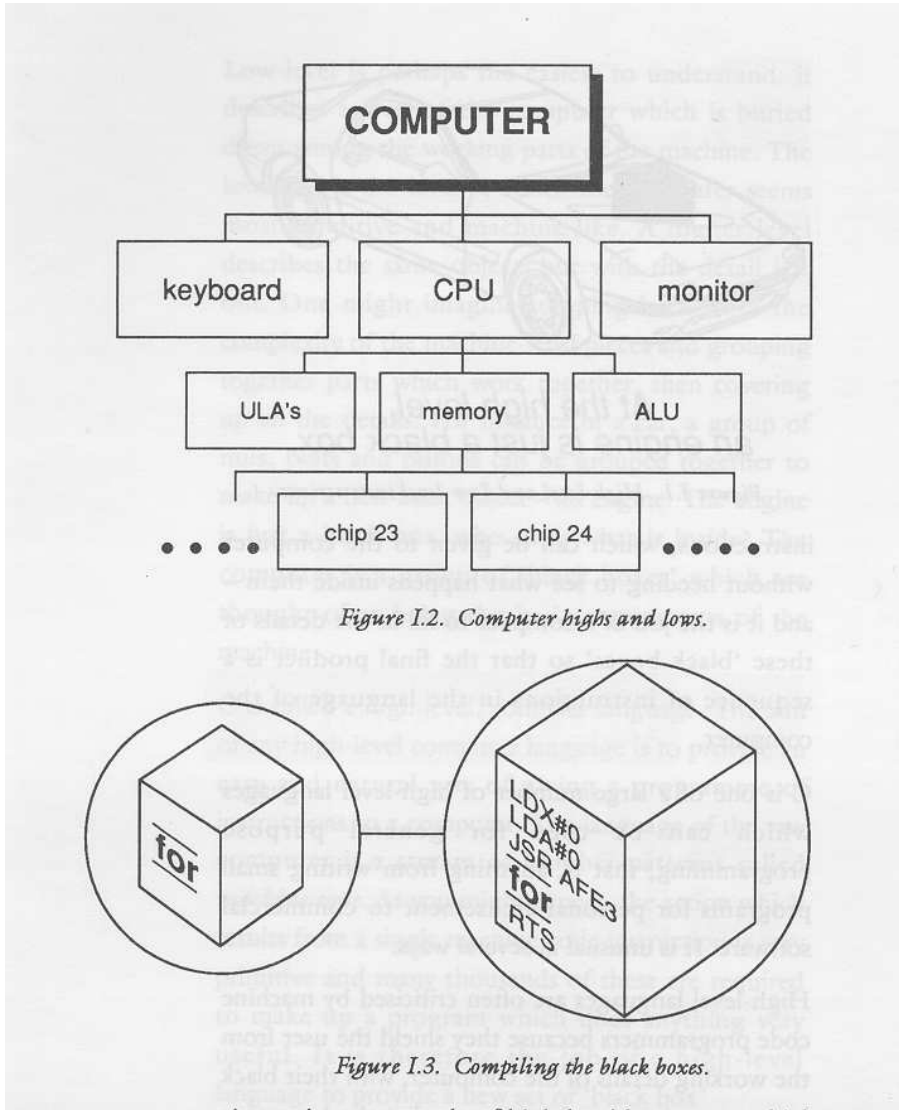

Another unusual feature of C is the way it can express ideas concisely. The richness of a language shapes what it can talk about. C gives us the apparatus to build neat and compact programs. This sounds, first of all, either like a great bonus or something a bit suspect. Its conciseness can be a mixed blessing: the aim is to try to seek a balance between the often conflicting interests of readability of programs and their conciseness. Because



this side of programming is so often presumed to be understood, we shall try to develop a style which finds the right balance.

C allows things which are disallowed in other languages: this is no defect, but a very powerful freedom which, when used with caution, opens up possibilities enormously. It does mean however that there are aspects of C which can run away with themselves unless some care is taken. The programmer carries an extra responsibility to write a careful and thoughtful program. The reward for this care is that fast, efficient programs can be produced.

C tries to make the best of a computer by linking as closely as possible to the local environment. It is no longer necessary to have to put up with hopelessly inadequate input/output facilities anymore (a legacy of the timesharing/mainframe computer era): one can use everything that a computer has to offer. Above all it is flexible. Clearly no language can guarantee intrinsically good programs: there is always a responsibility on the programmer, personally, to ensure that a program is neat, logical and well organized, but it can give a framework in which it is easy to do so.

The aim of this book is to convey some of the C philosophy in a practical way and to provide a comprehensive introduction to the language by appealing to a number of examples and by sticking to a strict structuring scheme. It is hoped that this will give a flavour of the kind of programming which C encourages.

## 1.2 Basic ideas about C

*What to do with a compiler. What can go wrong.*

Using a compiler language is not the same as using an interpreted language like BASIC or a GNU shell. It differs in a number of ways. To begin with, a C program has to be created in two stages:

- Firstly, the program is written in the form of a number of text files using a screen editor. This form of the program is called the *source program*. It is not possible to execute this file directly.
- Secondly, the completed source file is passed to a compiler—a program which generates a new file containing a machine code translation of the source text. This file is called an object file or executable file. The executable file is said to have been compiled from the source text.

Compiler languages do not usually contain their own editor, nor do they have words like 'RUN' with which to execute a finished program. You use a screen editor to create the words of a program (program text) and run the final program in its compiled form usually by simply typing the name of the executable file.

### 1.3 The Compiler

A C program is made by running a *compiler* which takes the typed source program and converts it into an object file that the computer can execute. A compiler usually operates in two or more phases (and each phase may have stages within it). These phases must be executed one after the other. As we

shall see later, this approach provides a flexible way of compiling programs which are split into many files.

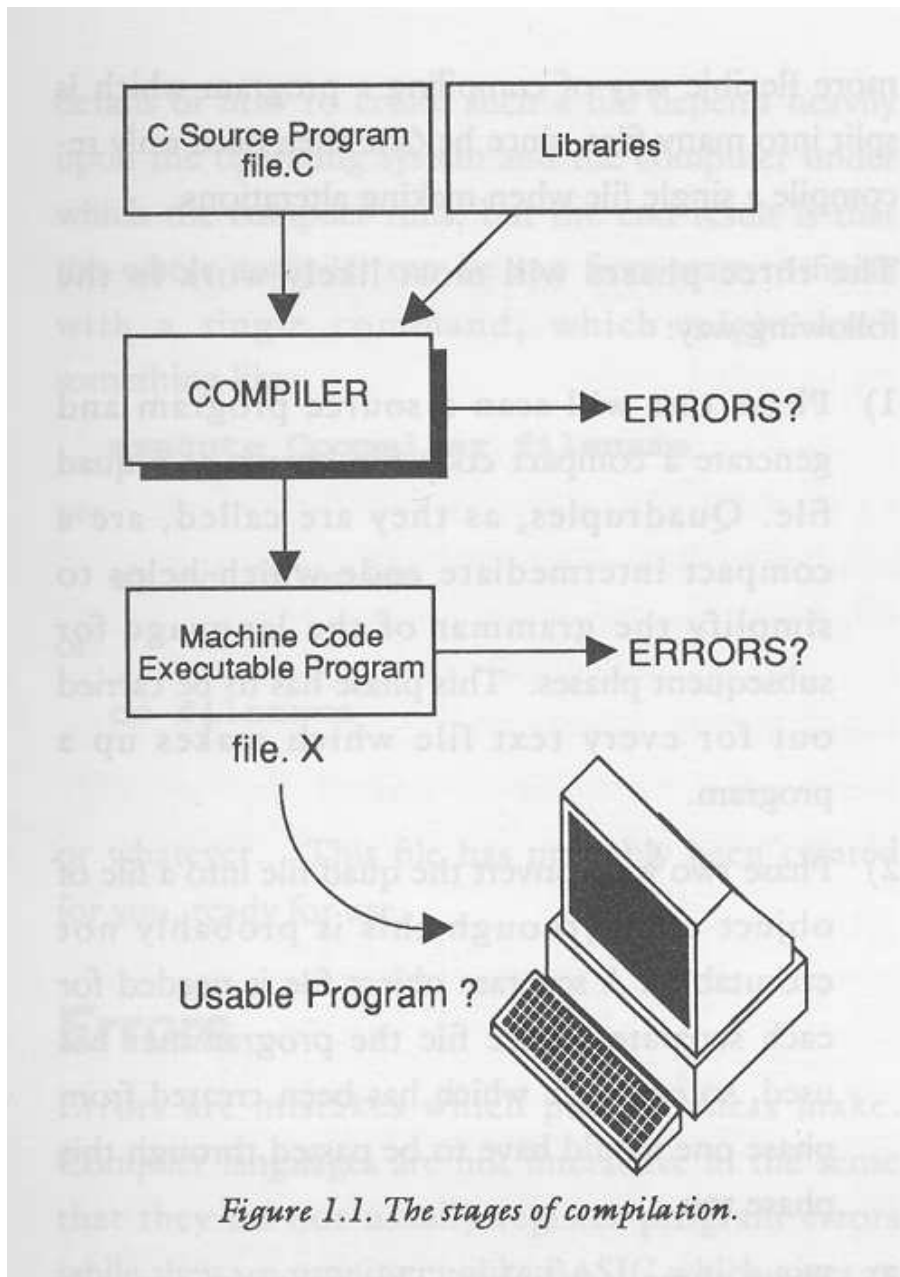

A two-phase compiler works in the following way:

- Phase 1 scans a source program, perhaps generating an intermediate code (quadruples or pcode) which helps to simplify the grammar of the language for subsequent processing. It then converts the intermediate code into a file of object code (though this is usually not executable yet). A separate object file is built for each separate source file. In the GNU C compiler, these two stages are run with the command `gcc -c`; the output is one or more `.o` files.
- Phase 2 is a Linker. This program appends standard library code to the object file so that the code is complete and can "stand alone". A C compiler linker suffers the slightly arduous task of linking together all the functions in the C program. Even at this stage, the compiler can fail, if it finds that it has a reference to a function which does not exist. With the GNU C compiler this stage is activated by the command `gcc -o` or `ld`.

To avoid the irritation of typing two or three separate commands (which are often cumbersome) you will normally find a simple interface for executing compiler. Traditionally this is an executable program called `cc` for C Compiler:

```
cc filename
```

```
gcc filename
```

On GNU systems, this results in the creation of an executable program with the default name `a.out`. To tell the compiler what you would like the executable program to be called, use the `-o` option for setting the name of the object code:

```
gcc -o program-name filename
```

For example, to create a program called 'myprog' from a file called `myprog.c`, write

```
gcc -o myprog myprog.c
```

## 1.4 Errors

Errors are mistakes which we the programmers make. There are different kinds of error:

### *Syntax*

Errors in the syntax, or word structure of a program are caught before you run it, at compilation time by the compiler program. They are listed all in one go, with the line number, in the text file, at which the error occurred and a message to say what was wrong.

For example, suppose you write `sin (x) y = ;` in a program instead of `y = sin (x) ;`, which assigns the value of the sin of 'x' to 'y'. Upon compilation, you would see this error message:

```
eg.c: In function 'main':  
eg.c:12: parse error before 'y'
```

(If you compile the program in Emacs, you can jump directly to the error.)

A program with syntax errors will cause a compiler program to stop trying to generate machine code and will not create an executable. However, a compiler will usually not stop at the first error it encounters but will attempt to continue checking the syntax of a program right to the last line before aborting, and it is common to submit a program for compilation only to receive a long and ungratifying list of errors from the compiler.

It is a shock to everyone using a compiler for the first time how a single error can throw the compiler off course and result in a huge and confusing list of non-existent errors, following a single true culprit. The situation thus looks much worse than it really is. You'll get used to this with experience, but it can be very disheartening.

As a rule, look for the *first* error, fix that, and then recompile. Of course, after you have become experienced, you will recognize when subsequent error messages are due to independent problems and when they are due to a cascade. But at the beginning, just look for and fix the first error.

### *Intention*

Errors in goal or purpose (logical errors) occur when you write a program that works, but does not do what you intend it to do. You intend to send a letter to all drivers whose licenses will expire soon; instead, you send a letter to all drivers whose licenses will expire sometime.

If the compilation of a program is successful, then a new file is created. This file will contain machine code which can be executed according to the rules of the computer's local operating system.

When a programmer wants to make alterations and corrections to a C program, these have to be made in the source text file itself using an editor; the program, or the salient parts, must then be recompiled.

## 1.5 Use of Upper and Lower Case

One of the reasons why the compiler can fail to produce the executable file for a program is you have mistyped something, even through the careless use of upper and lower case characters. The C language is *case dependent*. Unlike languages such as Pascal and some versions of BASIC, the C compiler distinguishes between small letters and capital letters. This is a potential source of quite trivial errors which can be difficult to spot. If a letter is

typed in the wrong case, the compiler will complain and it will not produce an executable program.

## 1.6 Declarations

Compiler languages require us to make a list of the names and types of all variables which are going to be used in a program and provide information about where they are going to be used. This is called *declaring* variables. It serves two purposes: firstly, it provides the compiler with a definitive list of the variables, enabling it to cross check for errors, and secondly, it informs the compiler how much space must be reserved for each variable when the program is run. C supports a variety of variable types (variables which hold different kinds of data) and allows one type to be converted into another. Consequently, the type of a variable is of great importance to the compiler. If you fail to declare a variable, or declare it to be the wrong type, you will see a compilation error.

## 1.7 Questions

1. What is a compiler?
2. How is a C program run?
3. How is a C program compiled usually?
4. Are upper and lower case equivalent in C?
5. What the two different kinds of error which can be in a program?

## 2 Reserved words and an example

C programs are constructed from a set of reserved words which provide control and from libraries which perform special functions. The basic instructions are built up using a reserved set of words, such as `main`, `for`, `if`, `while`, `default`, `double`, `extern`, `for`, and `int`, to name just a few. These words may not be used in just any old way: C demands that they are used only for giving commands or making statements. You cannot use `default`, for example, as the name of a variable. An attempt to do so will result in a compilation error.

See [\(undefined\)](#) [All the Reserved Words], page [\(undefined\)](#), for a complete list of the reserved words.

Words used in included libraries are also, effectively, reserved. If you use a word which has already been adopted in a library, there will be a conflict between your choice and the library.

Libraries provide *frequently used functionality* and, in practice, at least one library must be included in every program: the so-called C library, of standard functions. For example, the `stdio` library, which is part of the C library, provides standard facilities for input to and output from a program.

In fact, most of the facilities which C offers are provided as libraries that are included in programs as plug-in expansion units. While the features provided by libraries are not strictly a part of the C language itself, they are essential and you will never find a version of C without them. After a library has been included in a program, its functions are defined and you cannot use their names.

### 2.1 The `printf()` function

One invaluable function provided by the standard input/output library is called `printf` or ‘print-formatted’. It provides an superbly versatile way of printing text. The simplest way to use it is to print out a literal string:

```
printf ("..some string..");
```

Text is easy, but we also want to be able to print out the contents of variables. These can be inserted into a text string by using a ‘control sequence’ inside the quotes and listing the variables after the string which get inserted into the string in place of the *control sequence*. To print out an integer, the control sequence `%d` is used:

```
printf ("Integer = %d",someinteger);
```

The variable `someinteger` is printed instead of `%d`. The `printf` function is described in full detail in the relevant chapter, but we’ll need it in many places before that. The example program below is a complete program. If you are reading this in Info, you can copy this to a file, compile and execute it.

## 2.2 Example Listing

```

/*****
/* Short Poem */
/*****

#include <stdio.h>

/*****

main ()          /* Poem */

{
printf ("Astronomy is %d derful \n",1);
printf ("And interesting %d \n",2);
printf ("The ear%d volves around the sun \n",3);
printf ("And makes a year %d you \n",4);
printf ("The moon affects the sur %d heard \n",5);
printf ("By law of phy%d great \n",6);
printf ("It %d when the the stars so bright \n",7);
printf ("Do nightly scintill%d \n",8);
printf ("If watchful providence be%d \n",9);
printf ("With good intentions fraught \n");
printf ("Should not keep up her watch divine \n");
printf ("We soon should come to %d \n",0);
}

```

## 2.3 Output

```

Astronomy is 1 derful \n
And interesting 2
The ear3 volves around the sun
And makes a year 4 you
The moon affects the sur 5 heard
By law of phy6d great
It 7 when the the stars so bright
Do nightly scintill8
If watchful providence be9
With good intentions fraught
Should not keep up her watch divine
We soon should come to 0

```

## 2.4 Questions

1. Write a command to print out the message "Wow big deal".
2. Write a command to print out the number 22?
3. Write two commands to print out "The 3 Wise Men" two different ways.
4. Why are there only a few reserved command words in C?



## 3 Operating systems and environments

*Where is a C program born? How is it created?*

The basic control of a computer rests with its operating system. This is a layer of software which drives the hardware and provides users with a comfortable environment in which to work. An operating system has two main components which are of interest to users: a *user interface* (often a command language) and a *filing system*. The operating system is the route to all input and output, whether it be to a screen or to files on a disk. A programming language has to get at this input and output easily so that programs can send out and receive messages from the user and it has to be in contact with the operating system in order to do this. In C the link between these two is very efficient.

Operating systems vary widely but most have a command language or *shell* which can be used to type in commands. Recently the tendency has been to try to eliminate typing completely by providing graphical user interfaces (GUIs) for every purpose. GUIs are good for carrying out simple procedures like editing, but they are not well suited to giving complicated instructions to a computer. For that one needs a command language. In the network version of this book we shall concentrate on Unix shell commands since they are the most important to programmers. On microcomputers command languages are usually very similar in concept, though more primitive, with only slightly different words for essentially the same commands. (This is a slightly superficial view).

When most compiler languages were developed, they were intended to be run on large mainframe computers which operated on a multi-user, time-sharing principle and were incapable of interactive communication with the user. Many compiler languages still have this inadequacy when carried over to modern computers, but C is an exception, because of its unique design. Input and output are not actually defined as a fixed, unchanging part of the C language. Instead there is a standard file which has to be included in programs and defines the input/output commands that are supported by the language for a particular computer and operating system. This file is called a standard C library. (See the next chapter for more information.) The library is standard in the sense that C has developed a set of functions which all computers and operating systems must implement, but which are specially adapted to your system.

### 3.1 Files and Devices

The filing system is also a part of input/output. In many operating systems all routes in and out of the computer are treated by the operating system as though they were files or data *streams* (even the keyboard!). C does this implicitly (it comes from Unix). The file from which C normally gets its

input from is called *stdin* or standard input file and it is usually the keyboard. The corresponding route for output is called "stdout" or standard output file and is usually a monitor screen. Both of these are parts of *stdio* or *standard input output*. The keyboard and the monitor screen are not really files, of course, they are 'devices', (it is not possible to re-read what has been sent to the monitor", or write to the keyboard.), but devices are represented by files with special names, so that the keyboard is treated as a read-only file, the monitor as a write only file... The advantage of treating devices like this is that it is not necessary to know how a particular device works, only that it exists somewhere, connected to the computer, and can be written to or read from. In other words, it is exactly the same to read or write from a device as it is to read or write from a file. This is a great simplification of input/output! The filenames of devices (often given the lofty title 'pseudo device names') depend upon your particular operating system. For instance, the printer might be called "PRN" or "PRT". You might have to open it explicitly as a file. When input is taken solely from the keyboard and output is always to the screen then these details can just be forgotten.

## 3.2 Filenames

The compiler uses a special convention for the file names, so that we do not confuse their contents. The name of a source program (the code which you write) is '*filename.c*'. The compiler generates a file of object code from this called '*filename.o*', as yet unlinked. The final program, when linked to libraries is called '*filename*' on Unix-like operating systems, and '*filename.EXE*' on Windows derived systems. The libraries themselves are also files of object code, typically called '*liblibraryname.a*' or '*liblibraryname.so*'. Header files are always called '*libname.h*'.

The endings 'dot something' (called file extensions) identify the contents of files for the compiler. The dotted endings mean that the compiler can generate an executable file with the same name as the original source – just a different ending. The quad file and the object file are only working files and should be deleted by the compiler at the end of compilation. The '.c' suffix is to tell the compiler that the file contains a C source program and similarly the other letters indicate non-source files in a convenient way. To execute the compiler you type,

```
cc filename
```

For example,

```
cc foo.c
```

## 3.3 Command Languages and Consoles

In order to do anything with a compiler or an editor you need to know a little about the command language of the operating system. This means the instructions which can be given to the system itself rather than the words which make up a C program. e.g.

```
ls -l
```

```
less filename
```

```
emacs filename
```

In a large operating system (or even a relatively small one) it can be a major feat of recollection to know all of the commands. Fortunately it is possible to get by with knowing just handful of the most common ones and having the system manual around to leaf through when necessary.

Another important object is the ‘panic button’ or program interruption key. Every system will have its own way of halting or terminating the operation of a program or the execution of a command. Commonly this will involve two simultaneous key presses, such as *CTRL C*, *CTRL Z* or *CTRL-D* etc. In GNU/Linux, *CTRL-C* is used.

### 3.4 Questions

1. What is an operating system for?
2. What is a pseudo-device name?
3. If you had a C source program which you wanted to call ‘accounts’ what name would you save it under?
4. What would be the name of the file produced by the compiler of the program in 3?
5. How would this program be run?



## 4 Libraries

*Plug-in C expansions. Header files.*

The core of the C language is small and simple. Special functionality is provided in the form of libraries of ready-made functions. This is what makes C so portable. Some libraries are provided for you, giving you access to many special abilities without needing to reinvent the wheel. You can also make your own, but to do so you need to know how your operating system builds libraries. We shall return to this later.

Libraries are files of ready-compiled code which we can merge with a C program at compilation time. Each library comes with a number of associated *header files* which make the functions easier to use. For example, there are libraries of mathematical functions, string handling functions and input/output functions and graphics libraries. It is up to every programmer to make sure that libraries are added at compilation time by typing an optional string to the compiler. For example, to merge with the math library 'libm.a' you would type

```
cc -o program_name prog.c -lm
```

when you compile the program. The '-lm' means: add in 'libm'. If we wanted to add in the socket library 'libsocket.a' to do some network programming as well, we would type

```
cc -o program_name prog.c -lm -lsocket
```

and so on.

Why are these libraries not just included automatically? Because it would be a waste for the compiler to add on lots of code for maths functions, say, if they weren't needed. When library functions are used in programs, the appropriate library code is included by the compiler, making the resulting object code often much longer.

Libraries are supplemented by header files which define *macros*, *data types* and *external data* to be used in conjunction with the libraries. Once a header file has been included, it has effectively added to the list of reserved words and commands in the language. You cannot then use the names of functions or macros which have already been defined in libraries or header files to mean anything other than what the library specifies.

The most commonly used header file is the standard input/output library which is called 'stdio.h'. This belongs to a subset of the standard C library which deals with file handling. The 'math.h' header file belongs to the mathematics library 'libm.a'. Header files for libraries are included by adding to the source code:

```
#include header.h
```

at the top of a program file. For instance:

```
#include "myheader.h"
```

includes a personal header file which is in the current directory. Or

```
#include <stdio.h>
```

includes a file which lies in a standard directory like `‘/usr/include’`.

The `#include` directive is actually a command to the C preprocessor, which is dealt with more fully later, See Chapter 12 [Preprocessor], page 71.

Some functions can be used without having to include library files or special libraries explicitly since every program is always merged with the standard *C library*, which is called `‘libc’`.

```
#include <stdio.h>

main ()

{
printf ("C standard I/O file is included\n");
printf ("Hello world!");
}
```

A program wishing to use a mathematical function such as `cos` would need to include a mathematics library header file.

```
#include <stdio.h>
#include <math.h>

main ()

{ double x,y;

y = sin (x);
printf ("Maths library ready");
}
```

A particular operating system might require its own special library for certain operations such as using a mouse or for opening windows in a GUI environment, for example. These details will be found in the local manual for a particular C compiler or operating system.

Although there is no limit, in principle, to the number of libraries which can be included in a program, there may be a practical limit: namely memory, since every library adds to the size of both source and object code.

Libraries also add to the time it takes to compile a program. Some operating systems are smarter than others when running programs and can load in only what they need of the large libraries. Others have to load in everything before they can run a program at all, so many libraries would slow them down.

To know what names libraries have in a particular operating system you have to search through its documentation. Unix users are lucky in having an online manual which is better than most written ones.

## 4.1 Questions

1. How is a library file incorporated into a C program?
2. Name the most common library file in C.
3. Is it possible to define new functions with the same names as standard library functions?
4. What is another name for a library file?





## 5 Programming style

*The shape of programs to come.*

C is actually a free format language. This means that there are no rules about how it must be typed, when to start new lines, where to place brackets or whatever. This has both advantages and dangers. The advantage is that the user is free to choose a style which best suits him or her and there is freedom in the way in which a program can be structured. The disadvantage is that, unless a strict style is adopted, very sloppy programs can be the result. The reasons for choosing a well structured style are that:

- Long programs are *manageable* only if programs are properly organized.
- Programs are only *understandable* if care is taken in choosing the names of variables and functions.
- It is much easier to find parts of a program if a strict ordering convention is maintained. Such a scheme becomes increasingly difficult to achieve with the size and complexity of the problem.

No simple set of rules can ever provide the ultimate solution to writing good programs. In the end, experience and good judgement are the factors which decide whether a program is written well or poorly written. The main goal of any style is to achieve *clarity*. Previously restrictions of memory size, power and of particular compilers often forced restrictions upon style, making programs clustered and difficult. All computers today are equipped with more than enough memory for their purposes, and have very good optimizers which can produce faster code than most programmers could write themselves without help, so there are few good reasons not to make programs as clear as possible.



## 6 The form of a C program

*What goes into a C program? What will it look like?*

C is made up entirely of building blocks which have a particular 'shape' or form. The form is the same everywhere in a program, whether it is the form of the main program or of a subroutine. A program is made up of functions, functions are made up of statements and declarations surrounded by curly braces { }.

The basic building block in a C program is the *function*. Every C program is a collection of one or more functions, written in some arbitrary order. One and only one of these functions in the program must have the name `main()`. This function is always the starting point of a C program, so the simplest C program would be just a single function definition:

```
main ()  
  
{  
  
}
```

The parentheses '(')' which follow the name of the function must be included even though they apparently serve no purpose at this stage. This is how C distinguishes functions from ordinary variables.

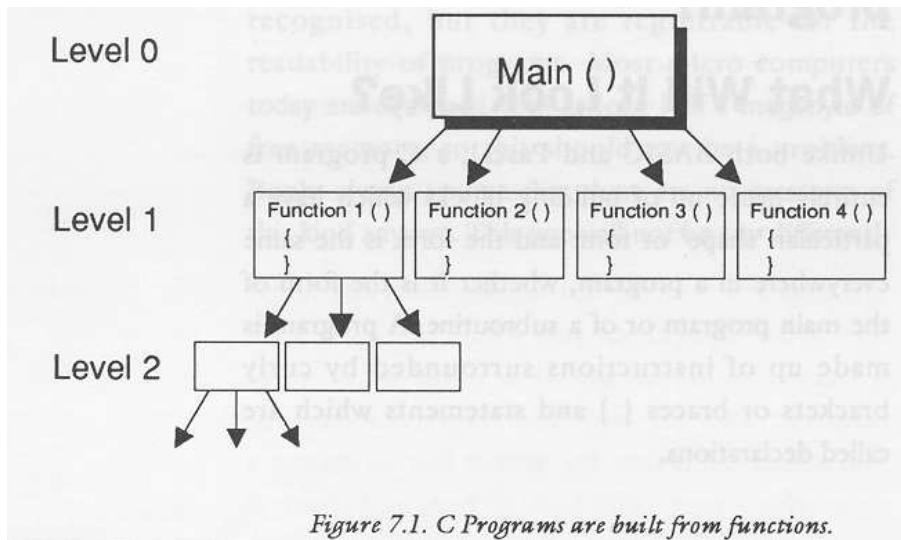

*Figure 7.1. C Programs are built from functions.*

The function `main()` does not have to be at the top of a program so a C program does not necessarily start at line 1. It always starts where `main()`

is. Also, the function `main()` cannot be called from any other function in the program. Only the operating system can call the function `main()`: this is how a C program is started.

The next most simple C program is perhaps a program which calls a function `do_nothing` and then ends.

```

/*****/
/*                                     */
/* Program : do nothing                */
/*                                     */
/*****/

main()                                /* Main program */

{
do_nothing();
}

/*****/

do_nothing()                          /* Function called */

{
}

```

The program now consists of two functions, one of which is called by the other. There are several new things to notice about this program. Firstly the function `do_nothing()` is called by typing its name followed by the characteristic ‘( )’ brackets and a semi-colon. This is all that is required to transfer control to the new function. In some languages, words like `CALL` or `PROC` are used, or even a symbol like ‘&’. No such thing is needed in C. The semi-colon is vital however. All instructions in C must end with a semi-colon. This is a signal to inform the compiler that the end of a statement has been reached and that anything which follows is meant to be a part of another statement. This helps the compiler diagnose errors.

The ‘brace’ characters ‘{’ and ‘}’ mark out a *block* into which instructions are written. When the program meets the closing brace ‘}’ it then transfers back to `main()` where it meets another ‘}’ brace and the program ends. This is the simplest way in which control flows between functions in C. All functions have the same status as far as a program is concerned. The function `main()` is treated just as any other function. When a program is compiled, each function is compiled as a separate entity and then at the end the linker phase in the compiler attempts to sew them all together.

The examples above are obviously very simple but they illustrate how control flows in a C program. Here are some more basic elements which we shall cover.

- comments

- preprocessor commands
- functions
- declarations
- variables
- statements

The skeleton plan of a program, shown below, helps to show how the elements of a C program relate. The following chapters will then expand upon this as a kind of basic plan.

```

/*****
/*
/* Skeleton program plan
/*
/*
/*****

#include <stdio.h>      /* Preprocessor defs */
#include <myfile.c>

#define SCREAM          "arghhhh"
#define NUMBER_OF_BONES 123

/*****

main ()                /* Main program & start */

{ int a,b;              /* declaration */

a=random();
b=function1();
function2(a,b);
}

/*****

function1 ()           /* Purpose */

{
....
}

/*****

function2 (a,b)        /* Purpose */

int a,b;

{
....
}

```

Neither comments nor preprocessor commands have a special place in this list: they do not have to be in any one particular place within the program.

## 6.1 Questions

1. What is a block?
2. Name the six basic things which make up a C program.
3. Does a C program start at the beginning? (Where is the beginning?)
4. What happens when a program comes to a } character? What does this character signify?
5. What vital piece of punctuation goes at the end of every simple C statement?

## 7 Comments

*Annotating programs.*

Comments are a way of inserting remarks and reminders into a program without affecting its content. Comments do not have a fixed place in a program: the compiler treats them as though they were *white space* or blank characters and they are consequently ignored. Programs can contain any number of comments without losing speed. This is because comments are stripped out of a source program by the compiler when it converts the source program into machine code.

Comments are marked out or *delimited* by the following pairs of characters:

```
/* ..... comment .....*/
```

Because a comment is skipped over as though it were a single space, it can be placed anywhere where spaces are valid characters, even in the middle of a statement, though this is not to be encouraged. You should try to minimize the use of comments in a program while trying to maximize the readability of the program. If there are too many comments you obscure your code and it is the code which is the main message in a program.

### 7.1 Example 1

```
main () /* The almost trivial program */
{
    /* This little line has no effect */
    /* This little line has none */
    /* This little line went all the way down
       to the next line */
    /* And so on ... */
}
```

### 7.2 Example 2

```
#include <stdio.h> /* header file */

#define NOTFINISHED 0

/*****
```

```
/* A bar like the one above can be used to */
/* separate functions visibly in a program */

main ()

{ int i;          /* declarations */

do

    {
    /* Nothing !!! */
    }

while (NOTFINISHED);

}
```

### 7.3 Question

1. What happens if a comment is not ended? That is if the programmer types `/*` .. to start but forgets the `*/` to close?



## 8 Functions

*Making black boxes. Solving problems. Getting results.*

A function is a module or block of program code which deals with a particular task. Making functions is a way of isolating one block of code from other independent blocks of code. Functions serve two purposes. They allow a programmer to say: ‘this piece of code does a specific job which stands by itself and should not be mixed up with anything else’, and they make a block of code *reusable* since a function can be reused in many different contexts without repeating parts of the program text.

Functions help us to organize a program in a simple way; in Kernighan & Ritchie C they are always written in the following form:

```

identifier (parameter1,parameter2,..)

types of parameters

{ variable declarations

statements..
.....
....
}

```

For example

```

Pythagoras(x,y,z)

double x,y,z;

{ double d;

d = sqrt(x*x+y*y+z*z);

printf("The distance to your point was %f\n",d);
}

```

In the newer ANSI standard, the same function is written slightly differently:

```

Pythagoras(double x, double y, double z)

{ double d;

d = sqrt(x*x+y*y+z*z);

printf("The distance to your point was %f\n",d);
}

```

You will probably see both styles in C programs.

Each function has a name or identifier by which is used to refer to it in a program. A function can accept a number of *parameters* or values which pass information from outside, and consists of a number of statements and declarations, enclosed by curly braces { }, which make up the doing part of the object. The declarations and ‘type of parameter’ statements are formalities which will be described in good time.

The name of a function in C can be anything from a single letter to a long word. The name of a function must begin with an alphabetic letter or the underscore ‘\_’ character but the other characters in the name can be chosen from the following groups:

- a .. z        (any letter from a to z)
- A .. Z        (any letter from A to Z)
- 0 .. 9        (any digit from 0 to 9)
- \_            (the underscore character)

This means that sensible names can easily be chosen for functions making a program easy to read. Here is a real example function which adds together two integer numbers *a* and *b* and prints the result *c*. All the variables are chosen to be integers to keep things simple and the result is printed out using the print-formatted function `printf`, from the the standard library, with a `"%d"` to indicate that it is printing a integer.

```

Add_Two_Numbers (a,b)                    /* Add a and b */

int a,b;

{ int c;

c = a + b;
printf ("%d",c);

}

```

Notice the position of the function name and where braces and semi-colons are placed: they are crucial. The details are quickly learned with practice and experience.

This function is not much use standing alone. It has to be called from somewhere. A function is *called* (i.e. control is passed to the function) by using its name with the usual brackets () to follow it, along with the values which are to be passed to the function:

```

main ()

{ int c,d;

c = 1;

```

```

d = 53;

Add_Two_Numbers (c,d);
Add_Two_Numbers (1,2);

}

```

The result of this program would be to print out the number 54 and then the number 3 and then stop. Here is a simple program which makes use of some functions in a playful way. The structure diagram shows how this can be visualized and the significance of the program 'levels'. The idea is to illustrate the way in which the functions connect together:

## 8.1 Structure diagram

```

Level 0:      main ()
                |
Level 1:      DownOne ()
                /  \
Level 2:  DownLeft()  DownRight()

```

Note: not all functions fit into a tidy hierarchy like these. Some functions call themselves, while others can be called from anywhere in a program. Where would you place the `printf` function in this hierarchy?

## 8.2 Program Listing

```

/*****
/*
/* Function Snakes & Ladders
/*
/*
*****/

#include <stdio.h>

/*****
/* Level 0
*****/

main ()

{
printf ("This is level 0: the main program\n");

```

```

printf ("About to go down a level      \n");

DownOne ();

printf ("Back at the end of the start!!\n");
}

/*****
/* Level 1 */
*****/

DownOne ()          /* Branch out! */

{
printf ("Down here at level 1, all is well\n");

DownLeft (2);
printf ("Through level 1...\n");
DownRight (2);

printf ("Going back up a level!\n");
}

/*****
/* Level 2 */
*****/

DownLeft (a)       /* Left branch */

int a;

{
printf ("This is deepest level %d\n",a);
printf ("On the left branch of the picture\n");
printf ("Going up!!");
}

/*****
/* Right branch */
*****/

DownRight (a)

int a;

{
printf ("And level %d again!\n",a);
}

```

### 8.3 Functions with values

In other languages and in mathematics a function is understood to be something which produces a value or a number. That is, the whole function is

thought of as having a value. In C it is possible to choose whether or not a function will have a value. It is possible to make a function hand back a value to the place at which it was called. Take the following example:

```
bill = CalculateBill(data...);
```

The variable `bill` is assigned to a function `CalculateBill()` and `data` are some data which are passed to the function. This statement makes it look as though `CalculateBill()` is a number. When this statement is executed in a program, control will be passed to the function `CalculateBill()` and, when it is done, this function will then hand control back. The value of the function is assigned to "bill" and the program continues. Functions which work in this way are said to *return* a value.

In C, returning a value is a simple matter. Consider the function `CalculateBill()` from the statement above:

```
CalculateBill(starter,main,dessert) /* Adds up values */

int starter,main,dessert;

{ int total;

total = starter + main + dessert;
return (total);
}
```

As soon as the `return` statement is met `CalculateBill()` stops executing and assigns the value `total` to the function. If there were no `return` statement the program could not know which value it should associate with the name `CalculateBill` and so it would not be meaningful to speak of the function as having one value. Forgetting a `return` statement can ruin a program. For instance if `CalculateBill` had just been:

```
CalculateBill (starter,main,dessert) /* WRONG! */

int starter,main,dessert;

{ int total;

total = starter + main + dessert;
}
```

then the value `bill` would just be garbage (no predictable value), presuming that the compiler allowed this to be written at all. On the other hand if the first version were used (the one which did use the `return(total)` statement) and furthermore no assignment were made:

```
main ()
```

```

{
  CalculateBill (1,2,3);
}

```

then the value of the function would just be discarded, quite legitimately. This is usually what is done with the input output functions `printf()` and `scanf()` which actually return values. So a function in C can return a value but it does not have to be used; on the other hand, a value which has not been returned cannot be used safely.

*NOTE : Functions do not have to return integers: you can decide whether they should return a different data type, or even no value at all. (See next chapter)*

## 8.4 Breaking out early

Suppose that a program is in the middle of some awkward process in a function which is not `main()`, perhaps two or three loops working together, for example, and suddenly the function finds its answer. This is where the beauty of the `return` statement becomes clear. The program can simply call `return(value)` anywhere in the function and control will jump out of any number of loops or whatever and pass the value back to the calling statement without having to finish the function up to the closing brace `}`.

```

myfunction (a,b)    /* breaking out of functions early */

int a,b;

{
while (a < b)
  {
  if (a > b)
    {
    return (b);
    }
  a = a + 1;
  }
}

```

The example shows this. The function is entered with some values for `a` and `b` and, assuming that `a` is less than `b`, it starts to execute one of C's loops called `while`. In that loop, is a single `if` statement and a statement which increases `a` by one on each loop. If `a` becomes bigger than `b` at any point the `return(b)` statement gets executed and the function `myfunction` quits, without having to arrive at the end brace `}`, and passes the value of `b` back to the place it was called.

## 8.5 The `exit()` function

The function called `exit()` can be used to terminate a program at any point, no matter how many levels of function calls have been made. This is called with a return code, like this:

```
#define CODE 0

exit (CODE);
```

This function also calls a number of other functions which perform tidy-up duties such as closing open files etc.

## 8.6 Functions and Types

All the variables and values used up to now have been integers. But what happens if a function is required to return a different kind of value such as a character? A statement like:

```
bill = CalculateBill (a,b,c);
```

can only make sense if the variable `bill` and the value of the function `CalculateBill()` are the same kind of object: in other words if `CalculateBill()` returns a floating point number, then `bill` cannot be a character! Both sides of an assignment must match.

In fact this is done by declaring functions to return a particular type of data. So far no declarations have been needed because C assumes that all values are integers unless you specifically choose something different. Declarations are covered in the next section.

## 8.7 Questions

1. Write a function which takes two values  $a$  and  $b$  and returns the value of  $(a*b)$ .
2. Is there anything wrong with a function which returns no value?
3. What happens if a function returns a value but it is not assigned to anything?
4. What happens if a function is assigned to an object but that function returns no value?
5. How can a function be made to quit early?





## 9 Variables, Types and Declarations

*Storing data. Discriminating types. Declaring data.*

A variable is a sequence of program code with a name (also called its *identifier*). A name or identifier in C can be anything from a single letter to a word. The name of a variable must begin with an alphabetic letter or the underscore ‘\_’ character but the other characters in the name can be chosen from the following groups:

- a .. z        (any letter from a to z)
- A .. Z        (any letter from A to Z)
- 0 .. 9        (any digit from 0 to 9)
- \_            (the underscore character)

Some examples of valid variable names are:

```
a total Out_of_Memory VAR integer etc...
```

In C variables do not only have names: they also have types. The *type* of a variable conveys to the the compiler what sort of data will be stored in it. In BASIC and in some older, largely obsolete languages, like PL/1, a special naming convention is used to determine the sort of data which can be held in particular variables. e.g. the dollar symbol ‘\$’ is commonly used in BASIC to mean that a variable is a string and the percentage ‘%’ symbol is used to indicate an integer. No such convention exists in C. Instead we specify the types of variables in their declarations. This serves two purposes:

- It gives a compiler precise information about the amount of memory that will have to be given over to a variable when a program is finally run and what sort of arithmetic will have to be used on it (e.g. integer only or floating point or none).
- It provides the compiler with a list of the variables in a convenient place so that it can cross check names and types for any errors.

There is a lot of different possible types in C. In fact it is possible for us to define our own, but there is no need to do this right away: there are some basic types which are provided by C ready for use. The names of these types are all reserved words in C and they are summarized as follows:

- `char`        A single ASCII character
- `short`       A short integer (usually 16-bits)
- `short int`   A short integer
- `int`         A standard integer (usually 32-bits)

<code>long</code>	A long integer
<code>long int</code>	A long integer (usually 32-bits, but increasingly 64 bits)
<code>float</code>	A floating point or real number (short)
<code>long float</code>	a long floating point number
<code>double</code>	A long floating point number
<code>void</code>	Discussed in a later chapter.
<code>enum</code>	Discussed in a later chapter.
<code>volatile</code>	Discussed in a later chapter.

There is some repetition in these words. In addition to the above, the word `unsigned` can also be placed in front of any of these types. Unsigned means that only positive or zero values can be used. (i.e. there is no minus sign). The advantage of using this kind of variable is that storing a minus sign takes up some memory, so that if no minus sign is present, larger numbers can be stored in the same kind of variable. The ANSI standard also allows the word `signed` to be placed in front of any of these types, so indicate the opposite of unsigned. On some systems variables are signed by default, whereas on others they are not.

## 9.1 Declarations

To declare a variable in a C program one writes the *type* followed by a list of variable *names* which are to be treated as being that type:

```
typename variablename1,...,variablenameN;
```

For example:

```
int i,j;
char ch;
double x,y,z,fred;
unsigned long int Name_of_Variable;
```

Failing to declare a variable is more risky than passing through customs and failing to declare your six tonnes of Swiss chocolate. A compiler is markedly more efficient than a customs officer: it will catch a missing declaration every time and will terminate a compiling session whilst complaining bitterly, often with a host of messages, one for each use of the undeclared variable.

## 9.2 Where to declare things

There are two kinds of place in which declarations can be made, See Chapter 11 [Scope], page 65. For now it will do to simply state what these places are.

1. One place is outside all of the functions. That is, in the space between function definitions. (After the `#include` lines, for example.) Variables declared here are called global variables. There are also called static and external variables in special cases.)

```
#include <stdio.h>

int globalinteger;          /* Here! outside {} */

float global_floating_point;

main ()

{
}
```

2. The other place where declarations can be made is following the opening brace, `{}`, of a block. Any block will do, as long as the declaration follows immediately after the opening brace. Variables of this kind only work inside their braces `{}` and are often called local variables. Another name for them is automatic variables.

```
main ()

{ int a;
  float x,y,z;

  /* statements */

}
```

OR

```
function ()

{ int i;

  /* .... */

while (i < 10)
  { char ch;
    int g;

    /* ... */
  }
}
```

## 9.3 Declarations and Initialization

When a variable is declared in C, the language allows a neat piece of syntax which means that variables can be declared and assigned a value in one go. This is no more efficient than doing it in two stages, but it is sometimes tidier. The following:

```
int i = 0;

char ch = 'a';
```

are equivalent to the more longwinded

```
int i;
char ch;

i = 0;
ch = 'a';
```

This is called *initialization* of the variables. C always allows the programmer to write declarations/initializers in this way, but it is not always desirable to do so. If there are just one or two declarations then this initialization method can make a program neat and tidy. If there are many, then it is better to initialize separately, as in the second case. A lot means when it starts to look as though there are too many. It makes no odds to the compiler, nor (ideally) to the final code whether the first or second method is used. It is only for tidiness that this is allowed.

## 9.4 Individual Types

### 9.4.1 char

A character type is a variable which can store a single ASCII character. Groups of `char` form strings. In C single characters are written enclosed by single quotes, e.g. `'c'`! (This is in contrast to strings of many characters which use double quotes, e.g. `"string"`) For instance, if `ch` is the name of a character:

```
char ch;

ch = 'a';
```

would give `ch` the value of the character `a`. The same effect can also be achieved by writing:

```
char ch = 'a';
```

A character can be any ASCII character, printable or not printable from values -128 to 127. (But only 0 to 127 are used.) Control characters i.e. non printable characters are put into programs by using a backslash \ and a special character or number. The characters and their meanings are:

'\b'	backspace BS
'\f'	form feed FF (also clear screen)
'\n'	new line NL (like pressing return)
'\r'	carriage return CR (cursor to start of line)
'\t'	horizontal tab HT
'\v'	vertical tab (not all versions)
'\"'	double quotes (not all versions)
'\''	single quote character '
'\\'	backslash character \
'\ddd'	character <i>ddd</i> where <i>ddd</i> is an ASCII code given in octal or base 8, See <a href="#">(undefined) [Character Conversion Table]</a> , page <a href="#">(undefined)</a> .
'\xddd'	character <i>ddd</i> where <i>ddd</i> is an ASCII code given in hexadecimal or base 16, See <a href="#">(undefined) [Character Conversion Table]</a> , page <a href="#">(undefined)</a> .

## 9.4.2 Listing

```

/*****
/*
/* Special Characters
/*
/*****

#include <stdio.h>

main ()

{
printf ("Beep! \7 \n");
printf ("ch = \'a\' \n");
printf (" <- Start of this line!! \r");
}

```

The output of this program is:

```

Beep! (and the BELL sound )
ch = 'a'
<- Start of this line!!

```

and the text cursor is left where the arrow points. It is also possible to have the type:

```
unsigned char
```

This admits ASCII values from 0 to 255, rather than -128 to 127.

### 9.4.3 Integers

## 9.5 Whole numbers

There are five integer types in C and they are called `char`, `int`, `long`, `long long` and `short`. The difference between these is the size of the integer which either can hold and the amount of storage required for them. The sizes of these objects depend on the operating system of the computer. Even different flavours of Unix can have varying sizes for these objects. Usually, the two to remember are `int` and `short`. `int` means a ‘normal’ integer and `short` means a ‘short’ one, not that that tells us much. On a typical 32 bit microcomputer the size of these integers is the following:

Type	Bits	Possible Values
<code>short</code>	16	-32768 to 32767
<code>unsigned short</code>	16	0 to 65535
<code>int</code>	32	-2147483648 to 2147483647
<code>long</code>	32	(ditto)
<code>unsigned int</code>	32	0 to 4294967295
<code>long long</code>	64	-9e18 to + 8e18

Increasingly though, 64 bit operating systems are appearing and long integers are 64 bits long. You should always check these values. Some mainframe operating systems are completely 64 bit, e.g. Unicos has no 32 bit values. Variables are declared in the usual way:

```
int i,j;
```

```
i = j = 0;
```

or

```
short i=0,j=0;
```

### 9.5.1 Floating Point

There are also long and short floating point numbers in C. All the mathematical functions which C can use require `double` or `long float` arguments

so it is common to use the type `float` for storage only of small floating point numbers and to use `double` elsewhere. (This not always true since the C 'cast' operator allows temporary conversions to be made.) On a typical 32 bit implementation the different types would be organized as follows:

Type	Bits	Possible Values
<code>float</code>	32	+/- 10E-37 to +/- 10E38
<code>double</code>	64	+/- 10E-307 to +/- 10E308
<code>long float</code>	32	(ditto)
<code>long double</code>	???	

Typical declarations:

```
float x,y,z;
x = 0.1;
y = 2.456E5
z = 0;

double bignum,smallnum;
bignum = 2.36E208;
smallnum = 3.2E-300;
```

## 9.6 Choosing Variables

The sort of procedure that you would adopt when choosing variable names is something like the following:

- Decide what a variable is for and what type it needs to be.
- Choose a sensible name for the variable.
- Decide where the variable is allowed to exist.
- Declare that name to be a variable of the chosen type.

Some local variables are only used temporarily, for controlling loops for instance. It is common to give these short names (single characters). A good habit to adopt is to keep to a consistent practice when using these variables. A common one, for instance is to use the letters:

```
int i,j,k;
```

to be integer type variables used for counting. (There is not particular reason why this should be; it is just common practice.) Other integer values should have more meaningful names. Similarly names like:

```
double x,y,z;
```

tend to make one think of floating point numbers.

## 9.7 Assigning variables to one another

Variables can be assigned to numbers:

```
var = 10;
```

and assigned to each other:

```
var1 = var2;
```

In either case the objects on either side of the = symbol must be of the same type. It is possible (though not usually sensible) to assign a floating point number to a character for instance. So

```
int a, b = 1;

a = b;
```

is a valid statement, and:

```
float x = 1.4;
char ch;

ch = x;
```

is a valid statement, since the truncated value 1 can be assigned to `ch`. This is a questionable practice though. It is unclear why anyone would choose to do this. Numerical values and characters will interconvert because characters are stored by their ASCII codes (which are integers!) Thus the following will work:

```
int i;
char ch = 'A';

i = ch;

printf ("The ASCII code of %c is %d",ch,i);
```

The result of this would be:

```
The ASCII code of A is 65
```

## 9.8 Types and The Cast Operator

It is worth mentioning briefly a very valuable operator in C: it is called the cast operator and its function is to convert one type of value into another. For instance it would convert a character into an integer:



```
int i;  
char ch = '\n';  
  
i = (int) ch;
```

The value of the integer would be the ASCII code of the character. This is the only integer which it would make any sense to talk about in connection with the character. Similarly floating point and integer types can be interconverted:

```
float x = 3.3;  
int i;  
  
i = (int) x;
```

The value of `i` would be 3 because an integer cannot represent decimal points, so the cast operator rounds the number. There is no such problem the other way around.

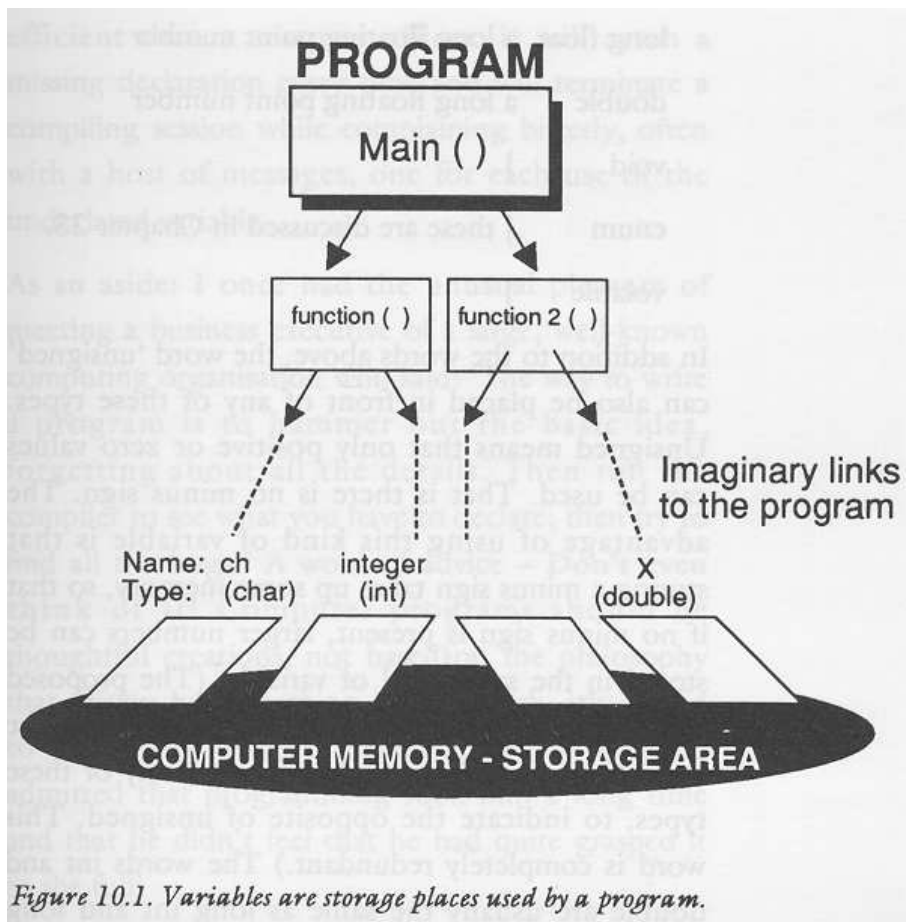

Figure 10.1. Variables are storage places used by a program.

```
float x;
int i = 12;

x = (float) i;
```

The general form of the cast operator is therefore:

`(type) variable`

It does not always make sense to convert types. This will be seen particularly with regard to structures and unions. Cast operators crop up in many areas of C. This is not the last time they will have to be explained.

```

/*****
/*
/* Demo of Cast operator
/*
/*
*****/

#include <stdio.h>

main ()          /* Use int float and char */

{ float x;
  int i;
  char ch;

x = 2.345;
i = (int) x;
ch = (char) x;
printf ("From float x =%f i =%d ch =%c\n",x,i,ch);

i = 45;
x = (float) i;
ch = (char) i;
printf ("From int i=%d x=%f ch=%c\n",i,x,ch);

ch = '*';
i = (int) ch;
x = (float) ch;
printf ("From char ch=%c i=%d x=%f\n",ch,i,x);
}

```

## 9.9 Storage class `static` and `extern`

Sometimes C programs are written in more than one text file. If this is the case then, on occasion, it will be necessary to get at variables which were defined in another file. If the word `extern` is placed in front of a variable then it can be referenced across files:

<i>File 1</i>	<i>File 2</i>
	<code>int i;</code>
<code>main ()</code>	<code>function ()</code>
<code>{</code>	<code>{</code>
<code>extern int i;</code>	
<code>}</code>	<code>}</code>

In this example, the function `main()` in file 1 can use the variable `i` from the function `main` in file 2.

Another class is called `static`. The name `static` is given to variables which can hold their values between calls of a function: they are allocated once and once only and their values are preserved between any number of function calls. Space is allocated for static variables in the program code itself and it is never disposed of unless the whole program is. NOTE: Every global variable, defined outside functions has the type `static` automatically. The opposite of `static` is `auto`.

## 9.10 Functions, Types and Declarations

Functions do not always have to return values which are integers despite the fact that this has been exclusively the case up to now. Unless something special is done to force a function to return a different kind of value C will always assume that the type of a function is `int`.

If you want this to be different, then a function has to be declared to be a certain type, just as variables have to be. There are two places where this must be done:

- The name of the function must be declared a certain type where the function is declared. e.g. a function which returns a float value must be declared as:

```
float function1 ()
{
    return (1.229);
}
```

A function which returns a character:

```
char function2 ()
{
    return (*');
}
```

- As well as declaring a function's identifier to be a certain type in the function definition, it must (irritatingly) be declared in the function in which it is called too! The reasons for this are related to the way in which C is compiled. So, if the two functions above were called from `main()`, they would have to be declared in the variables section as:

```
main ()
{
    char ch, function2 ();
    float x, function1 ();
}
```

```
x = function1 ();  
ch = function2 ();  
}
```

If a function whose type is not integer is not declared like this, then compilation errors will result! Notice also that the function must be declared inside every function which calls it, not just `main()`.

## 9.11 Questions

1. What is an identifier?
2. Say which of the following are valid C identifiers:
  1. `Ralph23`
  2. `80shillings`
  3. `mission_control`
  4. `A%`
  5. `A$`
  6. `_off`
3. Write a statement to declare two integers called `i` and `j`.
4. What is the difference between the types `float` and `double`.
5. What is the difference between the types `int` and `unsigned int`?
6. Write a statement which assigns the value 67 to the integer variable "I".
7. What type does a C function return by default?
8. If we want to declare a function to return `long float`, it must be done in, at least, two places. Where are these?
9. Write a statement, using the cast operator, to print out the integer part of the number 23.1256.
10. Is it possible to have an automatic global variable?



## 10 Parameters and Functions

*Ways in and out of functions.*

Not all functions will be as simple as the ones which have been given so far. Functions are most useful if they can be given information to work with and if they can reach variables and data which are defined outside of them. Examples of this have already been seen in a limited way. For instance the function `CalculateBill` accepted three values `a`, `b` and `c`.

```
CalculateBill (a,b,c)

int a,b,c;

{ int total;

total = a + b + c;
return total;
}
```

When variable values are handed to a function, by writing them inside a functions brackets like this, the function is said to accept parameters. In mathematics a parameter is a variable which controls the behaviour of something. In C it is a variable which carries some special information. In `CalculateBill` the "behaviour" is the addition process. In other words, the value of `total` depends upon the starting values of `a`, `b` and `c`.

Parameters are about communication between different functions in a program. They are like messengers which pass information to and from different places. They provide a way of getting information into a function, but they can also be used to hand information back. Parameters are usually split into two categories: *value* parameters and *variable* parameters. Value parameters are one-way communication carrying information into a function from somewhere outside. Variable parameters are two-way.

### 10.1 Declaring Parameters

A function was defined by code which looks like this:

```
identifier (parameters...)

types of parameters

{

}
```

Parameters, like variables and functions, also have types which must be declared. For instance:

```
function1 (i,j,x,y)

int i,j;
float x,y;

{

}
```

or

```
char function2 (x,ch)

double x;
char ch;

{ char ch2 = '*';

return (ch2);
}
```

Notice that they are declared outside the block braces.

## 10.2 Value Parameters

A value parameter is the most common kind of parameter. All of the examples up to now have been examples of value parameters. When a value parameter is passed information to a function its value is copied to a new place which is completely isolated from the place that the information came from. An example helps to show this. Consider a function which is called from `main()` whose purpose is to add together two numbers and to print out the result.

```
#include <stdio.h>

main ()

{
add (1,4);
}

/*****/

add (a,b)

int a,b;
```



```
{  
printf ("%d", a+b);  
}
```

When this program is run, two new variables are automatically created by the language, called **a** and **b**. The value 1 is copied into **a** and the value 4 is copied into **b**. Obviously if **a** and **b** were given new values in the function **add()** then this could not change the values 1 and 4 in **main()**, because 1

is always 1 and 4 is always 4. They are constants. However if instead the program had been:

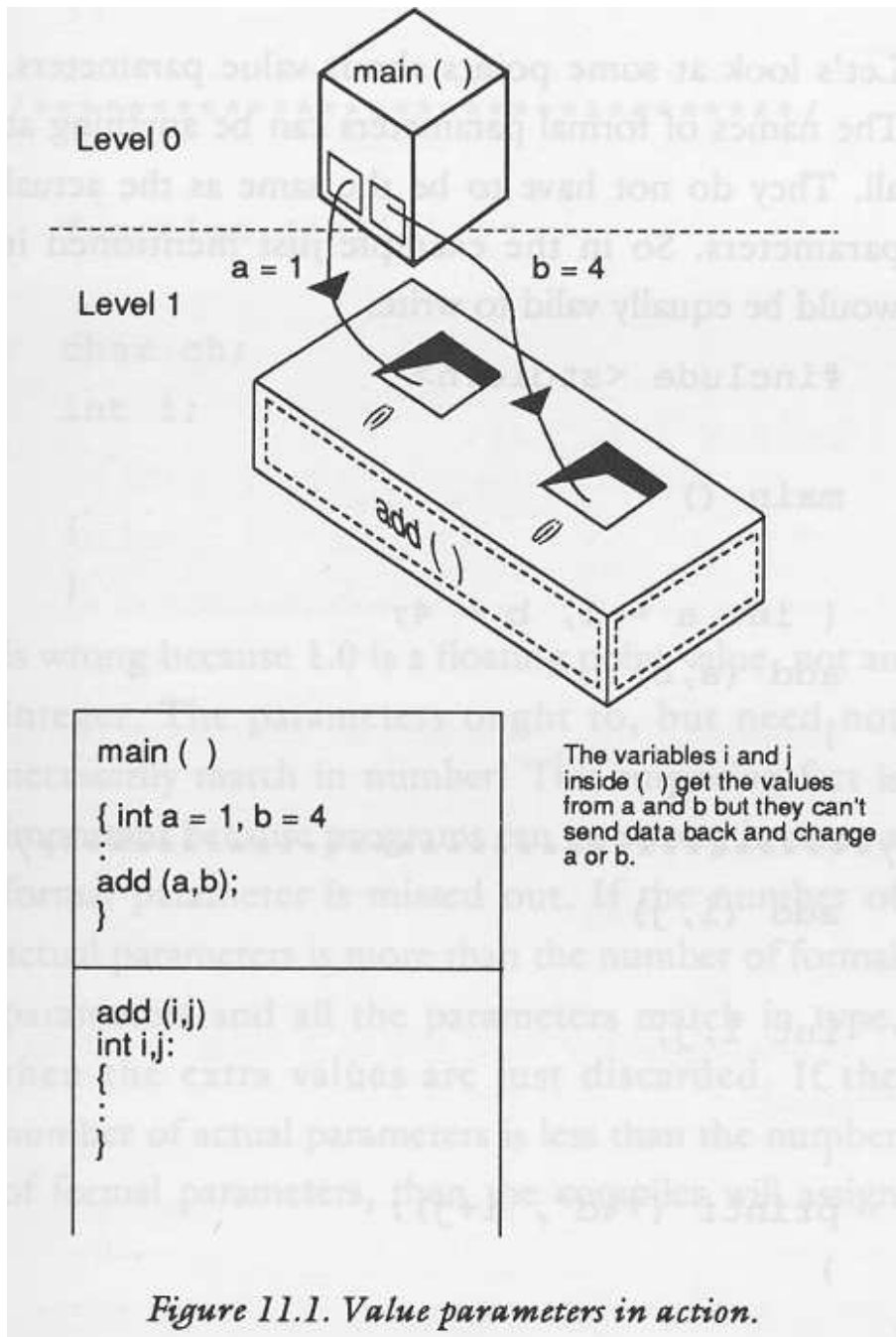

```

main ()

{ int a = 1, b = 4;

add (a,b);
}

/*****/

add (a,b)

int a,b;

{
printf ("%d", a+b);
}

```

then it is less clear what will happen. In fact exactly the same thing happens:

- When `add()` is called from `main()` two new variables `a` and `b` are created by the language (which have nothing to do with the variables `a` and `b` in `main()` and are completely isolated from them).
- The value of `a` in `main()` is copied into the value of `a` in `add()`.
- The value of `b` in `main()` is copied into the value of `b` in `add()`.

Now, any reference to `a` and `b` within the function `add()` refers only to the two parameters of `add` and not to the variables with the same names which appeared in `main()`. This means that if `a` and `b` are altered in `add()` they will not affect `a` and `b` in `main()`. More advanced computing texts have names for the old and they new `a` and `b`:

#### *Actual Parameters*

These are the original values which were handed over to a function. Another name for this is an argument.

#### *Formal Parameters*

These are the copies which work inside the function which was called.

Here are some points about value parameters.

- The names of formal parameters can be anything at all. They do not have to be the same as the actual parameters. So in the example above it would be equally valid to write:

```

#include <stdio.h>

main ()

{ int a = 1, b = 4;

```

```

add (a,b);
}

/*****/

add (i,j)

int i,j;

{
printf ("%d", i+j);
}

```

In this case the value of `a` in `main()` would be copied to the value of `i` in `add()` and the value of `b` in `main()` would be copied to the value of `j` in `add()`.

- The parameters ought to match by datatype when taken in an ordered sequence. It is possible to copy a floating point number into a character formal parameter, causing yourself problems which are hard to diagnose. Some compilers will spot this if it is done accidentally and will flag it as an error. e.g.

```

main ()

{
function ('*',1.0);
}

/*****/

function (ch,i)

char ch;
int i;

{
}

```

is probably wrong because `1.0` is a floating point value, not an integer.

- The parameters ought to, but need not match in number! This surprising fact is important because programs can go wrong if a formal parameter was missed out. ANSI C has a way of checking this by function 'prototyping', but in Kernighan & Ritchie C there is no way to check this. If the number of actual parameters is more than the number of formal parameters and all of the parameters match in type then the extra values are just discarded. If the number of actual parameters is less than the number of formal parameters, then the compiler will assign

some unknown value to the formal parameters. This will probably be garbage.

- Our use of variables as parameters should not leave you with the impression that we can only use variables as parameters. In fact, we can send any literal value, or expression with an appropriate type to a function. For example,

```
sin(3.41415);
cos(a+b*2.0);
strlen("The length of this string");
```

### 10.3 Functions as actual parameters

The value returned by a function can be used directly as a value parameter. It does not have to be assigned to a variable first. For instance:

```
main ()
{
PrintOut (SomeValue());
}

/*****/

PrintOut (a)          /* Print the value */

int a;

{
printf ("%d",a);
}

/*****/

SomeValue ()        /* Return an arbitrary no */

{
return (42);
}
```

This often gives a concise way of passing a value to a function.

### 10.4 Example Listing

```
/*****/
/*                                     */
/* Value Parameters                    */
/*                                     */
/*****/
```

```

    /* Toying with value parameters */

#include <stdio.h>

/*****
/* Level 0
*****/

main ()          /* Example of value parameters */

{ int i,j;
  double x,x_plus_one();
  char ch;

i = 0;
x = 0;

printf (" %f", x_plus_one(x));
printf (" %f", x);

j = resultof (i);

printf (" %d",j);
}

/*****
/* level 1
*****/

double x_plus_one(x)          /* Add one to x ! */

double x;

{
x = x + 1;
return (x);
}

/*****

resultof (j)          /* Work out some result */

int j;

{
return (2*j + 3);          /* why not... */
}

```

## 10.5 Example Listing

```

/*****
/*
/* Program : More Value Parameters
/*
/*
/*****

    /* Print out mock exam results etc */

#include <stdio.h>

/*****

main ()                /* Print out exam results */

{ int pupil1,pupil2,pupil3;
  int ppr1,ppr2,ppr3;
  float pen1,pen2,pen3;

pupil1 = 87;
pupil2 = 45;
pupil3 = 12;

ppr1 = 200;
ppr2 = 230;
ppr3 = 10;

pen1 = 1;
pen2 = 2;
pen3 = 20;

analyse (pupil1,pupil2,pupil3,ppr1,ppr2,
        ppr3,pen1,pen2,pen3);

}

/*****

analyse (p1,p2,p3,w1,w2,w3,b1,b2,b3)

int p1,p2,p3,w1,w2,w3;
float b1,b2,b3;

{
printf ("Pupil 1 scored %d percent\n",p1);
printf ("Pupil 2 scored %d percent\n",p2);
printf ("Pupil 3 scored %d percent\n",p3);

printf ("However: \n");

printf ("Pupil1 wrote %d sides of paper\n",w1);
printf ("Pupil2 wrote %d sides\n",w2);
printf ("Pupil3 wrote %d sides\n",w3);
}

```

```

if (w2 > w1)
{
    printf ("Which just shows that quantity");
    printf (" does not imply quality\n");
}

printf ("Pupil1 used %f biros\n",b1);
printf ("Pupil2 used %f \n",b2);
printf ("Pupil3 used %f \n",b3);

printf ("Total paper used = %d", total(w1,w2,w3));
}

/*****

total (a,b,c)                /* add up total */

int a,b,c;

{
return (a + b + c);
}

```

## 10.6 Variable Parameters

*(As a first time reader you may wish to omit this section until you have read about Pointers and Operators.)*

One way to hand information back is to use the `return` statement. This function is slightly limited however in that it can only hand the value of one variable back at a time. There is another way of handing back values which is less restrictive, but more awkward than this. This is by using a special kind



of parameter, often called a variable parameter. It is most easily explained with the aid of an example:

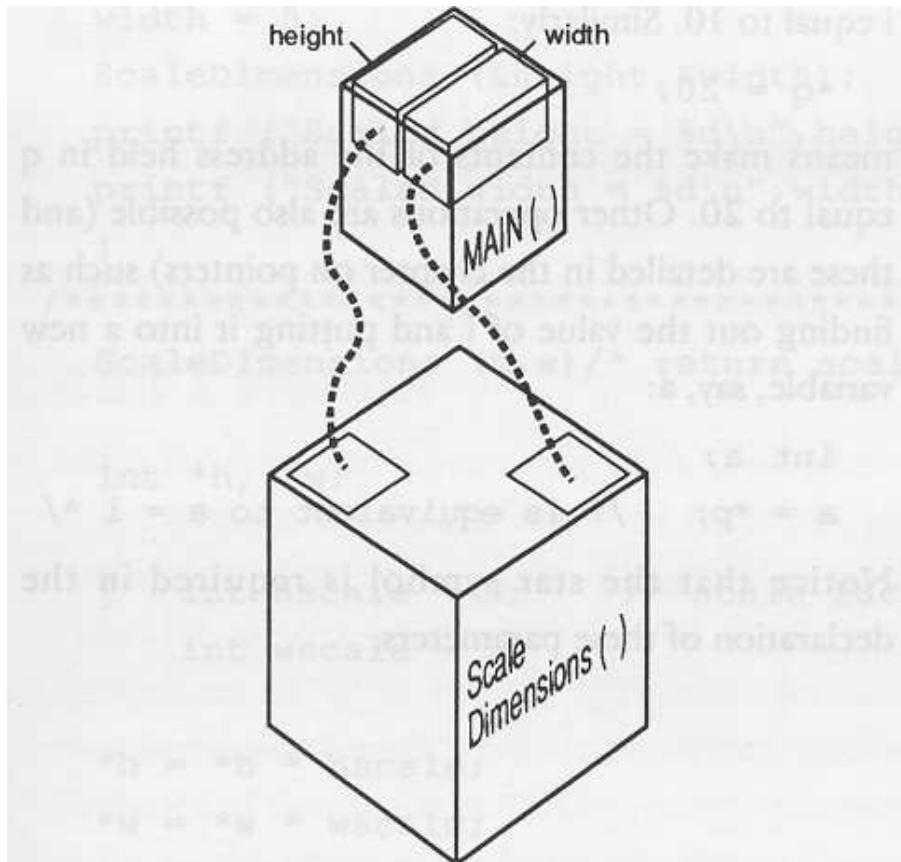

*Figure 11.2 Passing Variables*

**Values can go either way Scale Dimensions() is just connected to the variables in main() directly.**

```
#include <stdio.h>

main ()

{ int i,j;

  GetValues (&i,&j);
```

```

printf ("i = %d and j = %d",i,j)
}

/*****

GetValues (p,q)

int *p,*q;

{
*p = 10;
*q = 20;
}

```

To understand fully what is going on in this program requires a knowledge of pointers and operators, which are covered in later sections, but a brief explanation can be given here, so that the method can be used.

There are two new things to notice about this program: the symbols ‘&’ and ‘\*’. The ampersand ‘&’ symbol should be read as "the address of..". The star ‘\*’ symbol should be read as "the contents of the address...". This is easily confused with the multiplication symbol (which is identical). The difference is only in the context in which the symbol is used. Fortunately this is not ambiguous since multiplication always takes place between two numbers or variables, whereas the "contents of a pointer" applies only to a single variable and the star precedes the variable name.

So, in the program above, it is not the variables themselves which are being passed to the procedure but the addresses of the the variables. In other words, information about where the variables are stored in the memory is passed to the function `GetValues()`. These addresses are copied into two new variables `p` and `q`, which are said to be pointers to `i` and `j`. So, with variable parameters, the function does not receive a copy of the variables themselves, but information about how to get at the original variable which was passed. This information can be used to alter the "actual parameters" directly and this is done with the ‘\*’ operator.

```
*p = 10;
```

means: Make the contents of the address held in `p` equal to 10. Recall that the address held in `p` is the address of the variable `i`, so this actually reads: make `i` equal to 10. Similarly:

```
*q = 20;
```

means make the contents of the address held in `q` equal to 20. Other operations are also possible (and these are detailed in the section on pointers) such as finding out the value of `i` and putting it into a new variable, say, `a`:

```
int a;

a = *p; /* is equivalent to a = i */
```

Notice that the \* symbol is required in the declaration of these parameters.

## 10.7 Example Listing

```

/*****
/*                                     */
/* Program : Variable Parameters      */
/*                                     */
/*****

    /* Scale some measurements on a drawing, say */

#include <stdio.h>

/*****

    main ()                /* Scale measurements*/

    { int height,width;

      height = 4;
      width = 5;

      ScaleDimensions (&height,&width);

      printf ("Scaled height = %d\n",height);
      printf ("Scaled width = %d\n",width);
    }

/*****

    ScaleDimensions (h,w)  /* return scaled values */

    int *h, *w;

    { int hscale = 3;      /* scale factors */
      int wscale = 1;

      *h = *h * hscale;
      *w = *w * wscale;
    }

```

## 10.8 Questions

1. Name two ways that values and results can be handed back from a

function.

2. Where are parameters declared?
3. Can a function be used directly as a value parameter?
4. Does it mean anything to use a function directly as a variable parameter?
5. What do the symbols \* and & mean, when they are placed in front of an identifier?
6. Do actual and formal parameters need to have the same names?

## 11 Scope : Local And Global

*Where a program's fingers can't reach.*

From the computer's point of view, a C program is nothing more than a collection of functions and declarations. Functions can be thought of as sealed capsules of program code which float on a background of *white space*, and are connected together by means of function calls. White space is the name given to the white of an imaginary piece of paper upon which a program is written, in other words the spaces and new line characters which are invisible to the eye. The global white space is only the gaps between functions, not the gaps inside functions. Thinking of functions as sealed capsules is a useful way of understanding the difference between local and global objects and the whole idea of *scope* in a program.

Another analogy is to think of what goes on in a function as being like watching a reality on television. You cannot go in and change the TV reality, only observe the output, but the television show draws its information from the world around it. You can send a parameter (e.g. switch channels) to make some choices. A function called by a function, is like seeing someone watching a television, in a television show.

### 11.1 Global Variables

Global variables are declared in the white space between functions. If every function is a ship floating in this sea of white space, then global variables (data storage areas which also float in this sea) can enter any ship and also enter anything inside any ship (See the diagram). Global variables are available everywhere;. they are created when a program is started and are not destroyed until a program is stopped. They can be used anywhere in a program: there is no restriction about where they can be used, in principle.

### 11.2 Local Variables

Local variables are more interesting. They can not enter just any region of the program because they are trapped inside blocks. To use the ship analogy: if it is imagined that on board every ship (which means inside every function) there is a large swimming pool with many toy ships floating inside, then local variables will work anywhere in the swimming pool (inside any of the toys ships, but can not get out of the large ship into the wide beyond. The swimming pool is just like a smaller sea, but one which is restricted to being inside a particular function. Every function has its own swimming pool! The idea can be taken further too. What about swimming pools onboard the toy ships? (Meaning functions or blocks inside the functions!

```
/* Global white space "sea" */
```

```
function ()  
{  
  /* On board ship */  
  {  
    /* On board a toy ship */  
  }  
}
```

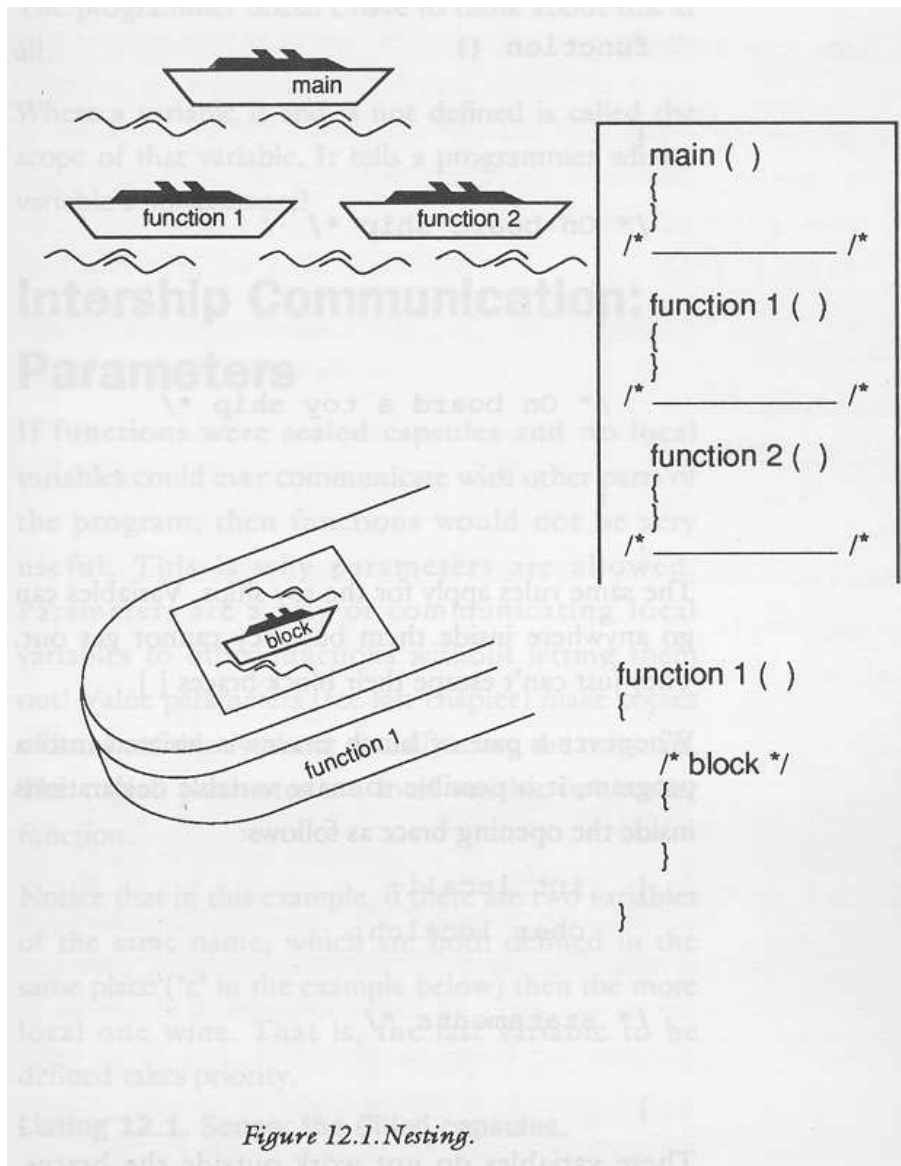

The same rules apply for the toy ships. Variables can reach anywhere inside them but they cannot get out. They cannot escape their block braces `{}`. Whenever a pair of block braces is written into a program it is possible to make variable declarations inside the opening brace. Like this:

```
{ int locali;
```

```

    char localch;

    /* statements */

}

```

These variables do not exist outside the braces. They are only created when the opening brace is encountered and they are destroyed when the closing brace is executed, or when control jumps out of the block. Because they only work in this local area of a program, they are called local variables. It is a matter of style and efficiency to use local variables when it does not matter whether variables are preserved outside of a particular block, because the system automatically allocates and disposes of them. The programmer does not have to think about this.

Where a variable is and is not defined is called the scope of that variable. It tells a programmer what a variables horizons are!

### 11.3 Communication : parameters

If functions were sealed capsules and no local variables could ever communicate with other parts of the program, then functions would not be very useful. This is why parameters are allowed. Parameters are a way of handing local variables to other functions without letting them out! Value parameters (see last section) make copies of local variables without actually using them. The copied parameter is then a local variable in another function. In other words, it can't get out of the function to which is it passed ... unless it is passed on as another parameter.

### 11.4 Example Listing

Notice about the example that if there are two variables of the same name, which are both allowed to be in the same place (c in the example below) then the more local one wins. That is, the last variable to be defined takes priority. (Technically adept readers will realize that this is because it was the last one onto the variable stack.)

```

/*****
/*
/* SCOPE : THE CLLLED CAPSULES
/*
/*
/*****

#include <stdio.h>

/*****

main ()

```



```

{ int a = 1, b = 2, c = 3;

if (a == 1)
    { int c;

      c = a + b;
      printf ("%d",c);
    }

handdown (a,b);
printf ("%d",c);
}

/*****

handdown (a,b)                                /* Some function */

int a,b;

{
...
}

```

## 11.5 Style Note

Some programmers complain about the use of global variables in a program. One complaint is that it is difficult to see what information is being passed to a function unless all that information is passed as parameters. Sometimes global variables are very useful however, and this problem need not be crippling. A way to make this clear is to write global variables in capital letters only, while writing the rest of the variables in mainly small letters..

```

int GLOBALINTEGER;

....

{ int local integer;

}

```

This allows global variables to be spotted easily. Another reason for restricting the use of global variables is that it is easier to debug a program if only local variables are used. The reason is that once a function capsule is tested and sealed it can be guaranteed to work in all cases, provided it is not affected by any other functions from outside. Global variables punch holes in the sealed function capsules because they allow bugs from other functions to creep into tried and tested ones. An alert and careful programmer can usually control this without difficulty.

The following guidelines may help the reader to decide whether to use local or global data:

- Always think of using a local variable first. Is it impractical? Yes, if it means passing dozens of parameters to functions, or reproducing a lot of variables. Global variables will sometimes tidy up a program.
- Local variables make the flow of data in a program clearer and they reduce the amount of memory used by the program when they are not in use.
- The preference in this book is to use local variables for all work, except where a program centres around a single data structure. If a data structure is the main reason for a program's existence, it is nearly always defined globally.

## 11.6 Scope and Style

All the programs in this book, which are longer than a couple of lines, are written in an unusual way: with a *levelled structure*. There are several good reasons for this. One is that the sealed capsules are shown to be sealed, by using a comment bar between each function.

```
/******
```

Another good reason is that any function hands parameters down by only one level at a time and that any `return()` statement hands values up a single level. The global variables are kept to a single place at the head of each program so that they can be seen to reach into everything.

The diagram shows how the splitting of levels implies something about the scope of variables and the handing of parameters.

## 11.7 Questions

1. What is a global variable?
2. What is a local variable?
3. What is meant by calling a block (enclosed by braces `{}` ) a "sealed capsule"?
4. Do parameters make functions leaky? i.e. Do they spoil them by letting the variables leak out into other functions?
5. Write a program which declares 4 variables. Two integer variables called `number_of_hats`, `counter` which are GLOBAL and two float variables called `x_coord`, `y_coord` which are LOCAL inside the function `main()`. Then add another function called `another()` and pass `x_coord`, `y_coord` to this function. How many different storage spaces are used when this program runs? (Hint: are `x_coord`, `y_coord` and their copies the same?)

## 12 Preprocessor Commands

*Making programming versatile.*

C is unusual in that it has a *pre-processor*. This comes from its Unix origins. As its name might suggest, the preprocessor is a phase which occurs prior to compilation of a program. The preprocessor has two main uses: it allows external files, such as header files, to be included and it allows **macros** to be defined. This useful feature traditionally allowed constant values to be defined in Kernighan and Ritchie C, which had no constants in the language.

Pre-processor commands are distinguished by the hash (number) symbol '#'. One example of this has already been encountered for the standard header file 'stdio.h'.

```
#include <stdio.h>
```

is a command which tells the preprocessor to treat the file 'stdio.h' as if it were the actually part of the program text, in other words to include it as part of the program to be compiled.

Macros are words which can be defined to stand in place of something complicated: they are a way of reducing the amount of typing in a program and a way of making long ungainly pieces of code into short words. For example, the simplest use of macros is to give constant values meaningful names: e.g.

```
#define TELEPHNUM 720663
```

This allows us to use the word TELEPHNUM in the program to mean the number 720663. In this particular case, the word is clearly not any shorter than the number it will replace, but it is more meaningful and would make a program read more naturally than if the raw number were used. For instance, a program which deals with several different fixed numbers like a telephone number, a postcode and a street number could write:

```
printf("%d %d %d",TELEPHNUM,postcode,streetnum);
```

instead of

```
printf("%d %d %d",720663,345,14);
```

Using the macros instead makes the actions much clearer and allows the programmer to forget about what the numbers actually are. It also means that a program is easy to alter because to change a telephone number, or whatever, it is only necessary to change the definition, not to retype the number in every single instance.

The important feature of macros is that they are not merely numerical constants which are referenced at compile time, but are strings which are physically replaced before compilation by the preprocessor! This means that almost anything can be defined:

```
#define SUM 1 + 2 + 3 + 4
```

would allow SUM to be used instead of 1+2+3+4. Or

```
#define STRING "Mary had a little lamb..."
```

would allow a commonly used string to be called by the identifier "string" instead of typing it out afresh each time. The idea of a define statement then is:

```
#define macroname definition on rest of line
```

Macros cannot define more than a single line to be substituted into a program but they can be used anywhere, except inside strings. (Anything enclosed in string quotes is assumed to be complete and untouchable by the compiler.) Some macros are defined already in the file 'stdio.h' such as:

EOF           The end of file character (= -1 for instance)

NULL           The null character (zero) = 0

## 12.1 Macro Functions

A more advanced use of macros is also permitted by the preprocessor. This involves macros which accept parameters and hand back values. This works by defining a macro with some dummy parameter, say *x*. For example: a macro which is usually defined in one of the standard libraries is `abs()` which means the absolute or unsigned value of a number. It is defined below:

```
#define ABS(x) ((x) < 0) ? -(x) : (x)
```

The result of this is to give the positive (or unsigned) part of any number or variable. This would be no problem for a function which could accept parameters, and it is, in fact, no problem for macros. Macros can also be made to take parameters. Consider the `ABS()` example. If a programmer were to write `ABS(4)` then the preprocessor would substitute 4 for *x*. If a program read `ABS(i)` then the preprocessor would substitute *i* for *x* and so on. (There is no reason why macros can't take more than one parameter too. The programmer just includes two dummy parameters with different names. See the example listing below.) Notice that this definition uses a curious operator which belongs to C:

```
<test> ? <true result> : <false result>
```



```

#include <stdio.h>

#define STRING1      "A macro definition\n"
#define STRING2      "must be all on one line!!\n"
#define EXPRESSION   1 + 2 + 3 + 4
#define EXPR2        EXPRESSION + 10
#define ABS(x)        ((x) < 0) ? -(x) : (x)
#define MAX(a,b)      (a < b) ? (b) : (a)
#define BIGGEST(a,b,c) (MAX(a,b) < c) ? (c) : (MAX(a,b))

/*****

main ()          /* No #definitions inside functions! */

{
printf (STRING1);
printf (STRING2);
printf ("%d\n",EXPRESSION);
printf ("%d\n",EXPR2);
printf ("%d\n",ABS(-5));
printf ("Biggest of 1 2 and 3 is %d",BIGGEST(1,2,3));
}

```

## 12.4 Note about #include

When an include statement is written into a program, it is a sign that a compiler should merge another file of C programming with the current one. However, the `#include` statement is itself valid C, so this means that a file which is included may contain `#includes` itself. The includes are then said to be "nested". This often makes includes simpler.

## 12.5 Other Preprocessor commands

*This section lies somewhat outside the main development of the book. You might wish to omit it on a first reading.*

There are a handful more preprocessor commands which can largely be ignored by the beginner. They are commonly used in "include" files to make sure that things are not defined twice.

NOTE : 'true' has any non zero value in C. 'false' is zero.

**#undef**      This undefines a macro, leaving the name free.

**#if**            This is followed by some expression on the same line. It allows *conditional compilation*. It is an advanced feature which can be

used to say: only compile the code between ‘`#if`’ and ‘`#endif`’ if the value following ‘`#if`’ is true, else leave out that code altogether. This is different from not executing code—the code will not even be compiled.

- `#ifdef` This is followed by a macro name. If that macro is defined then this is true.
- `#ifndef` This is followed by a macro name. If that name is not defined then this is true.
- `#else` This is part of an `#if`, `#ifdef`, `#ifndef` preprocessor statement.
- `#endif` This marks the end of a preprocessor statement.
- `#line` Has the form:
- `#line constant 'filename'`  
This is for debugging mainly. This statement causes the compiler to believe that the next line is line number (constant) and is part of the file (filename).
- `#error` This is a part of the proposed ANSI standard. It is intended for debugging. It forces the compiler to abort compilation.

## 12.6 Example

```

/*****
/* To compile or not to compile */
*****/

#define SOMEDEFINITION 6546
#define CHOICE 1 /* Choose this before compiling */

/*****

#if (CHOICE == 1)

#define OPTIONSTRING "The programmer selected this"
#define DITTO "instead of ..."

#else

#define OPTIONSTRING "The alternative"
#define DITTO "i.e. This! "

#endif

/*****

#ifdef SOMEDEFINITION

```

```
#define WHATEVER "Something was defined!"

#else

#define WHATEVER "Nothing was defined"

#endif

/*****/

main ()

{
printf (OPTIONSTRING);
printf (DITTO);
}
```

## 12.7 Questions

1. Define a macro called "birthday" which describes the day of the month upon which your birthday falls.
2. Write an instruction to the preprocessor to include to maths library 'math.h'.
3. A macro is always a number. True or false?
4. A macro is always a constant. True or false?



## 13 Pointers

*Making maps of data.*

You have a map (a plan) of the computer's memory. You need to find that essential piece of information which is stored at some unknown location. How will you find it? You need a pointer!

A pointers is a special type of variable which holds the address or location of another variable. Pointers point to these locations by keeping a record of the spot at which they were stored. Pointers to variables are found by recording the address at which a variable is stored. It is always possible to find the address of a piece of storage in C using the special '&' operator. For instance: if `location` were a float type variable, it would be easy to find a pointer to it called `location_ptr`.

```
float location;  
float *location_ptr,*address;  
  
location_ptr = &(amp;location);
```

or

```
address = &(amp;location);
```

The declarations of pointers look a little strange at first. The star '\*' symbol which stands in front of the variable name is C's way of declaring that variable to be a pointer. The four lines above make two identical pointers to a floating point variable called `location`, one of them is called `location_ptr` and the other is called `address`. The point is that a pointer is just a place to keep a record of the address of a variable, so they are really the same thing.

A pointer is a bundle of information that has two parts. One part is the address of the beginning of the segment of memory that holds whatever is pointed to. The other part is the type of value that the pointer points to the beginning of. This tells the computer how much of the memory after the beginning to read and how to interpret it. Thus, if the pointer is of a type `int`, the segment of memory returned will be four bytes long (32 bits) and be interpreted as an integer. In the case of a function, the type is the type of value that the function will return, although the address is the address of the beginning of the function executable.

If, like some modern day programmers, you believe in sanctity of high level languages, it is probably a source of wonder why anyone Would ever want to know the address of these variables. Having gone to the trouble to design a high level language, like C, in which variables can be given elegant and meaningful names: it seems like a step in the backward direction to



1. Declare an `int` type variable called `somevar`.
2. Declare a pointer to an `int` type called `ptr_to_somevar`. The `*` which stands in front of `ptr_to_somevar` is the way C declares `ptr_to_somevar` as a pointer to an integer, rather than an integer.
3. Let `somevar` take the value 42.
4. This gives a value to `ptr_to_somevar`. The value is the address of the variable `somevar`. Notice that only at this stage does it become a pointer to the particular variable `somevar`. Before this, its fate is quite open. The declaration (2) merely makes it a pointer which can point to any integer variable which is around.
5. Print out "the contents of the location pointed to by `ptr_to_somevar`" in other words `somevar` itself. So this will be just 42.
6. Let the contents of the location pointed to by `ptr_to_somevar` be 56. This is the same as the more direct statement:

```
somevar = 56;
```

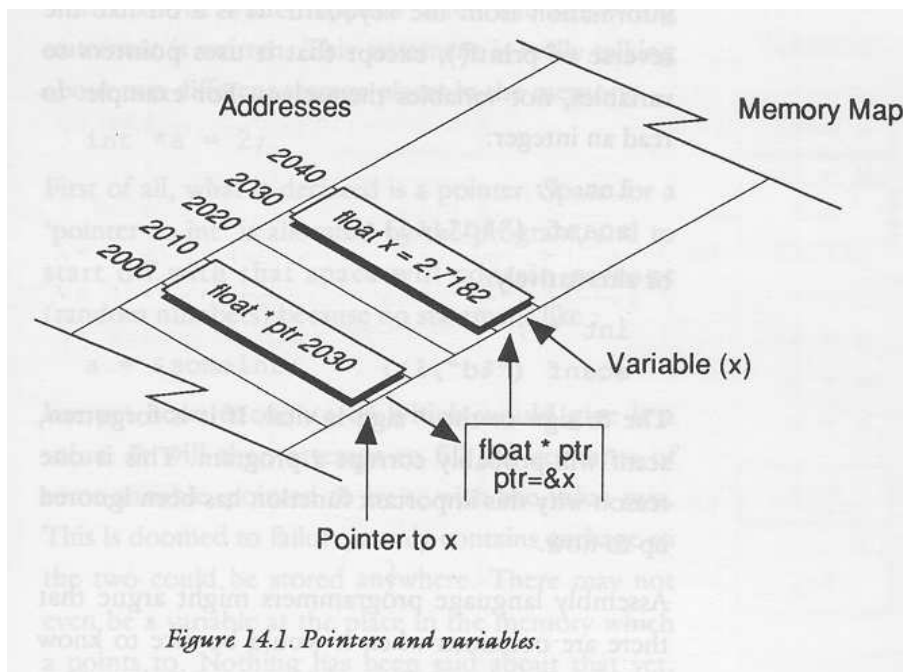

## 13.2 Uses for Pointers

It is possible to have pointers which point to any type of data whatsoever. They are always declared with the `*` symbol. Some examples are given below.

```
int i,*ip;

char ch,*chp;

short s,*sp;

float x,*xp;

double y,*yp;
```

Pointers are extremely important objects in C. They are far more important in C than in, say, Pascal or BASIC (PEEK,POKE are like pointers). In particular they are vital when using data structures like strings or arrays or linked lists. We shall meet these objects in later chapters.

One example of the use of pointers is the C input function, which is called `scanf()`. It is looked at in detail in the next section. `scanf()` is for getting information from the keyboard. It is a bit like the reverse of `printf()`, except that it uses pointers to variables, not variables themselves. For example: to read an integer:

```
int i;
scanf ("%d",&i);
```

or

```
int *i;
scanf ("%d",i);
```

The ‘&’ sign or the ‘\*’ sign is vital. If it is forgotten, `scanf` will probably corrupt a program. This is one reason why this important function has been ignored up to now.

Assembly language programmers might argue that there are occasions on which it would be nice to know the actual address of a variable as a number. One reason why one might want to know this would be for debugging. It is not often a useful thing to do, but it is not inconceivable that in developing some program a programmer would want to know the actual address. The ‘&’ operator is flexible enough to allow this to be found. It could be printed out as an integer:

```
type *ptr:

printf ("Address = %d",(int) ptr);
```

### 13.3 Pointers and Initialization

Something to be wary of with pointer variables is the way that they are initialized. It is incorrect, logically, to initialize pointers in a declaration. A compiler will probably not prevent this however because there is nothing incorrect about it as far as syntax is concerned.

Think about what happens when the following statement is written. This statement is really talking about two different storage places in the memory:

```
int *a = 2;
```

First of all, what is declared is a pointer, so space for a 'pointer to `int`' is allocated by the program and to start off with that space will contain garbage (random numbers), because no statement like

```
a = &someint;
```

has yet been encountered which would give it a value. It will then attempt to fill the contents of some variable, pointed to by `a`, with the value 2. This is doomed to failure. `a` only contains garbage so the 2 could be stored anywhere. There may not even be a variable at the place in the memory which `a` points to. Nothing has been said about that yet. This kind of initialization cannot possibly work and will most likely crash the program or corrupt some other data.

### 13.4 Example Listing

```

/*****
/*
/* Swapping Pointers
/*
/*****

/* Program swaps the variables which a,b */
/* point to. Not pointless really ! */

#include <stdio.h>

main ()

{ int *a,*b,*c;          /* Declr ptrs */
  int  A,B;              /* Declare storage */

  A = 12;                /* Initialize storage */
  B = 9;

  a = &A;                /* Initialize pointers */

```

```
b = &B;

printf ("%d %d\n",*a,*b);

c = a;                /* swap pointers */
a = b;
b = c;

printf ("%d %d\n",*a,*b);

}
```

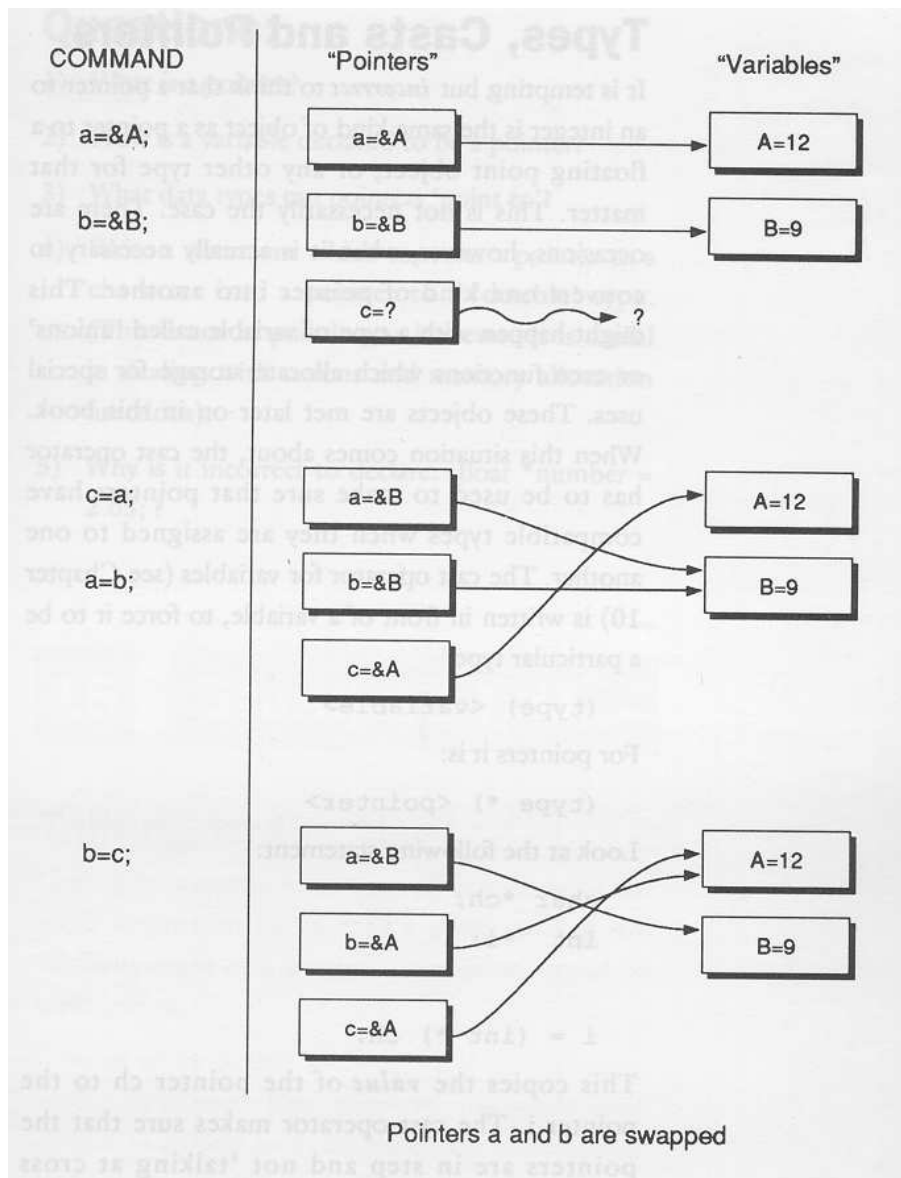

### 13.5 Types, Casts and Pointers

It is tempting but incorrect to think that a pointer to an integer is the same kind of object as a pointer to a floating point object or any other type for that matter. This is not necessarily the case. Compilers distinguish between pointers to different kinds of objects. There are occasions however

when it is actually necessary to convert one kind of pointer into another. This might happen with a type of variable called "unions" or even functions which allocate storage for special uses. These objects are met later on in this book. When this situation comes about, the cast operator has to be used to make sure that pointers have compatible types when they are assigned to one another. The cast operator for variables, See (undefined) [The Cast Operator], page (undefined), is written in front of a variable to force it to be a particular type:

```
(type) variable
```

For pointers it is:

```
(type *) pointer
```

Look at the following statement:

```
char *ch;
int *i;

i = (int *) ch;
```

This copies the value of the pointer `ch` to the pointer `i`. The cast operator makes sure that the pointers are in step and not talking at cross purposes. The reason that pointers have to be 'cast' into shape is a bit subtle and depends upon particular computers. In practice it may not actually do anything, but it is a necessary part of the syntax of C.

Pointer casting is discussed in greater detail in the chapter on Structures and Unions.

## 13.6 Pointers to functions

*This section is somewhat outside of the main development of the book. You might want to omit it on first reading.*

Let's now consider pointers to functions as opposed to variables. This is an advanced feature which should be used with more than a little care. The idea behind pointers to functions is that you can pass a function as a parameter to another function! This seems like a bizarre notion at first but in fact it makes perfect sense.

Pointers to functions enable you to tell any function which sub-ordinate function it should use to do its job. That means that you can plug in a new function in place of an old one just by passing a different parameter value to the function. You do not have to rewrite any code. In machine code circles this is sometimes called indirection or vectoring.



When we come to look at arrays, we'll find that a pointer to the start of an array can be found by using the name of the array itself without the square brackets []. For functions, the name of the function without the round brackets works as a pointer to the start of the function, as long as the compiler understands that the name represents the function and not a variable with the same name. So—to pass a function as a parameter to another function you would write

```
function1(function2);
```

If you try this as it stands, a stream of compilation errors will be the result. The reason is that you must declare `function2()` explicitly like this:

```
int function2();
```

If the function returns a different type then clearly the declaration will be different but the form will be the same. The declaration can be placed together with other declarations. It is not important whether the variable is declared locally or globally, since a function is a global object regardless. What is important is that we declare specifically a pointer to a function which returns a type (even if it is `void`). The function which accepts a function pointer as an argument looks like this:

```
function1 (a)

int (*a)();

{ int i;

  i = (*a)(parameters);
}
```

This declares the formal parameter `a` to be a pointer to a function returning a value of type `int`. Similarly if you want to declare a pointer to a function to a general type `typename` with the name `fnptr`, you would do it like this:

```
typename (*fnptr)();
```

## 13.7 Calling a function by pointer

Given a pointer to a function how do we call the function? The syntax is this:

```
variable = (*fnptr)(parameters);
```

An example let us look at a function which takes an integer and returns a character.

```
int i;
char ch, function();
```

Normally this function is called using the statement:

```
ch = function(i);
```

but we can also do the same thing with a pointer to the function. First define

```
char function();
char (*fnptr)();

fnptr = function;
```

then call the function with

```
ch = (*fnptr)(i);
```

A pointer to a function can be used to provide a kind of plug-in interface to a logical device, i.e. a way of choosing the right function for the job.

```
void printer(),textscreen(),windows();

switch (choice)
{
  case 1: fnptr = printer;
         break;
  case 2: fnptr = textscreen;
         break;
  case 3: fnptr = windows;
         }

Output(data,fnptr);
```

This is the basis of ‘polymorphism’ found in object oriented languages: a choice of a logical (virtual) function based on some abstract label (the choice). The C++ language provides an abstract form of this with a more advanced syntax, but this is the essence of virtual function methods in object oriented languages.

**BEWARE!** A pointer to a function is an automatic local variable. Local variables are never initialized by the compiler in C. If you inadvertently forget to initialize the pointer to a function, you will come quickly to grief. Make sure that your pointers are assigned before you use them!

## 13.8 Questions

1. What is a pointer?
2. How is a variable declared to be a pointer?
3. What data types can pointers "point to"?

4. Write a statement which converts a pointer to a character into a pointer to a `double` type. (This is not as pointless as it seems. It is useful in dealing with unions and memory allocation functions.)
5. Why is it incorrect to declare: `float *number = 2.65; ?`



## 14 Standard Output and Standard Input

*Talking to the user.*

Getting information in and out of a computer is the most important thing that a program can do. Without input and output computers would be quite useless.

C treats all its output as though it were reading or writing to different files. A file is really just an abstraction: a place where information comes from or can be sent to. Some files can only be read, some can only be written to, others can be both read from and written to. In other situations files are called I/O streams.

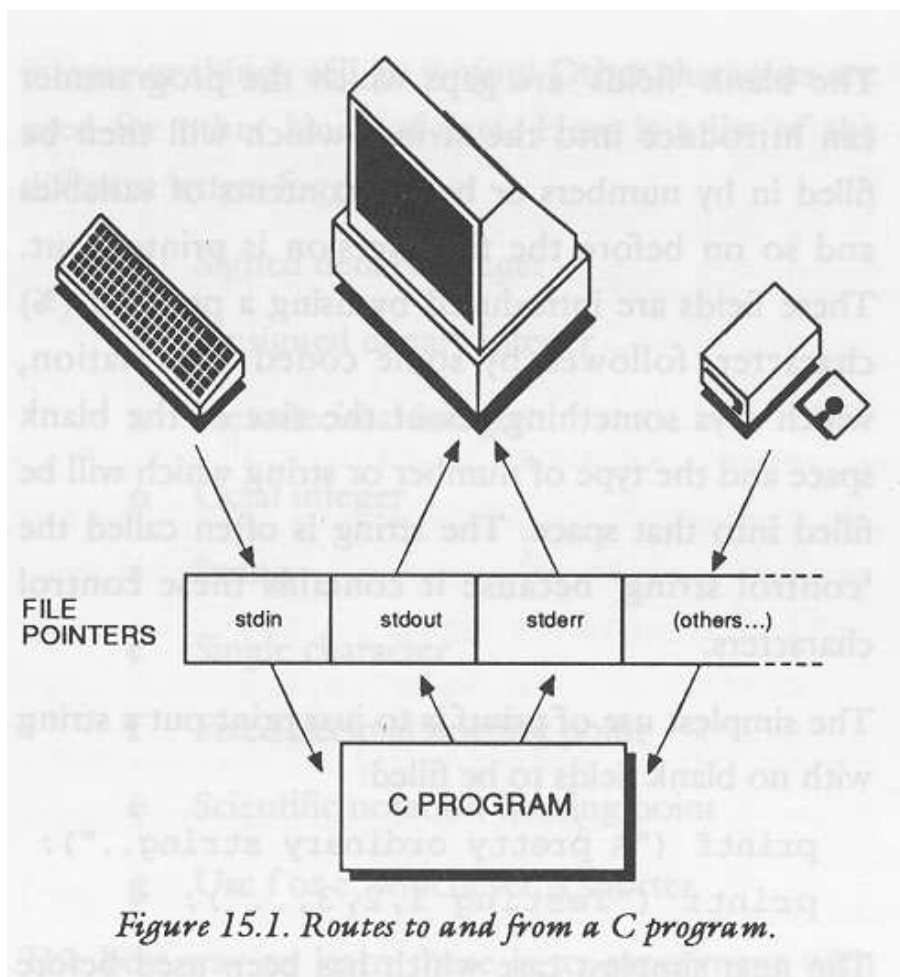

*Figure 15.1. Routes to and from a C program.*

C has three files (also called streams) which are always open and ready for use. They are called *stdin*, *stdout* and *stderr*, meaning standard input and standard output and standard error file. *Stdin* is the input which usually arrives from the keyboard of a computer. *stdout* is usually the screen. *stderr* is the route by which all error messages pass: usually the screen. This is only 'usually' because the situation can be altered. In fact what happens is that these files are just handed over to the local operating system to deal with and it chooses what to do with them. Usually this means the keyboard and the screen, but it can also be redirected to a printer or to a disk file or to a modem etc.. depending upon how the user ran the program.

The keyboard and screen are referred to as the standard input/output files because this is what most people use, most of the time. Also the programmer never has to open or close these, because C does it automatically. The C library functions covered by 'stdio.h' provides some methods for working with *stdin* and *stdout*. They are simplified versions of the functions that can be used on any kind of file, See [\(undefined\)](#) [Files and Devices], page [\(undefined\)](#). In order of importance, they are:

```
printf ()
scanf ()
getchar()
putchar()
gets   ()
puts   ()
```

## 14.1 printf

The `printf` function has been used widely up to now for output because it provides a neat and easy way of printing text and numbers to *stdout* (the screen). Its name is meant to signify formatted printing because it gives the user control over how text and numerical data are to be laid out on the screen. Making text look good on screen is important in programming. C makes this easy by allowing you to decide how the text will be printed in the available space. The `printf` function has general form:

```
printf ("string...",variables,numbers)
```

It contains a string (which is not optional) and it contains any number of parameters to follow: one for each blank field in the string.

The blank fields are control sequences which one can put into the string to be filled in with numbers or the contents of variables before the final result is printed out. These fields are introduced by using a '%' character, followed by some coded information, which says something about the size of the blank space and the type of number or string which will be filled into that space. Often the string is called the control string because it contains these control characters.

The simplest use of `printf` is to just print out a string with no blank fields to be filled:

```
printf ("A pretty ordinary string..");  
printf ("Testing 1,2,3...");
```

The next simplest case that has been used before now is to print out a single integer number:

```
int number = 42;  
printf ("%d",number);
```

The two can be combined:

```
int number = 42;  
printf ("Some number = %d",number);
```

The result of this last example is to print out the following on the screen:

```
Some number = 42
```

The text cursor is left pointing to the character just after the 2. Notice the way that `%d` is swapped for the number 42. `%d` defines a field which is filled in with the value of the variable.

There are other kinds of data than integers though. Any kind of variable can be printed out with `printf`. `%d` is called a conversion character for integers because it tells the compiler to treat the variable to be filled into it as an integer. So it better had be an integer or things will go wrong! Other characters are used for other kinds of data. Here is a list if the different letters for `printf`.

d	signed denary integer
u	unsigned denary integer
x	hexadecimal integer
o	octal integer
s	string
c	single character
f	fixed decimal floating point
e	scientific notation floating point
g	use f or e, whichever is shorter

The best way to learn these is to experiment with different conversion characters. The example program and its output below give some impression of how they work:

## 14.2 Example Listing

```

/*****
/*
/* printf Conversion Characters and Types
/*
/*
*****/

#include <stdio.h>

main ()

{ int i = -10;
  unsigned int ui = 10;
  float x = 3.56;
  double y = 3.52;
  char ch = 'z';
  char *string_ptr = "any old string";

printf ("signed integer %d\n", i);
printf ("unsigned integer %u\n",ui);

printf ("This is wrong! %u",i);
printf ("See what happens when you get the ");
printf ("character wrong!");

printf ("Hexadecimal %x %x\n",i,ui);
printf ("Octal %o %o\n",i,ui);

printf ("Float and double %f %f\n",x,y);
printf ("      ditto      %e %e\n",x,y);
printf ("      ditto      %g %g\n",x,y);

printf ("single character %c\n",ch);
printf ("whole string -> %s",string_ptr);
}

```

## 14.3 Output

```

signed integer -10
unsigned integer 10
This is wrong! 10See what happens when you get the character wrong!Hexadecimal FFFFFFF6 A■
Octal 3777777766 12
Float and double 3.560000 3.520000
ditto      3.560000E+00 3.520000E+00

```



```
ditto      3.560000 3.520000
single character z
whole string -> any old string
```

## 14.4 Formatting with printf

The example program above does not produce a very neat layout on the screen. The conversion specifiers in the printf string can be extended to give more information. The '%' and the character type act like brackets around the extra information. e.g.

```
%-10.3f
```

is an extended version of '%f', which carries some more information. That extra information takes the form:

```
% [-] [fwidth] [.p] x
```

where the each bracket is used to denote that the item is optional and the symbols inside them stand for the following.

- [fwidth] This is a number which specifies the field width of this "blank field". In other words, how wide a space will be made in the string for the object concerned? In fact it is the minimum field width because if data need more room than is written here they will spill out of their box of fixed size. If the size is bigger than the object to be printed, the rest of the field will be filled out with spaces.
- [-] If this included the output will be left justified. This means it will be aligned with the left hand margin of the field created with [fwidth]. Normally all numbers are right justified, or aligned with the right hand margin of the field "box".
- [.p] This has different meanings depending on the object which is to be printed. For a floating point type (float or double) p specifies the number of decimal places after the point which are to be printed. For a string it specifies how many characters are to be printed.

Some valid format specifiers are written below here.

```
%10d %2.2f %25.21s %2.6f
```

The table below helps to show the effect of changing these format controls. The width of a field is draw in by using the | bars.

<i>Object to be printed</i>	<i>Control Spec.</i>	<i>Actual Output</i>
42	%6d	42

42	%-6d	42
324	%10d	324
-1	%-10d	-1
-1	%1d	-1 (overspill)
'z'	%3c	z
'z'	%-3c	z
2.71828	%10f	2.71828
2.71828	%10.2f	2.71
2.71828	%-10.2f	2.71
2.71828	%2.4f	2.7182 (overspill)
2.718	%.4f	2.7180
2.718	%10.5f	2.71800
2.71828	%10e	2.71828e+00
2.71828	%10.2e	2.17e+00
2.71828	%10.2g	2.71
"printf"	%s	printf
"printf"	%10s	printf
"printf"	%2s	printf (overspill)
"printf"	%5.3s	pri
"printf"	%-5.3s	pri
"printf"	%.3s	pri

## 14.5 Example Listing

```

/*****
/*                                     */
/* Multiplication Table                 */
/*                                     */
/*****

#include <stdio.h>

main ()          /* Printing in columns */

{ int i,j;

for (i = 1; i <= 10; i++)
{
    for (j = 1; j <= 10; j++)
    {
        printf ("%5d",i * j);
    }
    printf ("\n");
}
}

```

## 14.6 Output

1	2	3	4	5	6	7	8	9	10
2	4	6	8	10	12	14	16	18	20
3	6	9	12	15	18	21	24	27	30
4	8	12	16	20	24	28	32	36	40
5	10	15	20	25	30	35	40	45	50
6	12	18	24	30	36	42	48	54	60
7	14	21	28	35	42	49	56	63	70
8	16	24	32	40	48	56	64	72	80
9	18	27	36	45	54	63	72	81	90
10	20	30	40	50	60	70	80	90	100

## 14.7 Special Control Characters

Control characters are invisible on the screen. They have special purposes usually to do with cursor movement. They are written into an ordinary string by typing a backslash character `\` followed by some other character. These characters are listed below.

<code>\b</code>	backspace BS
<code>\f</code>	form feed FF (also clear screen)
<code>\n</code>	new line NL (like pressing return)
<code>\r</code>	carriage return CR (cursor to start of line)
<code>\t</code>	horizontal tab HT
<code>\v</code>	vertical tab
<code>\"</code>	double quote
<code>\'</code>	single quote character <code>'</code>
<code>\\</code>	backslash character <code>'\'</code>
<code>\ddd</code>	character <i>ddd</i> where <i>ddd</i> is an ASCII code given in octal or base 8, See <a href="#">[Character Conversion Table]</a> , page <a href="#">(undefined)</a> .
<code>\xddd</code>	character <i>ddd</i> where <i>ddd</i> is an ASCII code given in hexadecimal or base 16, See <a href="#">[Character Conversion Table]</a> , page <a href="#">(undefined)</a> .

## 14.8 Questions

1. Write a program which simply prints out: '6.23e+00'
2. Investigate what happens when you type the wrong conversion specifier in a program. e.g. try printing an integer with '%f' or a floating point number with '%c'. This is bound to go wrong – but how will it go wrong?
3. What is wrong with the following statements?
  1. `printf (x);`
  2. `printf ("%d");`
  3. `printf ();`
  4. `printf ("Number = %d");`

Hint: if you don't know, try them in a program!

## 14.9 scanf

`scanf` is the input function which gets formatted input from the file `stdin` (the keyboard). This is a very versatile function but it is also very easy to go wrong with. In fact it is probably the most difficult to understand of all the C standard library functions.

Remember that C treats its keyboard input as a file. This makes quite a difference to the way that `scanf` works. The actual mechanics of `scanf` are very similar to those of `printf` in reverse

```
scanf ("string...",pointers);
```

with one important exception: namely that it is not variables which are listed after the control string, but pointers to variables. Here are some valid uses of `scanf`:

```
int i;
char ch;
float x;

scanf ("%d %c %f", &i, &ch, &x);
```

Notice the '&' characters which make the arguments pointers. Also notice the conversion specifiers which tell `scanf` what types of data it is going to read. The other possibility is that a program might already have pointers to a particular set of variables in that case the '&' is not needed. For instance:

```
function (i,ch,x)

int *i;
char *ch;
float *x;

{
```

```
scanf ("%d %c %f", i, ch, x);
}
```

In this case it would actually be wrong to write the ampersand ‘&’ symbol.

## 14.10 Conversion characters

The conversion characters for `scanf` are not identical to those for `printf` and it is much more important to be precise and totally correct with these than it is with `printf`.

<code>d</code>	denary integer (int or long int)
<code>ld</code>	long decimal integer
<code>x</code>	hexadecimal integer
<code>o</code>	octal integer
<code>h</code>	short integer
<code>f</code>	float type
<code>lf</code>	long float or double
<code>e</code>	float type
<code>le</code>	double
<code>c</code>	single character
<code>s</code>	character string

The difference between short integer and long integer can make or break a program. If it is found that a program’s input seems to be behaving strangely, check these carefully. (See the section on Errors and Debugging for more about this.)

## 14.11 How does scanf see the input?

When `scanf` is called in a program it checks to see what is in the input file, that is, it checks to see what the user has typed in at the keyboard. Keyboard input is usually buffered. This means that the characters are held in a kind of waiting bay in the memory until they are read. The buffer can be thought of as a part of the input file `stdin`, holding some characters which can be scanned though. If the buffer has some characters in it, `scanf` will start to look through these; if not, it will wait for some characters to be put into the buffer.

There is an important point here: although `scanf` will start scanning through characters as soon as they are in the buffer, the operating system often sees to it that `scanf` doesn’t get to know about any of the characters until the user has pressed the *RETURN* or *ENTER* key on the computer or

terminal. If the buffer is empty `scanf` will wait for some characters to be put into it.

To understand how `scanf` works, it is useful to think of the input as coming in ‘lines’. A line is a bunch of characters ending in a newline character ‘`\n`’. This can be represented by a box like the one below:

```

-----
| some...chars.738/ .                |'\n'|
-----

```

As far as `scanf` is concerned, the input is entirely made out of a stream of characters. If the programmer says that an integer is to be expected by using the ‘`%d`’ conversion specifier then `scanf` will try to make sense of the characters as an integer. In other words, it will look for some characters which make up a valid integer, such as a group of numbers all between 0 and 9. If the user says that floating point type is expected then it will look for a number which may or may not have a decimal point in it. If the user just wants a character then any character will do!

## 14.12 First account of `scanf`

Consider the example which was give above.

```

int i;
char ch;
float x;

scanf ("%d %c %f", &i, &ch, &x);

```

Here is a simplified, ideal view of what happens. `scanf` looks at the control string and finds that the first conversion specifier is ‘`%d`’ which means an integer. It then tries to find some characters which fit the description of an integer in the input file. It skips over any white space characters (spaces, newlines) which do not constitute a valid integer until it matches one. Once it has matched the integer and placed its value in the variable `i` it carries on and looks at the next conversion specifier ‘`%c`’ which means a character. It takes the next character and places it in `ch`. Finally it looks at the last conversion specifier ‘`%f`’ which means a floating point number and finds some characters which fit the description of a floating point number. It passes the value onto the variable `x` and then quits.

This brief account of `scanf` does not tell the whole story by a long way. It assumes that all the characters were successfully found and that everything went smoothly: something which seldom happens in practice!

### 14.13 The dangerous function

What happens if `scanf` doesn't find an integer or a float type? The answer is that it will quit at the first item it fails to match, leaving that character and the rest of the input line still to be read in the file. At the first character it meets which does not fit in with the conversion string's interpretation `scanf` aborts and control passes to the next C statement. This is why `scanf` is a 'dangerous' function: because it can quit in the middle of a task and leave a lot of surplus data around in the input file. These surplus data simply wait in the input file until the next `scanf` is brought into operation, where they can also cause it to quit. It is not safe, therefore, to use `scanf` by itself: without some check that it is working successfully.

`scanf` is also dangerous for the opposite reason: what happens if `scanf` doesn't use up all the characters in the input line before it satisfies its needs? Again the answer is that it quits and leaves the extra characters in the input file `stdin` for the next `scanf` to read, exactly where it left off. So if the program was meant to read data from the input and couldn't, it leaves a mess for something else to trip over. `scanf` can get out of step with its input if the user types something even slightly out of line. It should be used with caution...

### 14.14 Keeping scanf under control

`scanf` may be dangerous for sloppy programs which do not check their input carefully, but it is easily tamed by using it as just a part of a more sophisticated input routine and sometimes even more simply with the aid of a very short function which can be incorporated into any program:

```
skipgarb()      /* skip garbage corrupting scanf */

{
  while (getchar() != '\n')
    {
    }
}
```

The action of this function is simply to skip to the end of the input line so that there are no characters left in the input. It cannot stop `scanf` from getting out of step before the end of a line because no function can stop the user from typing in nonsense! So to get a single integer, for instance, a program could try:

```
int i;

scanf("%d",&i);
skipgarb();
```

The programmer must police user-garbage personally by using a loop to the effect of:

```

while (inputisnonsense)

{
printf ("Get your act together out there!!\n");
scanf (..)
skipgarb();
}

```

It is usually as well to use `skipgarb()` every time.

## 14.15 Examples

Here are some example programs with example runs to show how `scanf` either works or fails.

```

/*****
/* Example 1
/*****

#include <stdio.h>

main ()

{ int i = 0;
  char ch = '*';
  float x = 0;

  scanf ("%d %c %f", &i, &ch, &x);

  printf ("%d %c %f\n", i, ch, x);
}

```

This program just waits for a line from the user and prints out what it makes of that line. Things to notice about these examples are the way in



which `scanf` 'misunderstands' what the user has typed in and also the values which the variables had before the `scanf` function.

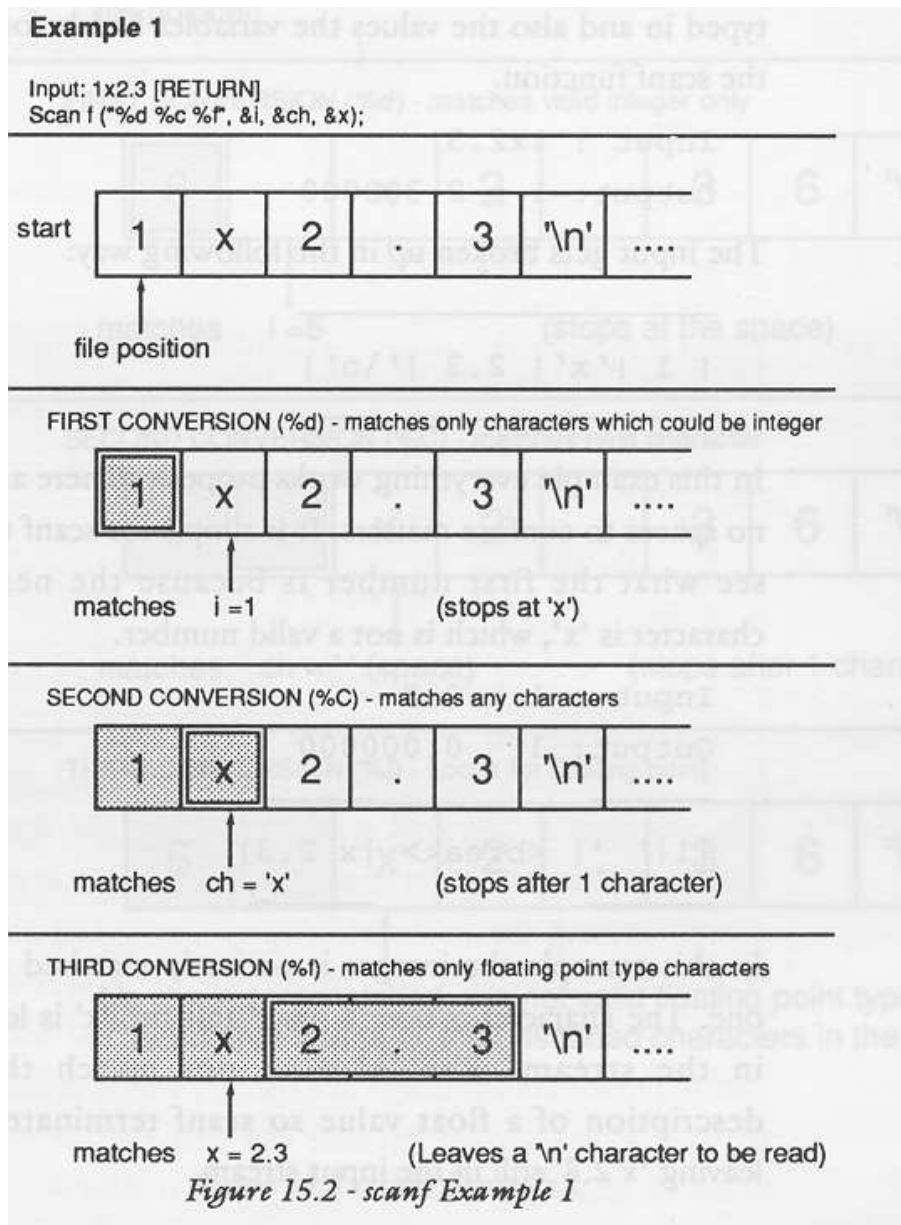

Input : 1x2.3  
Output: 1 x 2.300000

The input gets broken up in the following way:

```
-----
| 1 |'x'| 2.3 |'\n'|
-----
```

In this example everything works properly. There are no spaces to confuse matters. It is simple for `scanf` to see what the first number is because the next character is `x` which is not a valid number.

```
Input : 1 x 2.3
Output: 1 0.000000
```

```
-----
|1|' '| <break> |x 2.3|
-----
```

In this example the integer is correctly matched as 1. The character is now a space and the `x` is left in the stream. The `x` does not match the description of a float value so `scanf` terminates, leaving `x 2.3` still in the input stream.

```
Input : .
Output: 0 * 0.000000
```

```
---
|'. '| <break>
---
```

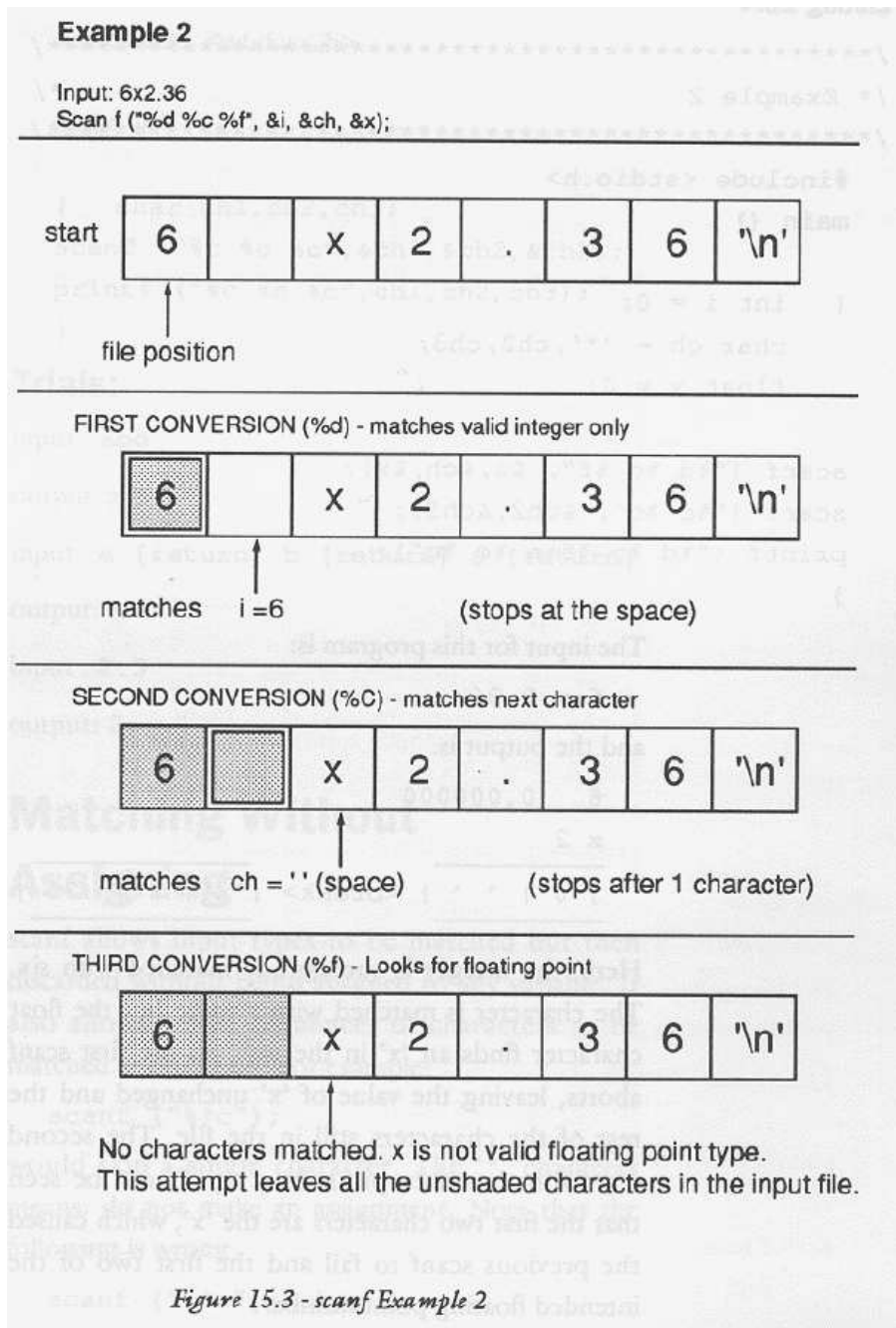

A single full-stop (period). `scanf` quits straight away because it looks for an integer. It leaves the whole input line (which is just the period '.') in the input stream.

```

/*****
/* Example 2
/*****

#include <stdio.h>

main ()

{ int i = 0;
  char ch = '*',ch2,ch3;
  float x = 0;

  scanf ("%d %c %f", &i,&ch,&x);
  scanf ("%c %c", &ch2,&ch3);
  printf ("%d %c %f\n %c %c");
}

```

The input for this program is:

```
6 x2.36
```

and the output is:

```

6 0.000000
x 2
-----
| 6 | ' ' | <break> | 'x'|'2'| .36 |
-----

```

Here the integer is successfully matched with 6. The character is matched with a space but the float character finds an x in the way, so the first `scanf` aborts leaving the value of `x` unchanged and the rest of the characters still in the file. The second `scanf` function then picks these up. It can be seen that the first two characters are the x which caused the previous `scanf` to fail and the first 2 of the intended floating point number.

```

/*****
/* Example 3
/*****

#include <stdio.h>

main()

{ char ch1,ch2,ch3;

  scanf ("%c %c %c",&ch1,&ch2,&ch3);

```

```
printf ("%c %c %c", ch1, ch2, ch3);
}
```

Trials:

```
input : abc
output: a b c
```

```
input : a [return]
       b [return]
       c [return]
output: a b c
```

```
input : 2.3
output: 2 . 3
```

## 14.16 Matching without assigning

`scanf` allows input types to be matched but then discarded without being assigned to any variable. It also allows whole sequences of characters to be matched and skipped. For example:

```
scanf ("%*c");
```

would skip a single character. The ‘\*’ character means do not make an assignment. Note carefully that the following is *wrong*:

```
scanf ("%*c", &ch);
```

A pointer should not be given for a dummy conversion character. In this simple case above it probably does not matter, but in a string with several things to be matched, it would make the conversion characters out of step with the variables, since `scanf` does not return a value from a dummy conversion character. It might seem as though there would be no sense in writing:

```
scanf ("%*s %f %c", &x, &ch);
```

because the whole input file is one long string after all, but this is not true because, as far as `scanf` is concerned a string is terminated by any white space character, so the float type `x` and the character `ch` would receive values provided there were a space or newline character after any string.

If any non-conversion characters are typed into the string `scanf` will match and skip over them in the input. For example:

```
scanf (" Number = %d", &i);
```

If the input were: *Number = 256*, `scanf` would skip over the *Number =*. As usual, if the string cannot be matched, `scanf` will abort, leaving the remaining characters in the input stream.

```

/*****
/* Example 4
*****/

#include <stdio.h>

main()

{ float x = 0;
  int i = 0;
  char ch = '*';

  scanf("Skipthis! %f %d %c",&i);

  printf("%f %d %c",x,i,ch);

}

Input : Skipthis! 23
Output: 0.000000 23 *

Input : 26
Output: 0.000000 0 *

```

In this last case `scanf` aborted before matching anything.

## 14.17 Formal Definition of `scanf`

The general form of the `scanf` function is:

```
n = scanf ("string...", pointers);
```

The value `n` returned is the number of items matched or the end of file character `EOF`, or `NULL` if the first item did not match. This value is often discarded. The control string contains a number of conversion specifiers with the following general form:

```
%[*][n]X
```

- [\*] the optional assignment suppression character.
- [n] this is a number giving the maximum field width to be accepted by `scanf` for a particular item. That is, the maximum number of

characters which are to be thought of as being part of one the current variable value.

X is one of the characters listed above.

Any white space characters in the `scanf` string are ignored. Any other characters are matched. The pointers must be pointers to variables of the correct type and they must match the conversion specifiers in the order in which they are written.

There are two variations on the conversion specifiers for strings, though it is very likely that many compilers will not support this. Both of the following imply strings:

`%[set of characters]`  
a string made up of the given characters only.

`%[^set of characters]`  
a string which is delimited by the set of characters given.

For example, to read the rest of a line of text, up to but not including the end of line, into a string array one would write:

```
scanf("%[^\n]", stringarray);
```

## 14.18 Summary of points about scanf

- `scanf` works across input lines as though it were dealing with a file. Usually the user types in a line and hits return. The whole line is then thought of as being part of the input file pointer `stdin`.
- If `scanf` finds the end of a line early it will try to read past it until all its needs are satisfied.
- If `scanf` fails at any stage to match the correct type of string at the correct time, it will quit leaving the remaining input still in the file.
- If an element is not matched, no value will be assigned to the corresponding variable.
- White space characters are ignored for all conversion characters except `%c`. Only a `%c` type can contain a white space character.
- White space characters in

## 14.19 Questions

1. What is a white space character?
2. Write a program which fetches two integers from the user and multiplies them together. Print out the answer. Try to make the input as safe as possible.
3. Write a program which just echoes all the input to the output.

4. Write a program which strips spaces out of the input and replaces them with a single newline character.
5. `scanf` always takes pointer arguments. True or false?

## 14.20 Low Level Input/Output

### 14.20.1 `getchar` and `putchar`

`scanf()` and `printf()` are relatively high level functions: this means that they are versatile and do a lot of hidden work for the user. C also provides some functions for dealing with input and output at a lower level: character by character. These functions are called `getchar()` and `putchar()` but, in fact, they might not be functions: they could be macros instead, See Chapter 12 [Preprocessor], page 71.

high level:	<code>printf()</code>		<code>scanf()</code>
	/		\
low level:	<code>putchar()</code>		<code>getchar()</code>

`getchar` gets a single character from the input file `stdin`; `putchar` writes a single character to the output file `stdout`. `getchar` returns a character type: the next character on the input file. For example:

```
char ch;

ch = getchar();
```

This places the next character, what ever it might be, into the variable `ch`. Notice that no conversion to different data types can be performed by `getchar()` because it deals with single characters only. It is a low level function and does not 'know' anything about data types other than characters.

`getchar` was used in the function `skipgarb()` to tame the `scanf()` function. This function was written in a very compact way. Another way of writing it would be as below:

```
skipgarb ()    /* skip garbage corrupting scanf */

{ char ch;

  ch = getchar();

  while (ch != '\n')
  {
    ch = getchar();
```



```
    }
}
```

The '`!=`' symbol means "is not equal to" and the while statement is a loop. This function keeps on `getchar`-ing until it finds the newline character and then it quits. This function has many uses. One of these is to copy immediate keypress statements of languages like BASIC, where a program responds to keys as they are pressed without having to wait for return to be pressed. Without special library functions to give this kind of input (which are not universal) it is only possible to do this with the return key itself. For example:

```
printf("Press RETURN to continue\n");

skipgarb();
```

`skipgarb()` does not receive any input until the user presses *RETURN*, and then it simply skips over it in one go! The effect is that it waits for *RETURN* to be pressed.

`putchar()` writes a character type and also returns a character type. For example:

```
char ch = '*';

putchar (ch);
ch = putchar (ch);
```

These two alternatives have the same effect. The value returned by `putchar()` is the character which was written to the output. In other words it just hands the same value back again. This can simply be discarded, as in the first line. `putchar()` is not much use without loops to repeat it over and over again.

An important point to remember is that `putchar()` and `getchar()` could well be implemented as macros, rather than functions. This means that it might not be possible to use functions as parameters inside them:

```
putchar( function() );
```

This depends entirely upon the compiler, but it is something to watch out for.

### 14.20.2 gets and puts

Two functions which are similar to `putchar()` and `getchar()` are `puts()` and `gets()` which mean `putstring` and `getstring` respectively. Their purpose is either to read a whole string from the input file `stdin` or write a whole string to the output `stdout`. Strings are groups or arrays of characters. For instance:

```
char *string[length];
```

```
string = gets(string);  
puts(string);
```

More information about these is given later, See [\[Strings\]](#), page [\[undefined\]](#).

## 14.21 Questions

1. Is the following statement possible? (It could depend upon your compiler: try it!)

```
putchar(getchar());
```

What might this do? (Hint: re-read the chapter about the pre-processor.)

2. Re write the statement in question 1, assuming that `putchar()` and `getchar()` are macros.

## 15 Assignments, Expressions and Operators

*Thinking in C. Working things out.*

An **operator** is something which takes one or more values and does something useful with those values to produce a result. It operates on them. The terminology of operators is the following:

- operator*    Something which operates on something.
- operand*    Each thing which is operated upon by an operator is called an operand.
- operation*   The action which was carried out upon the operands by the operator!

There are lots of operators in C. Some of them may already be familiar:

+ - \* / = & ==

Most operators can be thought of as belonging to one of three groups, divided up arbitrarily according to what they do with their operands. These rough groupings are thought of as follows:

- Operators which produce new values from old ones. They make a result from their operands. e.g. +, the addition operator takes two numbers or two variables or a number and a variable and adds them together to give a new number.
- Operators which make comparisons. e.g. less than, equal to, greater than...
- Operators which produce new variable types: like the cast operator.

The majority of operators fall into the first group. In fact the second group is a subset of the first, in which the result of the operation is a boolean value of either **true** or **false**.

C has no less than thirty nine different operators. This is more than, say, Pascal and BASIC put together! The operators serve a variety of purposes and they can be used very freely. The object of this chapter is to explain the basics of operators in C. The more abstruse operators are looked at in another chapter.

### 15.1 Expressions and values

The most common operators in any language are basic arithmetic operators. In C these are the following:

+            plus (unary)

-	minus (force value to be negative)
+	addition
-	subtraction
*	multiplication
/	floating point division
/	integer division "div"
%	integer remainder "mod"

These operators would not be useful without a partner operator which could attach the values which they produce to variables. Perhaps the most important operator then is the assignment operator:

`=` assignment operator

This has been used extensively up to now. For example:

```
double x,y;

x = 2.356;
y = x;

x = x + 2 + 3/5;
```

The assignment operator takes the value of whatever is on the right hand side of the '=' symbol and puts it into the variable on the left hand side. As usual there is some standard jargon for this, which is useful to know because compilers tend to use this when handing out error messages. The assignment operator can be summarized in the following way:

*lvalue* = *expression*;

This statement says no more than what has been said about assignments already: namely that it takes something on the right hand side and attaches it to whatever is on the left hand side of the '=' symbol. An *expression* is simply the name for any string of operators, variables and numbers. All of the following could be called expressions:

```
1 + 2 + 3

a + somefunction()

32 * x/3

i % 4

x
```

```

1
(22 + 4*(function() + 2))

function () /* provided it returns a sensible value */

```

*Lvalues* on the other hand are simply names for memory locations: in other words variable names, or identifiers. The name comes from ‘left values’ meaning anything which can legally be written on the left hand side of an assignment.

## 15.2 Example

```

/*****
/*
/* Operators Demo # 1
/*
/*
*****/

#include <stdio.h>

/*****

main ()

{ int i;

printf ("Arithmetic Operators\n\n");

i = 6;
printf ("i = 6, -i is : %d\n", -i);

printf ("int 1 + 2 = %d\n", 1 + 2);
printf ("int 5 - 1 = %d\n", 5 - 1);
printf ("int 5 * 2 = %d\n", 5 * 2);

printf ("\n9 div 4 = 2 remainder 1:\n");
printf ("int 9 / 4 = %d\n", 9 / 4);
printf ("int 9 % 4 = %d\n", 9 % 4);

printf ("double 9 / 4 = %f\n", 9.0 / 4.0);
}

```

## 15.3 Output

```

Arithmetic Operators

i = 6, -i is : -6

```

```

int 1 + 2 = 3
int 5 - 1 = 4
int 5 * 2 = 10

9 div 4 = 2 remainder 1:
int 9 / 4 = 2
int 9 % 4 = 1
double 9 / 4 = 2.250000

```

## 15.4 Parentheses and Priority

Parentheses are classed as operators by the compiler, although their position is a bit unclear. They have a value in the sense that they assume the value of whatever expression is inside them. Parentheses are used for forcing a priority over operators. If an expression is written out in an ambiguous way, such as:

$$a + b / 4 * 2$$

it is not clear what is meant by this. It could be interpreted in several ways:

$$((a + b) / 4) * 2$$

or

$$(a + b) / (4 * 2)$$

or

$$a + (b/4) * 2$$

and so on. By using parentheses, any doubt about what the expression means is removed. Parentheses are said to have a higher priority than + \* or / because they are evaluated as "sealed capsules" before other operators can act on them. Putting parentheses in may remove the ambiguity of expressions, but it does not alter the fact that

$$a + b / 4 * 2$$

is ambiguous. What will happen in this case? The answer is that the C compiler has a convention about the way in which expressions are evaluated: it is called operator precedence. The convention is that some operators are stronger than others and that the stronger ones will always be evaluated first. Otherwise, expressions like the one above are evaluated from left to right: so an expression will be dealt with from left to right unless a strong operator overrides this rule. Use parentheses to be sure. A table of all operators and their priorities is given in the reference section.

## 15.5 Unary Operator Precedence

Unary operators are operators which have only a single operand: that is, they operate on only one object. For instance:

```
++ -- + - &
```

The precedence of unary operators is from right to left so an expression like:

```
*ptr++;
```

would do ++ before \*.

## 15.6 Special Assignment Operators ++ and --

C has some special operators which cut down on the amount of typing involved in a program. This is a subject in which it becomes important to think in C and not in other languages. The simplest of these perhaps are the increment and decrement operators:

++            increment: add one to

--            decrement: subtract one from

These attach to any variable of integer or floating point type. (character types too, with care.) They are used to simply add or subtract 1 from a variable. Normally, in other languages, this is accomplished by writing:

```
variable = variable + 1;
```

In C this would also be quite valid, but there is a much better way of doing this:

```
variable++; or
++variable;
```

would do the same thing more neatly. Similarly:

```
variable = variable - 1;
```

is equivalent to:

```
variable--;
```

or

```
--variable;
```

Notice particularly that these two operators can be placed in front or after the name of the variable. In some cases the two are identical, but in the

more advanced uses of C operators, which appear later in this book, there is a subtle difference between the two.

## 15.7 More Special Assignments

Here are some of the nicest operators in C. Like ++ and -- these are short ways of writing longer expressions. Consider the statement:

```
variable = variable + 23;
```

In C this would be a long winded way of adding 23 to `variable`. It could be done more simply using the general increment operator: +=

```
variable += 23;
```

This performs exactly the same operation. Similarly one could write:

```
variable1 = variable1 + variable2;
```

as

```
variable1 += variable2;
```

and so on. There is a handful of these

```
<operation>=
```

operators: one for each of the major operations which can be performed. There is, naturally, one for subtraction too:

```
variable = variable - 42;
```

can be written:

```
variable -= 42;
```

More surprisingly, perhaps, the multiplicative assignment:

```
variable = variable * 2;
```

may be written:

```
variable *= 2;
```

and so on. The main arithmetic operators all follow this pattern:

+=           add assign

-=           subtract assign



\*= multiply assign  
 /= divide (double) and (int) types  
 %= remainder (int) type only.

and there are more exotic kinds, used for bit operations or machine level operations, which will be ignored at this stage:

```

>>=
<<=
^=
|=
&=
  
```

## 15.8 Example Listing

```

/*****
/*
/* Operators Demo # 2
/*
*****/

#include <stdio.h>

/*****

main ()

{ int i;

printf ("Assignment Operators\n\n");

i = 10; /* Assignment */
printf("i = 10 : %d\n",i);

i++; /* i = i + 1 */
printf ("i++ : %d\n",i);

i += 5; /* i = i + 5 */
printf ("i += 5 : %d\n",i);

i--; /* i = i - 1 */
printf ("i-- : %d\n",i);

i -= 2; /* i = i - 2 */
printf ("i -= 2 : %d\n",i);

i *= 5; /* i = i * 5 */
printf ("i *= 5 :%d\n",i);
  
```

```

i /= 2;                               /* i = i / 2 */
printf ("i /= 2 : %d\n",i);

i %= 3;                               /* i = i % 3 */
printf ("i %= 3 : %d\n",i);
}

```

## 15.9 Output

### Assignment Operators

```

i = 10 : 10
i++ : 11
i += 5 : 16
i-- : 15
i -= 2 : 13
i *= 5 :65
i /= 2 : 32
i %= 3 : 2

```

## 15.10 The Cast Operator

The cast operator is an operator which forces a particular type mould or type cast onto a value, hence the name. For instance a character type variable could be forced to fit into an integer type box by the statement:

```

char ch;
int i;

i = (int) ch;

```

This operator was introduced earlier, See Chapter 9 [Variables], page 37. It will always produce some value, whatever the conversion: however remotely improbable it might seem. For instance it is quite possible to convert a character into a floating point number: the result will be a floating point representation of its ASCII code!

## 15.11 Expressions and Types

There is a rule in C that all arithmetic and mathematical operations must be carried out with `long` variables: that is, the types

```

double
long float

int
long int

```

If the programmer tries to use other types like `short` or `float` in a mathematical expression they will be cast into long types automatically by the compiler. This can cause confusion because the compiler will spot an error in the following statement:

```
short i, j = 2;

i = j * 2 + 1;
```

A compiler will claim that there is a type mismatch between `i` and the expression on the right hand side of the assignment. The compiler is perfectly correct of course, even though it appears to be wrong. The subtlety is that arithmetic cannot be done in short type variables, so that the expression is automatically converted into `long` type or `int` type. So the right hand side is `int` type and the left hand side is `short` type: hence there is indeed a type mismatch. The programmer can get around this by using the cast operator to write:

```
short i, j = 2;

i = (short) j * 2 + 1;
```

A similar thing would happen with `float`:

```
float x, y = 2.3;

x = y * 2.5;
```

would also be incorrect for the same reasons as above.

Comparisons and Logic

## 15.12 Comparisons and Logic

Six operators in C are for making logical comparisons. The relevance of these operators will quickly become clear in the next chapter, which is about decisions and comparisons. The six operators which compare values are:

<code>==</code>	is equal to
<code>!=</code>	is not equal to
<code>&gt;</code>	is greater than
<code>&lt;</code>	is less than
<code>&gt;=</code>	is greater than or equal to
<code>&lt;=</code>	is less than or equal to

These operators belong to the second group according to the scheme above but they do actually result in values so that they could be thought of as being

a part of the first group of operators too. The values which they produce are called true and false. As words, "true" and "false" are not defined normally in C, but it is easy to define them as macros and they may well be defined in a library file:

```
#define TRUE 1
#define FALSE 0
```

Falsity is assumed to have the value zero in C and truth is represented by any non-zero value. These comparison operators are used for making decisions, but they are themselves operators and expressions can be built up with them.

```
1 == 1
```

has the value "true" (which could be anything except zero). The statement:

```
int i;
i = (1 == 2);
```

would be false, so `i` would be false. In other words, `i` would be zero.

Comparisons are often made in pairs or even in groups and linked together with words like OR and AND. For instance, some test might want to find out whether:

*(A is greater than B) AND (A is greater than C)*

C does not have words for these operations but gives symbols instead. The logical operators, as they are called, are as follows:

```
&&      logical AND
||      logical OR inclusive
!       logical NOT
```

The statement which was written in words above could be translated as:

`(A > B) && (A > C)`

The statement:

`(A is greater than B) AND (A is not greater than C)`

translates to:

`(A > B) && !(A > C)`

Shakespeare might have been disappointed to learn that, whatever the value of a variable `tobe` the result of

```
thequestion = tobe || !tobe
```

must always be true. The NOT operator always creates the logical opposite: `!true` is false and `!false` is true. On or the other of these must be true. `thequestion` is therefore always true. Fortunately this is not a matter of life or death!

### 15.13 Summary of Operators and Precedence

The highest priority operators are listed first.

<i>Operator</i>	<i>Operation</i>	<i>Evaluated.</i>
()	parentheses	left to right
[]	square brackets	left to right
++	increment	right to left
--	decrement	right to left
(type)	cast operator	right to left
*	the contents of	right to left
&	the address of	right to left
-	unary minus	right to left
~	one's complement	right to left
!	logical NOT	right to left
*	multiply	left to right
/	divide	left to right
%	remainder (MOD)	left to right
+	add	left to right
-	subtract	left to right
>>	shift right	left to right
<<	shift left	left to right
>	is greater than	left to right
>=	greater than or equal to	left to right
<=	less than or equal to	left to right
<	less than	left to right
==	is equal to	left to right
!=	is not equal to	left to right
&	bitwise AND	left to right
^	bitwise exclusive OR	left to right
	bitwise inclusive OR	left to right
&&	logical AND	left to right
	logical OR	left to right
=	assign	right to left

+=	add assign	right to left
-=	subtract assign	right to left
*=	multiply assign	right to left
/=	divide assign	right to left
%=	remainder assign	right to left
>>=	right shift assign	right to left
<<=	left shift assign	right to left
&=	AND assign	right to left
^=	exclusive OR assign	right to left
=	inclusive OR assign	right to left

## 15.14 Questions

1. What is an operand?
2. Write a statement which prints out the remainder of 5 divided by 2.
3. Write a short statement which assigns the remainder of 5 divided by 2 to a variable called "rem".
4. Write a statement which subtracts -5 from 10.
5. Write in C: if 1 is not equal to 23, print out "Thank goodness for mathematics!"

## 16 Decisions

*Testing and Branching. Making conditions.*

Suppose that a fictional traveller, some character in a book like this one, came to the end of a straight, unfinished road and waited there for the author to decide where the road would lead. The author might decide a number of things about this road and its traveller:

- The road will carry on in a straight line. If the traveller is thirsty he will stop for a drink before continuing.
- The road will fork and the traveller will have to decide whether to take the left branch or the right branch.
- The road might have a crossroads or a meeting point where many roads come together. Again the traveller has to decide which way to go.

We are often faced with this dilemma: a situation in which a decision has to be made. Up to now the simple example programs in this book have not had any choice about the way in which they progressed. They have all followed narrow paths without any choice about which way they were going. This is a very limited way of expressing ideas though: the ability to make decisions and to choose different options is very useful in programming. For instance, one might want to implement the following ideas in different programs:

- If the user hits the jackpot, write some message to say so. "You've won the game!"
- If a bank balance is positive then print C for credit otherwise print D for debit.
- If the user has typed in one of five things then do something special for each special case, otherwise do something else.

These choices are actually just the same choices that the traveller had to make on his undecided path, thinly disguised. In the first case there is a simple choice: a do or don't choice. The second case gives two choices: do thing 1 or thing 2. The final choice has several possibilities.

C offers four ways of making decisions like the ones above. They are listed here below. The method which is numbered 2b was encountered in connection with the C preprocessor; its purpose is very similar to 2a.

```
1:   if (something_is_true)
      {
      /* do something */
      }

2a:  if (something_is_true)
      {
      /* do one thing */
```

```
    }
else
  {
    /* do something else */
  }

2b:  ? (something_is_true) :

      /* do one thing */
      :

      /* do something else */

3:   switch (choice)
      {
        case first_possibility : /* do something */
        case second_possibility : /* do something */
        .....
      }
```

## 16.1 if

The first form of the `if` statement is an all or nothing choice. `if` some condition is satisfied, do what is in the braces, otherwise just skip what is in the braces. Formally, this is written:

```
if (condition) statement;
```

or

```
if (condition)
{
  compound statement
}
```



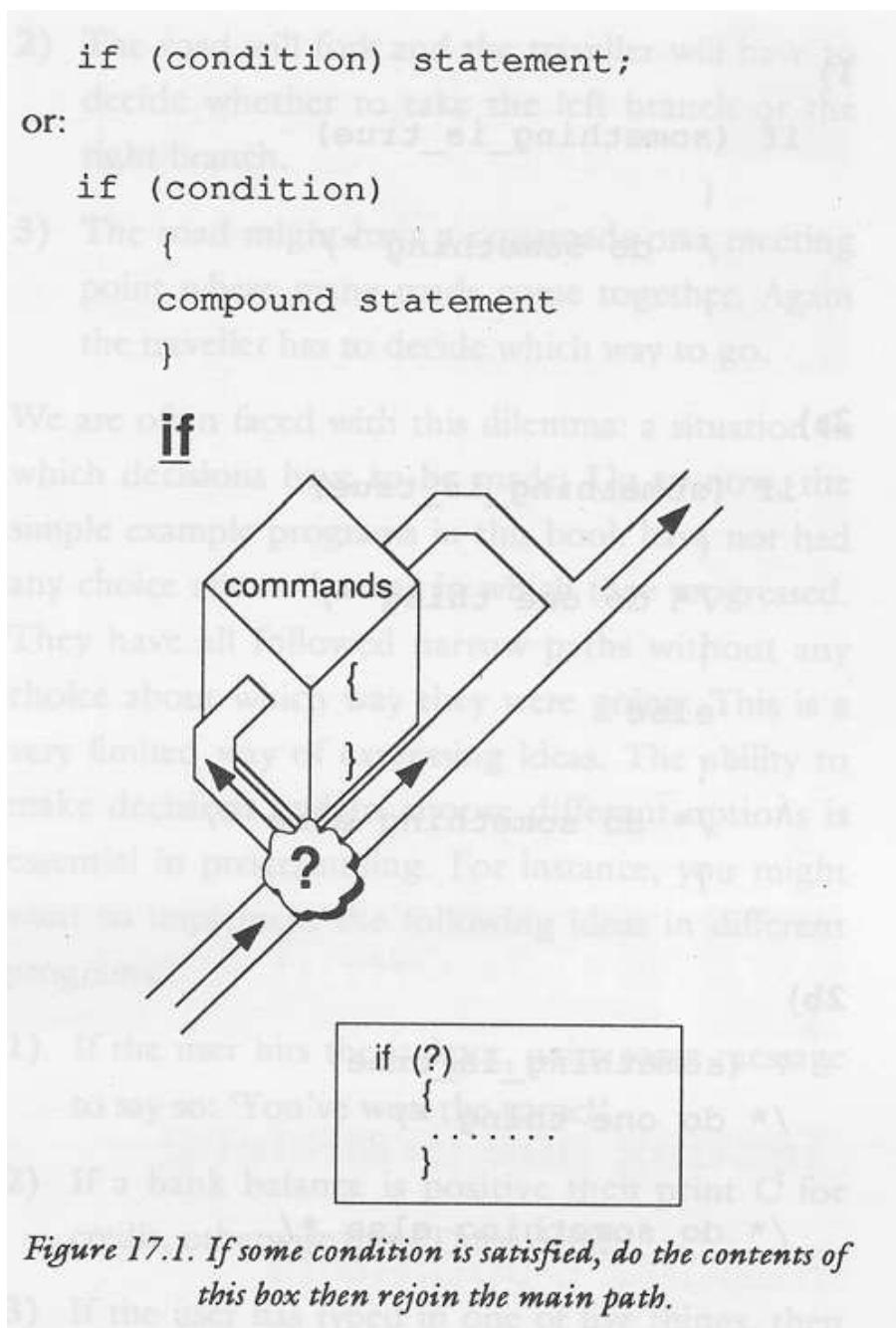

Notice that, as well as a single statement, a whole block of statements can be written under the if statement. In fact, there is an unwritten rule of thumb in C that wherever a single statement will do, a *compound statement* will do instead. A compound statement is a block of single statements enclosed by curly braces.

A condition is usually some kind of comparison, like the ones discussed in the previous chapter. It must have a value which is either true or false (1 or 0) and it must be enclosed by the parentheses ( and ). If the condition has the value 'true' then the statement or compound statement following the condition will be carried out, otherwise it will be ignored. Some of the following examples help to show this:

```
int i;

printf ("Type in an integer");

scanf ("%ld",&i);

if (i == 0)
{
    printf ("The number was zero");
}

if (i > 0)
{
    printf ("The number was positive");
}

if (i < 0)
{
    printf ("The number was negative");
}
```

The same code could be written more briefly, but perhaps less consistently in the following way:

```
int i;

printf ("Type in an integer");

scanf ("%ld",&i);

if (i == 0) printf ("The number was zero");
if (i > 0) printf ("The number was positive");
if (i < 0) printf ("The number was negative");
```

The preference in this book is to include the block braces, even when they are not strictly required. This does no harm. It is no more or less efficient, but very often you will find that some extra statements have to go into those braces, so it is as well to include them from the start. It also has the appeal

that it makes `if` statements look the same as all other block statements and it makes them stand out clearly in the program text. This rule of thumb is only dropped in very simple examples like:

```
if (i == 0) i++;
```

The `if` statement alone allows only a very limited kind of decision: it makes do or don't decisions; it could not decide for the traveller whether to take the left fork or the right fork of his road, for instance, it could only tell him whether to get up and go at all. To do much more for programs it needs to be extended. This is the purpose of the `else` statement, described after some example listings..

## 16.2 Example Listings

```
/*
 *
 * If... #1
 *
 */

#include <stdio.h>

#define TRUE 1
#define FALSE 0

/*
 *
 * main ()
 *
 * { int i;
 *
 * if (TRUE)
 * {
 * printf ("This is always printed");
 * }
 *
 * if (FALSE)
 * {
 * printf ("This is never printed");
 * }
 *
 * }
 *
 */

/*
 *
 * If demo #2
 *
 */
```

```

    /* On board car computer. Works out the */
    /* number of kilometers to the litre   */
    /* that the car is doing at present    */

#include <stdio.h>

/*****
/* Level 0                               */
*****/

main ()

{ double fuel,distance;

FindValues (&fuel,&distance);
Report (fuel,distance);
}

/*****
/* Level 1                               */
*****/

FindValues (fuel,distance) /* from car */

    /* These values would be changing in */
    /* a real car, independently of the  */
    /* program.                          */

double *fuel,*distance;

{
/* how much fuel used since last check on values */

printf ("Enter fuel used");
scanf ("%lf",fuel);

/* distance travelled since last check on values */

printf ("Enter distance travelled");
scanf ("%lf",distance);
}

/*****

Report (fuel,distance) /* on dashboard */

double fuel,distance;

{ double kpl;

kpl = distance/fuel;

```

```

printf ("fuel consumption: %2.1lf",kpl);
printf (" kilometers per litre\n");

if (kpl <= 1)
{
printf ("Predict fuel leak or car");
printf (" needs a service\n");
}

if (distance > 500)
{
printf ("Remember to check tyres\n");
}

if (fuel > 30)          /* Tank holds 40 l */
{
printf ("Fuel getting low: %s left\n",40-fuel);
}
}

```

### 16.3 if ... else

The 'if .. else' statement has the form:

```
if (condition) statement1; else statement2;
```

This is most often written in the compound statement form:

```

if (condition)
{
statements
}
else
{
statements
}

```

The 'if..else' statement is a two way branch: it means do one thing or the other. When it is executed, the condition is evaluated and if it has the value 'true' (i.e. not zero) then *statement1* is executed. If the condition is 'false' (or zero) then *statement2* is executed. The 'if..else' construction often saves an unnecessary test from having to be made. For instance:

```

int i;

scanf ("%ld",i);

if (i > 0)
{

```

```
    printf ("That number was positive!");
}
else
{
    printf ("That number was negative or zero!");
}
```

It is not necessary to test whether `i` was negative in the second block because it was implied by the ‘`if..else`’ structure. That is, that block would not have been executed unless `i` were NOT greater than zero. The weary traveller above might make a decision such as:

```
if (rightleg > leftleg)
{
    take_left_branch();
}
else
{
    take_right_branch();
}
```

## 16.4 Nested ifs and logic

Consider the following statements which decide upon the value of some variable `i`. Their purposes are exactly the same.

```
if ((i > 2) && (i < 4))
{
    printf ("i is three");
}
```

or:

```
if (i > 2)
{
    if (i < 4)
    {
        printf ("i is three");
    }
}
```

Both of these test *i* for the same information, but they do it in different ways. The first method might be born out of the following sequence of thought:

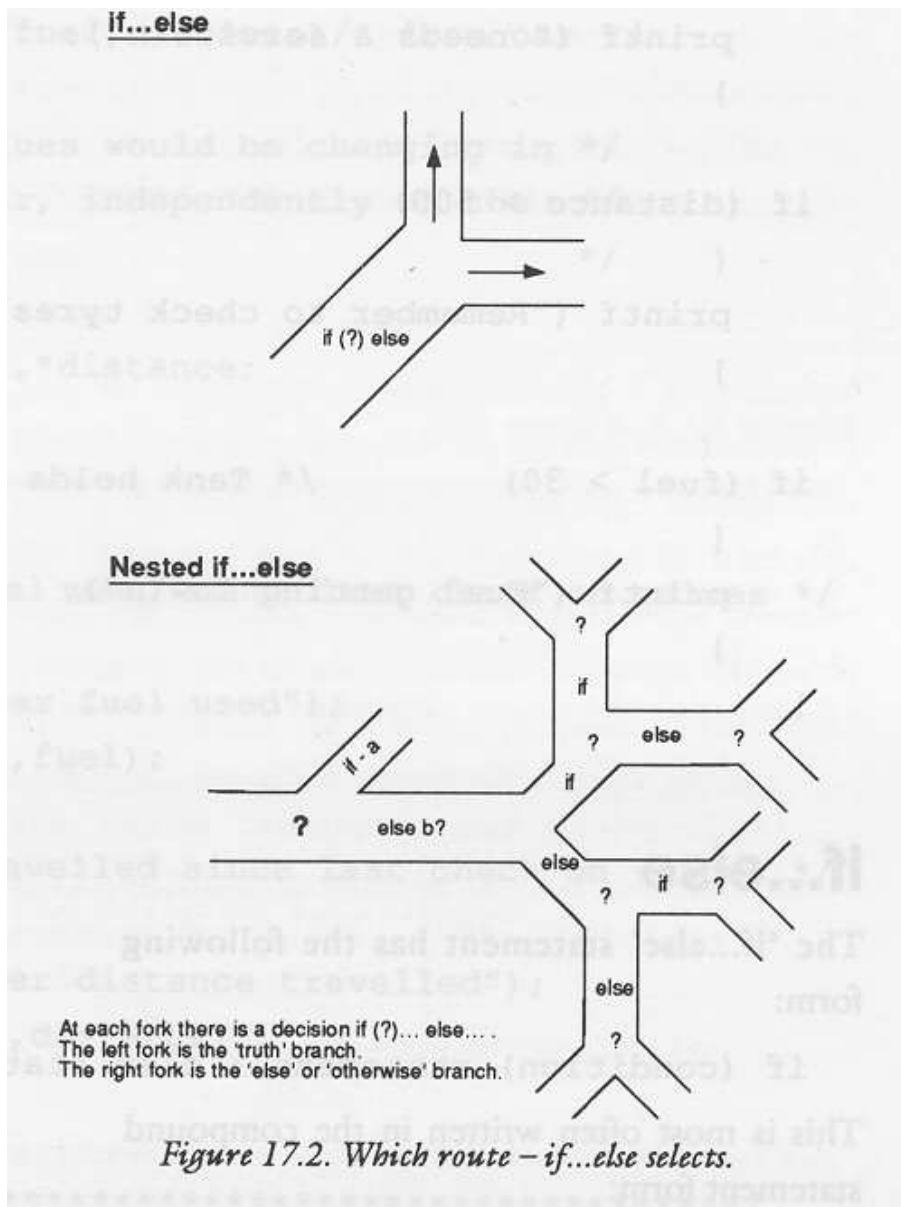

If *i* is greater than 2 and *i* is less than four, both at the same time, then *i* has to be 3.

The second method is more complicated. Think carefully. It says:





```
/******  
main ()  
  
{ int persnum,usernum,balance;  
  
persnum = 7462;  
balance = -12;  
  
printf ("The Plastic Bank Corporation\n");  
printf ("Please enter your personal number :");  
  
usernum = getnumber();  
  
if (usernum == 7462)  
{  
printf ("\nThe current state of your account\n");  
printf ("is %d\n",balance);  
  
if (balance < 0)  
{  
printf ("The account is overdrawn!\n");  
}  
}  
else  
{  
printf ("This is not your account\n");  
}  
  
printf ("Have a splendid day! Thank you.\n");  
}  
  
/******  
getnumber () /* get a number from the user */  
  
{ int num = 0;  
  
scanf ("%d",&num);  
  
if ((num > 9999) || (num <= 0))  
{  
printf ("That is not a valid number\n");  
}  
  
return (num);  
}
```

## 16.6 Stringing together if..else

What is the difference between the following programs? They both interpret some imaginary exam result in the same way. They both look identical when compiled and run. Why then are they different?

```

/*****
/* Program 1
*****/

#include <stdio.h>

main ()

{ int result;

printf("Type in exam result");
scanf ("%d",&result);

if (result < 10)
{
printf ("That is poor");
}

if (result > 20)
{
printf ("You have passed.");
}

if (result > 70)
{
printf ("You got an A!");
}
}

/* end */

/*****
/* Program 2
*****/

#include <stdio.h>

main ()

{ int result;

printf("Type in exam result");
scanf ("%d",&result);

if (result < 10)
```

```

    {
    printf ("That is poor");
    }

else

    {
    if (result > 20)
    {
    printf ("You have passed.");
    }

    else

        {
        if (result > 70)
        {
        printf ("You got an A!");
        }
        }
    }
}

```

The answer is that the second of these programs can be more efficient. This because it uses the `else` form of the `if` statement which in turn means that few things have to be calculated. Program one makes every single test, because the program meets every `if` statement, one after the other. The second program does not necessarily do this however. The nested `if` statements make sure that the second two tests are only made if the first one failed. Similarly the third test is only performed if the first two failed. So the second program could end up doing a third of the work of the first program, in the best possible case. Nesting decisions like this can be an efficient way of controlling long lists of decisions like those above. Nested loops make a program branch into lots of possible paths, but choosing one path would preclude others.

## 16.7 switch: integers and characters

The `switch` construction is another way of making a program path branch into lots of different limbs. It can be used as a different way of writing a string of '`if .. else`' statements, but it is more versatile than that and it only works for integers and character type values. It works like a kind of multi-way switch. (See the diagram.) The `switch` statement has the following form:

```

switch (int or char expression)
{
    case constant : statement;
                    break;          /* optional */
    ...
}

```

}

It has an expression which is evaluated and a number of constant 'cases' which are to be chosen from, each of which is followed by a statement or compound statement. An extra statement called **break** can also be incorporated into the block at any point. **break** is a reserved word.

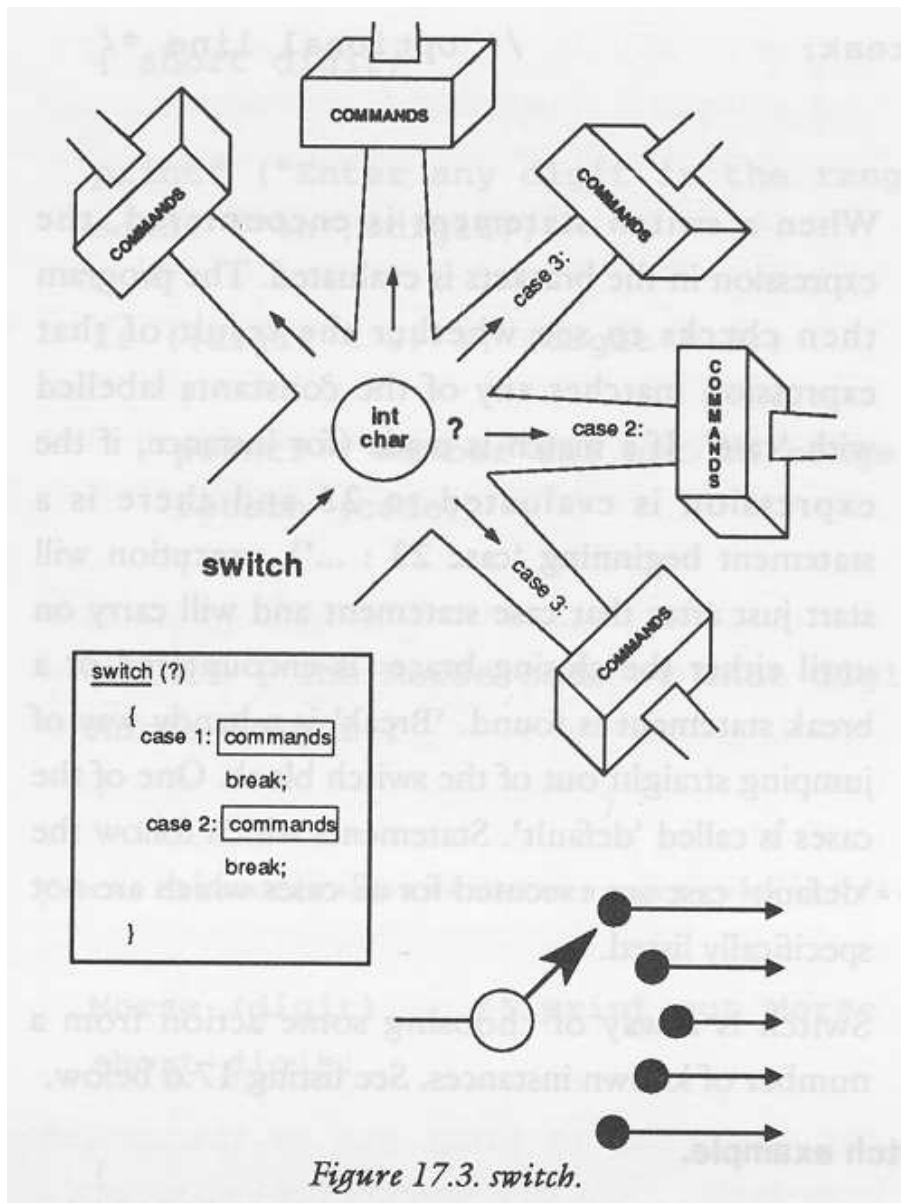

The switch statement can be written more specifically for integers:

```
switch (integer value)
{
  case 1: statement1;
          break;           /* optional line */

  case 2: statement2;
          break;           /* optional line */

  ....

  default: default statement
           break;         /* optional line */
}
```

When a switch statement is encountered, the expression in the parentheses is evaluated and the program checks to see whether the result of that expression matches any of the constants labelled with **case**. If a match is made (for instance, if the expression is evaluated to 23 and there is a statement beginning "case 23 : ...") execution will start just after that case statement and will carry on until either the closing brace **}** is encountered or a **break** statement is found. **break** is a handy way of jumping straight out of the switch block. One of the cases is called **default**. Statements which follow the **default** case are executed for all cases which are not specifically listed. **switch** is a way of choosing some action from a number of known instances. Look at the following example.

## 16.8 Example Listing

```
/******  
/*                                     */  
/* switch .. case                       */  
/*                                     */  
/******  
  
/* Morse code program. Enter a number and */  
/* find out what it is in Morse code      */  
  
#include <stdio.h>  
  
#define CODE 0  
  
/******  
  
main ()  
  
{ short digit;
```

```

printf ("Enter any digit in the range 0..9");

scanf ("%h",&digit);

if ((digit < 0) || (digit > 9))
{
    printf ("Number was not in range 0..9");
    return (CODE);
}

printf ("The Morse code of that digit is ");
Morse (digit);
}

/*****/

Morse (digit)      /* print out Morse code */

short digit;

{
switch (digit)
{
    case 0 : printf ("-----");
              break;
    case 1 : printf (".----");
              break;
    case 2 : printf ("..---");
              break;
    case 3 : printf ("...--");
              break;
    case 4 : printf ("....-");
              break;
    case 5 : printf (".....");
              break;
    case 6 : printf ("-....");
              break;
    case 7 : printf ("---...");
              break;
    case 8 : printf ("---..");
              break;
    case 9 : printf ("----.");
              break;
}
}

```

The program selects one of the `printf` statements using a `switch` construction. At every `case` in the `switch`, a `break` statement is used. This causes control to jump straight out of the `switch` statement to its closing brace `}`. If `break` were not included it would go right on executing the statements to the end,

testing the cases in turn. `break` this gives a way of jumping out of a `switch` quickly.

There might be cases where it is not necessary or not desirable to jump out of the `switch` immediately. Think of a function `yes()` which gets a character from the user and tests whether it was 'y' or 'Y'.

```
yes ()          /* A sloppy but simple function */

{
switch (getchar())
{
case 'y' :
case 'Y' : return TRUE
default  : return FALSE
}
}
```

If the character is either 'y' or 'Y' then the function meets the statement `return TRUE`. If there had been a `break` statement after case 'y' then control would not have been able to reach case 'Y' as well. The `return` statement does more than `break` out of `switch`, it breaks out of the whole function, so in this case `break` was not required. The default option ensures that whatever else the character is, the function returns false.

## 16.9 Things to try

1. Write a program to get a lot of numbers from the user and print out the maximum and minimum of those.
2. Try to make a counter which is reset to zero when it reaches 9999.
3. Try to write a program incorporating the statement `if (yes()) {...}`.





## 17 Loops

*Controlling repetitive processes. Nesting loops*

Decisions can also be used to make up loops. Loops free a program from the straitjacket of doing things only once. They allow the programmer to build a sequence of instructions which can be executed again and again, with some condition deciding when they will stop. There are three kinds of loop in C. They are called:

- `while`
- `do ... while`
- `for`

These three loops offer a great amount of flexibility to programmers and can be used in some surprising ways!

### 17.1 `while`

The simplest of the three loops is the `while` loop. In common language `while` has a fairly obvious meaning: the `while`-loop has a condition:

```
while (condition)
{
    statements;
}
```

and the statements in the curly braces are executed while the condition has the value "true" ( 1 ). There are dialects of English, however, in which

"while" does not have its commonplace meaning, so it is worthwhile explaining the steps which take place in a while loop.

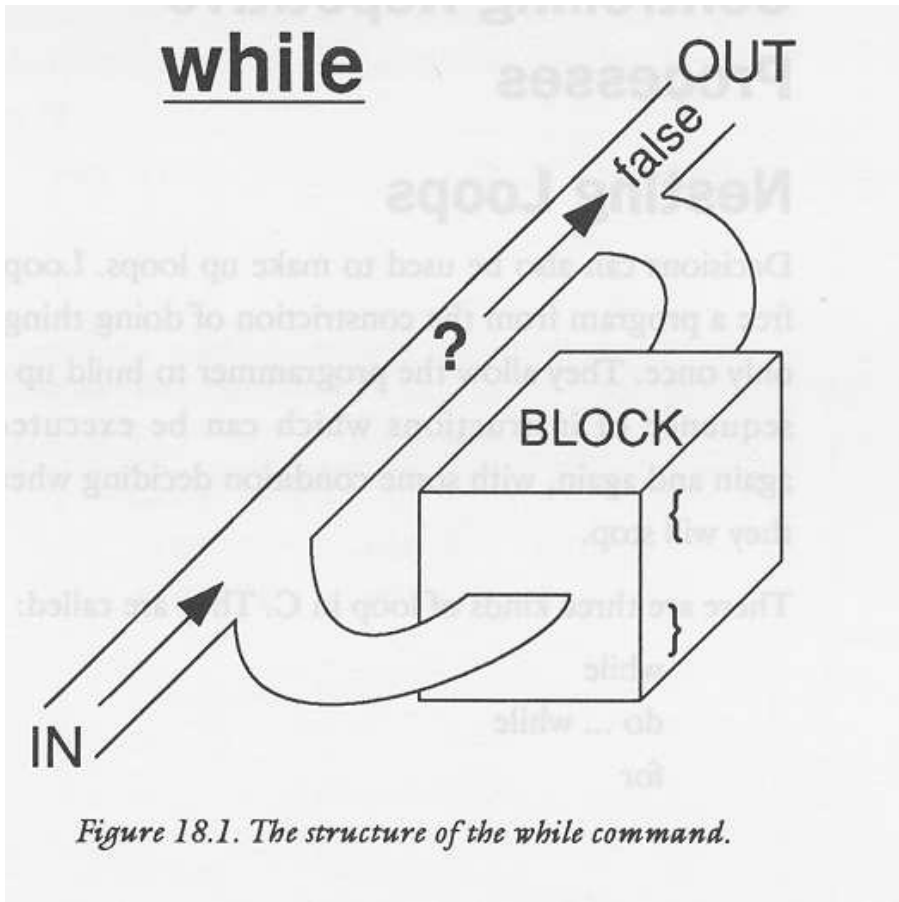

The first important thing about this loop is that it has a conditional expression (something like  $(a > b)$  etc...) which is evaluated every time the loop is executed by the computer. If the value of the expression is true, then it will carry on with the instructions in the curly braces. If the expression evaluates to **false** (or 0) then the instructions in the braces are ignored and the entire while loop ends. The computer then moves onto the next statement in the program.

The second thing to notice about this loop is that the conditional expression comes at the start of the loop: this means that the condition is tested at the start of every 'pass', not at the end. The reason that this is important is this: if the condition has the value false before the loop has been executed even once, the statements inside the braces will not get executed at all – not even once.

The best way to illustrate a loop is to give an example of its use. One example was sneaked into an earlier chapter before its time, in order to write the `skipgarb()` function which complemented `scanf()`. That was:

```
skipgarb ()          /* skip garbage corrupting scanf */

{
while (getchar() != '\n')
    {
    }
}
```

This is a slightly odd use of the while loop which is pure C, through and through. It is one instance in which the programmer has to start thinking C and not any other language. Something which is immediately obvious from listing is that the while loop in `skipgarb()` is empty: it contains no statements. This is quite valid: the loop will merely do nothing a certain number of times... at least it would do nothing if it were not for the assignment in the conditional expression! It could also be written:

```
skipgarb ()          /* skip garbage corrupting scanf */

{
while (getchar() != '\n')
    {
    }
}
```

The assignment inside the conditional expression makes this loop special. What happens is the following. When the loop is encountered, the computer attempts to evaluate the expression inside the parentheses. There, inside the parentheses, it finds a function call to `getchar()`, so it calls `getchar()` which fetches the next character from the input. `getchar()` then takes on the value of the character which it fetched from the input file. Next the computer finds the `!=` "is not equal to" symbol and the newline character `\n`. This means that there is a comparison to be made. The computer compares the character fetched by `getchar()` with the newline character and if they are 'not equal' the expression is true. If they are equal the expression is false. Now, if the expression is true, the while statement will loop and start again – and it will evaluate the expression on every pass of the loop to check whether or not it is true. When the expression eventually becomes false the loop will quit. The net result of this subtlety is that `skipgarb()` skips all the input characters up to and including the next newline '`\n`' character and that usually means the rest of the input.

## 17.2 Example Listing

Another use of while is to write a better function called `yes()`. The idea of this function was introduced in the previous section. It uses a while loop

which is always true to repeat the process of getting a response from the user. When the response is either yes or no it quits using the `return` function to jump right out of the loop.

```

/*****
/*
/* Give me your answer!
/*
/*
/*****

#include <stdio.h>

#define TRUE 1
#define FALSE 0

/*****
/* Level 0
/*
/*****

main ()

{
printf ("Yes or no? (Y/N)\n");

if (yes())
{
printf ("YES!");
}
else
{
printf ("NO!");
}
}

/*****
/* Level 1
/*
/*****

yes ()          /* get response Y/N query */

{ char getkey();

while (true)
{
switch (getkey())
{
case 'y' : case 'Y' : return (TRUE);
case 'n' : case 'N' : return (FALSE);
}
}
}

```

```

/*****
/* Toolkit */
*****/

char getkey () /* get a character + RETURN */

{ char ch;

ch = getchar();
skipgarb();
}

/*****

skipgarb ()

{
while (getchar() != '\n')
{
}
}

/* end */

```

### 17.3 Example Listing

This example listing prompts the user to type in a line of text and it counts all the spaces in that line. It quits when there is no more input left and printf out the number of spaces.

```

/*****
/*
/* while loop */
/* */
*****/

/* count all the spaces in an line of input */

#include <stdio.h>

main ()

{ char ch;
short count = 0;

printf ("Type in a line of text\n");

while ((ch = getchar()) != '\n')

```

```

    {
    if (ch == ' ')
        {
        count++;
        }
    }

printf ("Number of space = %d\n",count);
}

```

## 17.4 do..while

The `do..while` loop resembles most closely the `repeat..until` loops of Pascal and BASIC except that it is the 'logical opposite'. The `do` loop has the form:

```

do
{
    statements;
}

while (condition)

```

Notice that the condition is at the end of this loop. This means that a `do..while` loop will always be executed at least once, before the test is made to determine whether it should continue. This is the only difference between `while` and `do..while`.

A `do..while` loop is like the "repeat .. until" of other languages in the following sense: if the condition is NOTed using the '!' operator, then the two are identical.

```

repeat                do
                    ==
until(condition)     while (!condition)

```

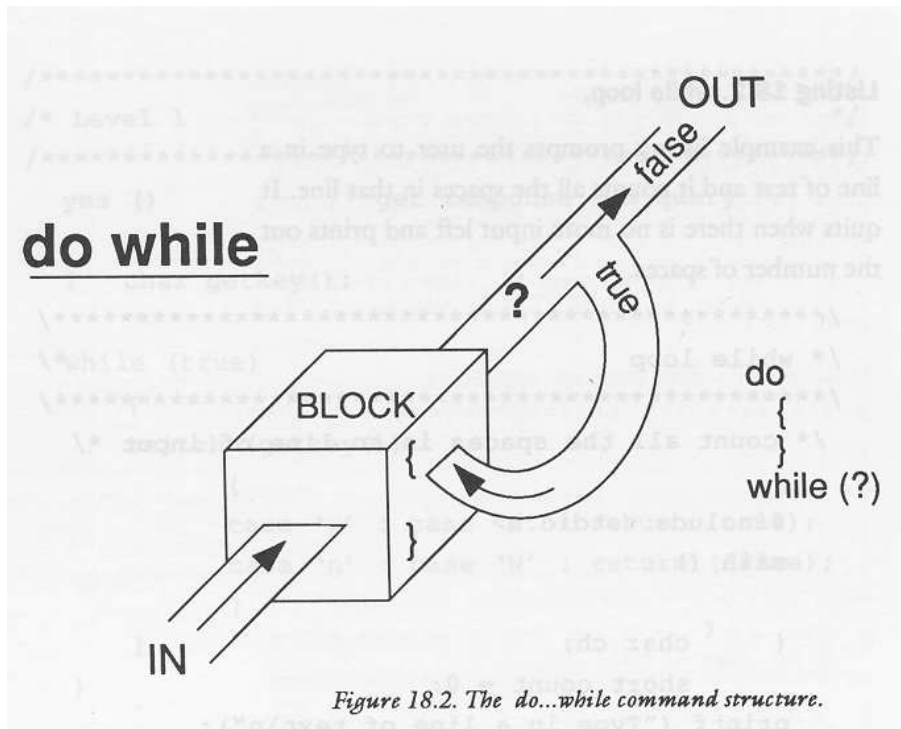

This fact might be useful for programmers who have not yet learned to think in C!

### 17.5 Example Listing

Here is an example of the use of a `do..while` loop. This program gets a line of input from the user and checks whether it contains a string marked out with `"` quote marks. If a string is found, the program prints out the contents of the string only. A typical input line might be:

```
Once upon a time "Here we go round the..."what a terrible..
```

The output would then be:

```
Here we go round the...
```

If the string has only one quote mark then the error message 'string was not closed before end of line' will be printed.

```
/*
*****
*/
```

```

/* do .. while demo                                     */
/*                                                     */
/*****/

/* print a string enclosed by quotes " " */
/* gets input from stdin i.e. keyboard */
/* skips anything outside the quotes */

#include <stdio.h>

/*****/
/* Level 0                                             */
/*****/

main ()

{ char ch,skipstring();

do
  {
  if ((ch = getchar()) == '"')
    {
    printf ("The string was:\n");
    ch = skipstring();
    }
  }

while (ch != '\n')
  {
  }
}

/*****/
/* Level 1                                             */
/*****/

char skipstring () /* skip a string "... " */

{ char ch;

do
  {
  ch = getchar();
  putchar(ch);

  if (ch == '\n')
    {
    printf ("\nString was not closed ");
    printf ("before end of line\n");
    break;
    }
  }
}

```



```

    }

    while (ch != '\0')
    {
    }

    return (ch);
}

```

## 17.6 for

The most interesting and also the most difficult of all the loops is the for loop. The name `for` is a hangover from earlier days and other languages. It is not altogether appropriate for C's version of `for`. The name comes from the typical description of a classic for loop:

For all values of *variable* from *value1* to *value2* in steps of *value3*, repeat the following sequence of commands....

In BASIC this looks like:

```

FOR variable = value1 TO value2 STEP value3

NEXT variable

```

The C for loop is much more versatile than its BASIC counterpart; it is actually based upon the `while` construction. A `for` loop normally has the characteristic feature of controlling one particular variable, called the control variable. That variable is somehow associated with the loop. For example it might be a variable which is used to count "for values from 0 to 10" or whatever. The form of the for loop is:

```

for (statement1; condition; statement2)
{
}

```

For normal usage, these expressions have the following significance.

*statement1*

This is some kind of expression which initializes the control variable. This statement is only carried out once before the start of the loop. e.g. `i = 0;`

*condition*

This is a condition which behaves like the while loop. The condition is evaluated at the beginning of every loop and the loop is only carried out while this expression is true. e.g. `i < 20;`

*statement2*

This is some kind of expression for altering the value of the control variable. In languages such as Pascal this always means

adding or subtracting 1 from the variable. In C it can be absolutely anything. e.g. `i++` or `i *= 20` or `i /= 2.3 ...`

Compare a C for loop to the BASIC for loop. Here is an example in which the loop counts from 0 to 10 in steps of 0.5:

```
FOR X = 0 TO 10 STEP 0.5
NEXT X

for (x = 0; x <= 10; x += 0.5)
{
}
```

The C translation looks peculiar in comparison because it works on a subtly different principle. It does not contain information about when it will stop, as the BASIC one does, instead it contains information about when it should be looping. The result is that a C for loop often has the `<=` symbol in it. The for loop has plenty of uses. It could be used to find the sum of the first `n` natural numbers very simply:

```
sum = 0;

for (i = 0; i <= n; i++)
{
    sum += i;
}
```

It generally finds itself useful in applications where a single variable has to be controlled in a well determined way.

g4

## 17.7 Example Listing

This example program prints out all the primes numbers between 1 and the macro value `maxint`. Prime numbers are numbers which cannot be divided by any number except 1 without leaving a remainder.

```
/******
/*
/* Prime Number Generator #1
/*
/******

/* Check for prime number by raw number */
/* crunching. Try dividing all numbers */
/* up to half the size of a given i, if */
/* remainder == 0 then not prime! */
```

```

#include <stdio.h>

#define MAXINT 500
#define TRUE 1
#define FALSE 0

/*****
/* Level 0 */
*****/

main ()

{ int i;

for (i = 2; i <= MAXINT; i++)
    {
    if (prime(i))
        {
        printf ("%5d",i);
        }
    }
}

/*****
/* Level 1 */
*****/

prime (i)      /* check for a prime number */

int i;

{ int j;

for (j = 2; j <= i/2; j++)
    {
    if (i % j == 0)
        {
        return FALSE;
        }
    }

return TRUE;
}

```

## 17.8 The flexible for loop

The word ‘statement’ was chosen carefully, above, to describe what goes into a for loop. Look at the loop again:

```

for (statement1; condition; statement2)
    {

```

```
    }
```

Statement really means what it says. C will accept any statement in the place of those above, including the empty statement. The while loop could be written as a for loop!

```
for (; condition; )    /* while ?? */
{
}
```

Here there are two empty statements, which are just wasted. This flexibility can be put to better uses though. Consider the following loop:

```
for (x = 2; x <= 1000; x = x * x)
{
    ....
}
```

This loop begins from 2 and each time the statements in the braces are executed  $x$  squares itself! Another odd looking loop is the following one:

```
for (ch = '*'; ch != '\n'; ch = getchar())
{
}
```

This could be used to make yet another different kind of `skipgarb()` function. The loop starts off by initializing `ch` with a star character. It checks that `ch != '\n'` (which it isn't, first time around) and proceeds with the loop. On each new pass, `ch` is reassigned by calling the function `getchar()`. It is also possible to combine several incremental commands in a loop:

```
for (i = 0, j=10; i < j; i++, j--)
{
    printf("i = %d, j= %d\n",i,j);
}
```

*Statement2* can be any statement at all which the programmer would like to be executed on every pass of the loop. Why not put that statement in the curly braces? In most cases that would be the best thing to do, but in special instances it might keep a program tidier or more readable to put it in a for loop instead. There is no good rule for when to do this, except to say: make you code as clear as possible.

It is not only the statements which are flexible. An unnerving feature of the for construction (according to some programmers) is that even the conditional expression in the for loop can be altered by the program from within the loop itself if is written as a variable.

```
int i, number = 20;
```

```

for (i = 0; i <= number; i++)
{
    if (i == 9)
    {
        number = 30;
    }
}

```

This is so nerve shattering that many languages forbid it outright. To be sure, is not often a very good idea to use this facility, but in the right hands, it is a powerful one to have around.

## 17.9 Quitting Loops and Hurrying Them Up!

C provides a simple way of jumping out of any of the three loops above at any stage, whether it has finished or not. The statement which performs this action is the same statement which was used to jump out of `switch` statements in last section.

```
break;
```

If this statement is encountered a loop will quit where it stands. For instance, an expensive way of assigning `i` to be 12 would be:

```

for (i = 1; i <= 20; i++)
{
    if (i == 12)
    {
        break;
    }
}

```

Still another way of making `skipgarb()` would be to perform the following loop:

```

while (TRUE)
{
    ch = getchar();
    if (ch == '\n')
    {
        break;
    }
}

```

Of course, another way to do this would be to use the `return()` statement, which jumps right out of a whole function. `break` only jumps out of the loop, so it is less drastic.

As well as wanting to quit a loop, a programmer might want to hurry a loop on to the next pass: perhaps to avoid executing a lot of irrelevant statements, for instance. C gives a statement for this too, called:



```
    }  
    printf ("\n");  
  }  
}
```

The output of this program is a "kind of" square:

```
*****  
*****  
*****  
*****  
*****  
*****  
*****  
*****  
*****  
*****  
*****
```

## 17.11 Questions

1. How many kinds of loop does C offer, and what are they?
2. When is the condition tested in each of the loops?
3. Which of the loops is always executed once?
4. Write a program which copies all input to output line by line.
5. Write a program to get 10 numbers from the user and add them together.





## 18 Arrays

*Rows and tables of storage.*

Arrays are a convenient way of grouping a lot of variables under a single variable name. Arrays are like pigeon holes or chessboards, with each compartment or square acting as a storage place; they can be one dimensional, two dimensional or more dimensional! An array is defined using square brackets []. For example: an array of three integers called "triplet" would be declared like this:

```
int triplet[3];
```

Notice that there is no space between the square bracket [ and the name of the array. This statement would cause space for three integers type variables to be created in memory next to each other as in the diagram below.

```
int triplet:  |-----|-----|-----|
```

The number in the square brackets of the declaration is referred to as the 'index' (plural: indices) or 'subscript' of the array and it must be an integer number between 0 and (in this case) 2. The three integers are called elements of the array and they are referred to in a program by writing:

```
triplet[0]
triplet[1]
triplet[2]
```

Note that the indices start at zero and run up to one less than the number which is placed in the declaration (which is called the dimension of the array.) The reason for this will become clear later. Also notice that every element in an array is of the same type as every other. It is not (at this stage) possible to have arrays which contain many different data types. When arrays are declared inside a function, storage is allocated for them, but that storage space is not initialized: that is, the memory space contains garbage (random values). It is usually necessary, therefore, to initialize the array before the program truly begins, to prepare it for use. This usually means that all the elements in the array will be set to zero.

### 18.1 Why use arrays?

Arrays are most useful when they have a large number of elements: that is, in cases where it would be completely impractical to have a different name

for every storage space in the memory. It is then highly beneficial to move over to arrays for storing information for two reasons:

- The storage spaces in arrays have indices. These numbers can often be related to variables in a problem and so there is a logical connection to be made between an array and a program.
- In C, arrays can be initialized very easily indeed. It is far easier to initialize an array than it is to initialize twenty or so variables.

The first of these reasons is probably the most important one, as far as C is concerned, since information can be stored in other ways with equally simple initialization facilities in C. One example of the use of an array might be in taking a census of the types of car passing on a road. By defining macros for the names of the different cars, they could easily be linked to the elements in an array.

Type	Array Element
car	0
auto	1
bil	2

The array could then be used to store the number of cars of a given type which had driven past. e.g.

```

/*****/
/*                                     */
/* Census                             */
/*                                     */
/*****/

#include <stdio.h>

#define NOTFINISHED 1
#define CAR          0
#define AUTO         1
#define BIL          2

/*****/

main ()

{ int type[3];
  int index;

  for (index = 0; index < 3; index++)
    {
      type[index] = 0;
    }

  while (NOTFINISHED)
    {

```

```

printf ("Enter type number 0,1, or 2");
scanf ("%d", &index);
skipgarb();

type[index] += 1;      /* See text below */
}
}

```

This program, first of all, initializes the elements of the array to be zero. It then enters a loop which repeatedly fetches a number from the user and increases the value stored in the array element, labelled by that number, by 1. The effect is to count the cars as they go past. This program is actually not a very good program for two reasons in particular:

- Firstly, it does not check that the number which the user typed is actually one of the elements of the array. (See the section below about this.)
- The loop goes on for ever and the program never gives up the information which it stores. In short: it is not very useful.

Another example, which comes readily to mind, would be the use of a two dimensional array for storing the positions of chess pieces in a chess game. Two dimensional arrays have a chessboard-like structure already and they require two numbers (two indicies) to pinpoint a particular storage cell. This is just like the numbers on chess board, so there is an immediate and logical connection between an array and the problem of keeping track of the pieces on a chess board. Arrays play an important role in the handling of string variables. Strings are important enough to have a section of their own, See [\[Strings\]](#), page [\[undefined\]](#).

## 18.2 Limits and The Dimension of an array

C does not do much hand holding. It is invariably up to the programmer to make sure that programs are free from errors. This is especially true with arrays. C does not complain if you try to write to elements of an array which do not exist! For example:

```
char array[5];
```

is an array with 5 elements. If you wrote:

```
array[7] = '*';
```

C would happily try to write the character '\*' at the location which would have corresponded to the seventh element, had it been declared that way. Unfortunately this would probably be memory taken up by some other variable or perhaps even by the operating system. The result would be either:

- The value in the incorrect memory location would be corrupted with unpredictable consequences.
- The value would corrupt the memory and crash the program completely! On Unix systems this leads to a memory *segmentation fault*.

The second of these tends to be the result on operating systems with proper memory protection. Writing over the bounds of an array is a common source of error. Remember that the array limits run from zero to the size of the array minus one.

### 18.3 Arrays and for loops

Arrays have a natural partner in programs: the for loop. The `for` loop provides a simple way of counting through the numbers of an index in a controlled way. Consider a one dimensional array called `array`. A for loop can be used to initialize the array, so that all its elements contain zero:

```
#define SIZE 10;

main ()

{ int i, array[SIZE];

for (i = 0; i < SIZE; i++)
  {
    array[i] = 0;
  }
}
```

It could equally well be used to fill the array with different values. Consider:

```
#define SIZE 10;

main ()

{ int i, array[size];

for (i = 0; i < size; i++)
  {
    array[i] = i;
  }
}
```

This fills each successive space with the number of its index:

index	0	1	2	3	4	5	6	7	8	9
element	0	1	2	3	4	5	6	7	8	9
contents	-----									

The for loop can be used to work on an array sequentially at any time during a program, not only when it is being initialized. The example listing below shows an example of how this might work for a one dimensional array, called an Eratosthenes sieve. This sieve is an array which is used for weeding out prime numbers, that is: numbers which cannot be divided by any number except 1 without leaving a remainder or a fraction. It works by filling an array with numbers from 0 to some maximum value in the same way that was shown above and then by going through the numbers in turn and deleting (setting equal to zero) every multiple of every number from the array. This eliminates all the numbers which could be divided by something exactly and leaves only the prime numbers at the end. Try to follow the listing below.

## 18.4 Example Listing

```

/*****
/*
/* Prime Number Sieve
/*
*****/

#include <stdio.h>

#define SIZE      5000
#define DELETED   0

/*****
/* Level 0
*****/

main ()

{ short sieve[SIZE];

printf ("Eratosthenes Sieve \n\n");

FillSeive(sieve);
SortPrimes(sieve);
PrintPrimes(sieve);
}

/*****
/* Level 1
*****/

FillSeive (sieve)          /* Fill with integers */

short sieve[SIZE];

```

```

{ short i;

for (i = 2; i < SIZE; i++)
{
    sieve[i] = i;
}
}

/*****/

SortPrimes (sieve)          /* Delete non primes */

short sieve[SIZE];

{ short i;

for (i = 2; i < SIZE; i++)
{
    if (sieve[i] == DELETED)
    {
        continue;
    }
    DeleteMultiplesOf(i,sieve);
}
}

/*****/

PrintPrimes (sieve)        /* Print out array */

short sieve[SIZE];

{ short i;

for (i = 2; i < SIZE; i++)
{
    if (sieve[i] == DELETED)
    {
        continue;
    }
    else
    {
        printf ("%5d",sieve[i]);
    }
}
}

/*****/
/* Level 2 */
/*****/

DeleteMultiplesOf (i,sieve) /* Delete.. of an integer */

```

```

short i,sieve[SIZE];

{ short j, mult = 2;

for (j = i*2; j < SIZE; j = i * (mult++))
  {
  sieve[j] = DELETED;
  }
}

/* end */

```

## 18.5 Arrays Of More Than One Dimension

There is no limit, in principle, to the number of indicies which an array can have. (Though there is a limit to the amount of memory available for their storage.) An array of two dimensions could be declared as follows:

```
float numbers[SIZE][SIZE];
```

**SIZE** is some constant. (The sizes of the two dimensions do not have to be the same.) This is called a two dimensional array because it has two indicies, or two labels in square brackets. It has (**SIZE \* SIZE**) or size-squared elements in it, which form an imaginary grid, like a chess board, in which every square is a variable or storage area.

```

-----
| 0 | 1 | 2 | 3 | 4 | 5 | 6 | 7 | 8 | ... (up to SIZE)
-----
| 1 |   |   |   |   |   |   |   |   |
-----
| 2 |   |   |   |   |   |   |   |   |
-----
| 3 |   |   |   |   |   |   |   |   |
-----
| 4 |   |   |   |   |   |   |   |   |
-----
| 5 |   |   |   |   |   |   |   |   |
-----
| 6 |   |   |   |   |   |   |   |   |
-----
| 7 |   |   |   |   |   |   |   |   |
-----
.
.
(up to SIZE)

```

Every element in this grid needs two indicies to pin-point it. The elements are accessed by giving the coordinates of the element in the grid. For instance to set the element 2,3 to the value 12, one would write:

```
array[2][3] = 12;
```

The usual terminology for the two indicies is that the first gives the row number in the grid and that the second gives the column number in the grid. (Rows go along, columns hold up the ceiling.) An array cannot be stored in the memory as a grid: computer memory is a one dimensional thing. Arrays are therefore stored in rows. The following array:

```
-----
| 1 | 2 | 3 |
-----
| 4 | 5 | 6 |
-----
| 7 | 8 | 9 |
-----
```

would be stored:

```
-----
| 1 | 2 | 3 | 4 | 5 | 6 | 7 | 8 | 9 |
-----
* ROW # 1 * ROW # 2 * ROW #3 *
```

Another way of saying that arrays are stored row-wise is to say that the second index varies fastest, because a two-dimensional array is always thought of as...

```
array[row][column]
```

so for every row stored, there will be lots of columns inside that row. That means the column index goes from 0..SIZE inside every row, so it is changing faster as the line of storage is followed.

A three dimensional array, like a cube or a cuboid, could also be defined in the same kind of way:

```
double cube[SIZE][SIZE][SIZE];
```

or with different limits on each dimension:

```
short notcubic[2][6][8];
```

Three dimensional arrays are stored according to the same pattern as two dimensional arrays. They are kept in computer memory as a linear sequence of variable stores and the last index is always the one which varies fastest.



## 18.6 Arrays and Nested Loops

Arrays of more than one dimension are usually handled by nested for loops. A two dimensional array might be initialized in the following way:

```
main ()

{ int i,j;
  float array[SIZE1][SIZE2];

  for (i = 0; i < SIZE1; i++)
    {
      for (j = 0; j < SIZE2; j++)
        {
          array[i][j] = 0;
        }
    }
}
```

In three dimensions, three nested loops would be needed:

```
main ()

{ int i,j,k;
  float array[SIZE1][SIZE2][SIZE3];

  for (i = 0; i < SIZE1; i++)
    {
      for (j = 0; j < SIZE2; j++)
        {
          for (k = 0; k < SIZE3; k++)
            {
              array[i][j][k] = 0;
            }
        }
    }
}
```

An example program helps to show how this happens in practice. The example below demonstrates the so-called "Game of Life". The aim is to mimic something like cell reproduction by applying some rigid rules to a pattern of dots '.' and stars '\*'. A dot is a place where there is no life (as we know it!) and a star is a place in which there is a living thing. The rules will be clear from the listing. Things to notice are the way the program traverses the arrays and the way in which it checks that it is not overstepping the boundaries of the arrays.

## 18.7 Example Listing

```
/******
```

```

/*                                     */
/* Game of Life                       */
/*                                     */
/*****/

    /* Based upon an article from Scientific American */
    /* in 1970. Simulates the reproduction of cells */
    /* which depend on one another. The rules are */
    /* that cells will only survive if they have a */
    /* certain number of neighbours to support them */
    /* but not too many, or there won't be enough */
    /* food!                                     */

#include <stdio.h>

#define SIZE          20
#define MAXNUM        15
#define INBOUNDS      (a>=0)&&(a<SIZE)&&(b>=0)&&(b<SIZE)
#define NORESPONSE    1

/*****/
/* Level 0                                     */
/*****/

main ()

{ int count[SIZE][SIZE];
  char array[SIZE][SIZE];
  int generation = 0;

printf ("Game of Life\n\n\n");
InitializeArray(array);

while (NORESPONSE)
{
    CountNeighbours(array,count);
    BuildNextGeneration(array,count);
    UpdateDisplay(array,++generation);

    printf ("\n\nQ for quit. RETURN to continue.\n");
    if(quit()) break;
}

/*****/
/* Level 1                                     */
/*****/

InitializeArray (array)    /* Get starting conditions */

char array[SIZE][SIZE];

```

```

{ int i,j;
  char ch;

printf ("\nEnter starting setup. Type '.' for empty");
printf ("\nand any other character for occupied.\n");
printf ("RETURN after each line.\n\n");
printf ("Array size guide:\n\n");

for (i=0; i++ < SIZE; printf("%c",'^'));
printf ("\n\n");

for (i = 0; i < SIZE; i++)
  {
  for (j = 0; j < SIZE; j++)
    {
    scanf ("%c",&ch);
    if (ch == '.')
      {
      array[i][j] = '.';
      }
    else
      {
      array[i][j] = '*';
      }
    }
  skipgarb();
  }

printf ("\n\nInput is complete. Press RETURN.");
skipgarb();
}

/*****/

CountNeighbours (array,count) /* count all neighbours */

char array[SIZE][SIZE];
int count[SIZE][SIZE];

{ int i,j;

for (i = 0; i < SIZE; i++)
  {
  for (j = 0; j < SIZE; j++)
    {
    count[i][j] = numalive(array,i,j);
    }
  }
}

/*****/

```

```

BuildNextGeneration (array,count)

/* A cell will survive if it has two or three */
/* neighbours. New life will be born to a dead */
/* cell if there are exactly three neighbours */

char array[SIZE][SIZE];
int count[SIZE][SIZE];

{ int i,j;

for (i = 0; i < SIZE; i++)
  {
  for (j = 0; j < SIZE; j++)
    {
    if (array[i][j] == '*')
      {
      switch (count[i][j])
        {
        case 2 :
        case 3 : continue;

        default: array[i][j] = '.';
                  break;
        }
      }
    else
      {
      switch (count[i][j])
        {
        case 3 : array[i][j] = '*';
                  break;
        default: continue;
        }
      }
    }
  }
}

/*****/

UpdateDisplay (array,g) /* print out life array */

char array[SIZE][SIZE];
int g;

{ int i,j;

printf ("\n\nGeneration %d\n\n",g);

for (i = 0; i < SIZE; i++)
  {

```

```

    for (j = 0; j < SIZE; j++)
    {
        printf("%c",array[i][j]);
    }
    printf("\n");
}

/*****
/* Level 2 */
*****/

numalive (array,i,j)

/* Don't count array[i,j] : only its neighbours */
/* Also check that haven't reached the boundary */
/* of the array */

char array[SIZE][SIZE];
int i,j;

{ int a,b,census;

census = 0;

for (a = (i-1); (a <= (i+1)); a++)
{
    for (b = (j-1); (b <= (j+1)); b++)
    {
        if (INBOUNDS && (array[a][b] == '*'))
        {
            census++;
        }
    }
}

if (array[i][j] == '*') census--;

return (census);
}

/*****
/* Toolkit input */
*****/

quit()

{ char ch;

while (NORESPONSE)
{
    scanf ("%c",&ch);

```









```

..*.....*..
...*****...
.....
.....
.....
.....
.....
.....

```

Q for quit. RETURN to continue.

etc... Try experimenting with different starting patterns.

## 18.9 Initializing Arrays

Arrays can be initialized in two ways. The first way is by assigning every element to some value with a statement like:

```

array[2] = 42;
array[3] = 12;

```

or perhaps with the aid of one or more for loops. Because it is tedious, to say the least, not to mention uneconomical, to initialize the values of each element to as different value, C provides another method, which employs a single assignment operator '=' and curly braces { }. *This method only works for static variables and external variables.*

Recall that arrays are stored row-wise or with the last index varying fastest. A 3 by 3 array could be initialized in the following way:

```

static int array[3][3] =
{
  {10,23,42},
  {1,654,0},
  {40652,22,0}
};

```

The internal braces are unnecessary, but help to distinguish the rows from the columns. The same thing could be written:

```

int array[3][3] =
{
  10,23,42,
  1,654,0
  40652,22,0
};

```

Take care to include the semicolon at the end of the curly brace which closes the assignment.

Note that, if there are not enough elements in the curly braces to account for every single element in an array, the remaining elements will be filled out with zeros. Static variables are always guaranteed to be initialized to zero anyway, whereas auto or local variables are guaranteed to be garbage: this is because static storage is created by the compiler in the body of a program, whereas auto or local storage is created at run time.

## 18.10 Arrays and Pointers

The information about how arrays are stored was not included just for interest. There is another way of looking at arrays which follows the BCPL idea of an array as simply a block of memory. An array can be accessed with pointers as well as with [] square brackets.

*The name of an array variable, standing alone, is actually a pointer to the first element in the array.*

For example: if an array is declared

```
float numbers[34];
```

then `numbers` is a pointer to the first floating point number in the array; `numbers` is a pointer in its own right. (In this case it is type 'pointer to float'.) So the first element of the array could be accessed by writing:

```
numbers[0] = 22.3;
```

or by writing

```
*numbers = 22.3;
```

For character arrays, which are dealt with in some depth in chapter 20, this gives an alternative way of getting at the elements in the array.

```
char arrayname[5];
char *ptr;

for (ptr = arrayname; ptr <= arrayname+4; ptr++)
{
    *ptr = 0;
}
```

The code above sets the array `arrayname` to zero. This method of getting at array data is not recommended by this author except in very simple computer environments. If a program is running on a normal microcomputer, then there should be few problems with this alternative method of handling arrays. On the hand, if the microcomputer is multi-tasking, or the program is running on a larger system which has a limited manager, then memory ceases to be something which can be thought of as a sequence of boxes standing next to one another. A multi-tasking system shares memory with

other programs and it takes what it can find, where it can find it. The upshot of this is that it is not possible to guarantee that arrays will be stored in one simple string of memory locations: it might be scattered around in different places. So

```
ptr = arrayname + 5;
```

might not be a pointer to the fifth character in a character array. This could be found instead using the '&' operator. A pointer to the fifth element can be reliably found with:

```
ptr = &(arrayname[5]);
```

Be warned!

## 18.11 Arrays as Parameters

What happens if we want to pass an array as a parameter? Does the program copy the entire array into local storage? The answer is no because it would be a waste of time and memory. Arrays can be passed as parameters, but only as variable ones. This is a simple matter, because the name of the array is a pointer to the array. The Game of Life program above does this. Notice from that program how the declarations for the parameters are made.

```
main ()
{
char array[23];

function (array);

.....
}

function (arrayformal)

char arrayformal[23];

{
}
```

Any function which writes to the array, passed as a parameter, will affect the original copy. Array parameters are always variable parameters

## 18.12 Questions

1. Given any array, how would you find a pointer to the start of it?
2. How do you pass an array as a parameter? When the parameter is received by a function does C allocate space for a local variable and copy the whole array to the new location?

3. Write a statement which declares an array of type double which measures 4 by 5. What numbers can be written in the indices of the array?

## 19 Strings

*Communication with arrays.*

Strings are pieces of text which can be treated as values for variables. In C a string is represented as some characters enclosed by double quotes.

```
"This is a string"
```

A string may contain any character, including special control characters, such as '\n', '\r', '\7' etc...

```
"Beep! \7 Newline \n..."
```

### 19.1 Conventions and Declarations

There is an important distinction between a string and a single character in C. The convention is that single characters are enclosed by single quotes e.g. '\*' and have the type char. Strings, on the hand, are enclosed by double quotes e.g. "string..." and have the type "pointer to char" '(char \*)' or array of char. Here are some declarations for strings which are given without immediate explanations.

```

/*****
/*
/* String Declaration
/*
/*
/*****

#define SIZE    10

char *global_string1;
char  global_string2[SIZE];

main ()

{ char *auto_string;
  char  arraystr[SIZE];
  static char *stat_strng;
  static char statarraystr[SIZE];

}

```

## 19.2 Strings, Arrays and Pointers

A string is really an array of characters. It is stored at some place the memory and is given an end marker which standard library functions can recognize as being the end of the string. The end marker is called the zero (or NULL) byte because it is just a byte which contains the value zero: `'\0'`. Programs rarely gets to see this end marker as most functions which handle strings use it or add it automatically.

Strings can be declared in two main ways; one of these is as an array of characters, the other is as a pointer to some pre-assigned array. Perhaps the simplest way of seeing how C stores arrays is to give an extreme example which would probably never be used in practice. Think of how a string called `string` might be used to store the message "Tedious!". The fact that a string is an array of characters might lead you to write something like:

```
#define LENGTH 9;

main ()

{ char string[LENGTH];

string[0] = 'T';
string[1] = 'e';
string[2] = 'd';
string[3] = 'i';
string[4] = 'o';
string[5] = 'u';
string[6] = 's';
string[7] = '!';
string[8] = '\0';

printf ("%s", string);
}
```

This method of handling strings is perfectly acceptable, if there is time to waste, but it is so laborious that C provides a special initialization service for strings, which bypasses the need to assign every single character with a new assignment!. There are six ways of assigning constant strings to arrays. (A constant string is one which is actually typed into the program, not one which is typed in by the user.) They are written into a short compilable program below. The explanation follows.

```
/******
/*
/* String Initialization
/*
/*
/******

char *global_string1 = "A string declared as a pointer";
```

```

char global_string2[] = "Declared as an array";

main ()
{
    char *auto_string = "initializer...";

    static char *stat_strng = "initializer...";

    static char statarraystr[] = "initializer...";

    /* char arraystr[] = "initializer..."; IS ILLEGAL! */
    /* This is because the array is an "auto" type      */
    /* which cannot be preinitialized, but...          */

    char arraystr[20];

    printf ("%s %s", global_string1, global_string2);
    printf ("%s %s %s", auto_string, stat_strng, statarraystr);
}

/* end */

```

The details of what goes on with strings can be difficult to get to grips with. It is a good idea to get revise pointers and arrays before reading the explanations below. Notice the diagrams too: they are probably more helpful than words.

The first of these assignments is a global, static variable. More correctly, it is a pointer to a global, static array. Static variables are assigned storage space in the body of a program when the compiler creates the executable code. This means that they are saved on disk along with the program code, so they can be initialized at compile time. That is the reason for the rule which says that only static arrays can be initialized with a constant expression in a declaration. The first statement allocates space for a pointer to an array. Notice that, because the string which is to be assigned to it, is typed into the program, the compiler can also allocate space for that in the executable file too. In fact the compiler stores the string, adds a zero byte to the end of it and assigns a pointer to its first character to the variable called `global_string1`.

The second statement works almost identically, with the exception that, this time the compiler sees the declaration of a static array, which is to be initialized. Notice that there is no size declaration in the square brackets. This is quite legal in fact: the compiler counts the number of characters in the initialization string and allocates just the right amount of space, filling the string into that space, along with its end marker as it goes. Remember also that the name of the array is a pointer to the first character, so, in fact, the two methods are identical.

The third expression is the same kind of thing, only this time, the declaration is inside the function `main()` so the type is not static but auto. The difference between this and the other two declarations is that this pointer variable is created every time the function `main()` is called. It is new each time and the same thing holds for any other function which it might have been defined in: when the function is called, the pointer is created and when it ends, it is destroyed. The string which initializes it is stored in the executable file of the program (because it is typed into the text). The compiler returns a value which is a pointer to the string's first character and uses that as a value to initialize the pointer with. This is a slightly round about way of defining the string constant. The normal thing to do would be to declare the string pointer as being static, but this is just a matter of style. In fact this is what is done in the fourth example.

The fifth example is again identical, in practice to other static types, but is written as an 'open' array with an unspecified size.

The sixth example is forbidden! The reason for this might seem rather trivial, but it is made in the interests of efficiency. The array declared is of type auto: this means that the whole array is created when the function is called and destroyed afterwards. auto-arrays cannot be initialized with a string because they would have to be re-initialized every time the array were created: that is, each time the function were called. The final example could be used to overcome this, if the programmer were inclined to do so. Here an auto array of characters is declared (with a size this time, because there is nothing for the compiler to count the size of). There is no single assignment which will fill this array with a string though: the programmer would have to do it character by character so that the inefficiency is made as plain as possible!

### 19.3 Arrays of Strings

In the previous chapter we progressed from one dimensional arrays to two dimensional arrays, or arrays of arrays! The same thing works well for strings which are declared static. Programs can take advantage of C's easy assignment facilities to let the compiler count the size of the string arrays and define arrays of messages. For example here is a program which prints out a menu for an application program:

```

/*****/
/*
/* MENU : program which prints out a menu
/*
/*
/*****/

main ()

{ int str_number;

```



```

for (str_number = 0; str_number < 13; str_number++)
{
    printf ("%s",menutext(str_number));
}
}

/*****/

char *menutext(n)          /* return n-th string ptr */

int n;

{
    static char *t[] =
    {
        " | ----- \n",
        " |          ++ MENU ++ | \n",
        " |          ~~~~~~ | \n",
        " |      (1) Edit Defaults | \n",
        " |      (2) Print Charge Sheet | \n",
        " |      (3) Print Log Sheet | \n",
        " |      (4) Bill Calculator | \n",
        " |      (q) Quit | \n",
        " | | \n",
        " | | \n",
        " |      Please Enter Choice | \n",
        " | | \n",
        " | ----- \n"
    };
    return (t[n]);
}

```

Notice the way in which the static declaration works. It is initialized once at compile time, so there is effectively only one statement in this function and that is the return statement. This function retains the pointer information from call to call. The Morse coder program could be rewritten more economically using static strings, See [\[Example 15\]](#), page [\[Example 15\]](#).

## 19.4 Example Listing

```

/*****/
/*                               */
/* static string array           */
/*                               */
/*****/

/* Morse code program. Enter a number and */
/* find out what it is in Morse code      */

#include <stdio.h>

```

```

#define CODE 0

/*****/

main ()

{ short digit;

printf ("Enter any digit in the range 0..9");

scanf ("%h",&digit);

if ((digit < 0) || (digit > 9))
{
printf ("Number was not in range 0..9");
return (CODE);
}

printf ("The Morse code of that digit is ");
Morse (digit);
}

/*****/

Morse (digit)      /* print out Morse code */

short digit;

{
static char *code[] =
{
"dummy",          /* index starts at 0 */
"-----",
".----",
"..---",
"...--",
"....-",
".....",
"_....",
"--...",
"----.",
"-----."
};

printf ("%s\n",code[digit]);
}

```

## 19.5 Strings from the user

All the strings mentioned so far have been typed into a program by the programmer and stored in a program file, so it has not been necessary to worry about where they were stored. Often though we would like to fetch a string from the user and store it somewhere in the memory for later use. It might even be necessary to get a whole bunch of strings and store them all. But how will the program know in advance how much array space to allocate to these strings? The answer is that it won't, but that it doesn't matter at all!

One way of getting a simple, single string from the user is to define an array and to read the characters one by one. An example of this was the Game of Life program the the previous chapter:

- Define the array to be a certain size
- Check that the user does not type in too many characters.
- Use the string in that array.

Another way is to define a static string with an initializer as in the following example. The function `filename()` asks the user to type in a filename, for loading or saving by and return it to a calling function.

```
char *filename()

{ static char *filenm = ".....";

do
{
printf ("Enter filename :");
scanf ("%24s",filenm);
skipgarb();
}
while (strlen(filenm) == 0);
return (filenm);
}
```

The string is made static and given an initializing expression and this forces the compiler to make some space for the string. It makes exactly 24 characters plus a zero byte in the program file, which can be used by an application. Notice that the conversion string in `scanf` prevents the characters from spilling over the bounds of the string. The function `strlen()` is a standard library function which is described below; it returns the length of a string. `skipgarb()` is the function which was introduced in chapter 15.

Neither of the methods above is any good if a program is going to be fetching a lot of strings from a user. It just isn't practical to define lots of static strings and expect the user to type into the right size boxes! The next step in string handling is therefore to allocate memory for strings personally: in other words to be able to say how much storage is needed for a string while a program is running. C has special memory allocation functions which can

do this, not only for strings but for any kind of object. Suppose then that a program is going to get ten strings from the user. Here is one way in which it could be done:

1. Define one large, static string (or array) for getting one string at a time. Call this a string buffer, or waiting place.
2. Define an array of ten pointers to characters, so that the strings can be recalled easily.
3. Find out how long the string in the string buffer is.
4. Allocate memory for the string.
5. Copy the string from the buffer to the new storage and place a pointer to it in the array of pointers for reference.
6. Release the memory when it is finished with.

The function which allocates memory in C is called `malloc()` and it works like this:

- `malloc()` should be declared as returning the type pointer to character, with the statement:

```
char *malloc();
```

- `malloc()` takes one argument which should be an unsigned integer value telling the function how many bytes of storage to allocate. It returns a pointer to the first memory location in that storage:

```
char *ptr;
unsigned int size;

ptr = malloc(size);
```

- The pointer returned has the value `NULL` if there was no memory left to allocate. This should always be checked.

The fact that `malloc()` always returns a pointer to a character does not stop it from being used for other types of data too. The cast operator can force `malloc()` to give a pointer to any data type. This method is used for building data structures in C with "struct" types.

`malloc()` has a complementary function which does precisely the opposite: de-allocates memory. This function is called `free()`. `free()` returns an integer code, so it does not have to be declared as being any special type.

- `free()` takes one argument: a pointer to a block of memory which has previously been allocated by `malloc()`.

```
int returncode;

returncode = free (ptr);
```

- The pointer should be declared:

```
char *ptr;
```

- The return code is zero if the release was successful.

An example of how strings can be created using `malloc()` and `free()` is given below. First of all, some explanation of Standard Library Functions is useful to simplify the program.

## 19.6 Handling strings

The C Standard Library commonly provides a number of very useful functions which handle strings. Here is a short list of some common ones which are immediately relevant (more are listed in the following chapter). Chances are, a good compiler will support a lot more than those listed below, but, again, it really depends upon the compiler.

**strlen()** This function returns a type `int` value, which gives the length or number of characters in a string, not including the `NULL` byte end marker. An example is:

```
int len;
char *string;
len = strlen (string);
```

**strcpy()** This function copies a string from one place to another. Use this function in preference to custom routines: it is set up to handle any peculiarities in the way data are stored. An example is

```
char *to,*from;

to = strcpy (to,from);
```

Where `to` is a pointer to the place to which the string is to be copied and `from` is the place where the string is to be copied from.

**strcmp()** This function compares two strings and returns a value which indicates how they compared. An example:

```
int value;
char *s1,*s2;

value = strcmp(s1,s2);
```

The value returned is 0 if the two strings were identical. If the strings were not the same, this function indicates the (ASCII) alphabetical order of the two. `s1 > s2`, alphabetically, then the

value is  $> 0$ . If  $s1 < s2$  then the value is  $< 0$ . Note that numbers come before letters in the ASCII code sequence and also that upper case comes before lower case.

**strstr()** Tests whether a substring is present in a larger string

```
int n;
char *s1,*s2;

if (n = strstr(s1,s2))
{
    printf("s2 is a substring of s1, starting at %d",n);
}
```

**strncpy()**

This function is like **strcpy**, but limits the copy to no more than **n** characters.

**strncmp()**

This function is like **strcmp**, but limits the comparison to no more than **n** characters.

More string functions are described in the next section along with a host of Standard Library Functions.

## 19.7 Example Listing

This program aims to get ten strings from the user. The strings may not contain any spaces or white space characters. It works as follows:

The user is prompted for a string which he/she types into a buffer. The length of the string is tested with **strlen()** and a block of memory is allocated for it using **malloc()**. (Notice that this block of memory is one byte longer than the value returned by **strlen()**, because **strlen()** does not count the end of string marker ‘\0’.) **malloc()** returns a pointer to the space allocated, which is then stored in the array called **array**. Finally the strings is copied from the buffer to the new storage with the library function **strcpy()**. This process is repeated for each of the 10 strings. Notice that the program exits through a low level function called **QuitSafely()**. The reason for doing this is to exit from the program neatly, while at the same time remembering to perform all a programmer’s duties, such as de-allocating the memory which is no longer needed. **QuitSafely()** uses the function **exit()** which should be provided as a standard library function. **exit()** allows a program to end at any point.

```
/*
 * String storage allocation
 */
*****
```

```

#include <stdio.h>

/* #include another file for malloc() and */
/* strlen() ????. Check the compiler manual! */

#define NOOFSTR 10
#define BUFSIZE 255
#define CODE 0

/*****
/* Level 0 */
*****/

main ()

{ char *array[NOOFSTR], *malloc();
  char buffer[BUFSIZE];
  int i;

  for (i = 0; i < NOOFSTR; i++)
  {
    printf ("Enter string %d :",i);
    scanf ("%255s",buffer);

    array[i] = malloc(strlen(buffer)+1);

    if (array[i] == NULL)
    {
      printf ("Can't allocate memory\n");
      QuitSafely (array);
    }

    strcpy (array[i],buffer);
  }

  for (i = 0; i < NOOFSTR; i++)
  {
    printf ("%s\n",array[i]);
  }

  QuitSafely(array);
}

/*****
/* Snakes & Ladders! */
*****/

QuitSafely (array) /* Quit & de-alloc memory */

char *array[NOOFSTR];

```

```

{ int i, len;

for (i = 0; i < NOOFSTR; i++)
{
    len = strlen(array[i]) + 1;
    if (free (array[i]) != 0)
    {
        printf ("Debug: free failed\n");
    }
}

exit (CODE);
}

/* end */

```

## 19.8 String Input/Output

Because strings are recognized to be special objects in C, some special library functions for reading and writing are provided for them. These make it easier to deal with strings, without the need for special user-routines. There are four of these functions:

```

gets()
puts()
sprintf()
sscanf()

```

### 19.8.1 gets()

This function fetches a string from the standard input file *stdin* and places it into some buffer which the programmer must provide.

```

#define SIZE    255

char *sptr, buffer[SIZE];

strptr = gets(buffer);

```

If the routine is successful in getting a string, it returns the value `buffer` to the string pointer `strptr`. Otherwise it returns `NULL` (`==0`). The advantage of `gets()` over `scanf("%s" ..)` is that it will read spaces in strings, whereas `scanf()` usually will not. `gets()` quits reading when it finds a newline character: that is, when the user presses *RETURN*.

NOTE: there are valid concerns about using this function. Often it is implemented as a macro with poor bounds checking and can be exploited



to produce memory corruption by system attackers. In order to write more secure code, use `fgets()` instead.

### 19.8.2 puts()

`puts()` sends a string to the output file `stdout`, until it finds a NULL end of string marker. The NULL byte is not written to `stdout`, instead a newline character is written.

```
char *string;
int returncode;

returncode = puts(string);
```

`puts()` returns an integer value, whose value is only guaranteed if there is an error. `returncode == EOF` if an end of file was encountered or there was an error.

### 19.8.3 sprintf()

This is an interesting function which works in almost the same way as `printf()`, the exception being that it prints to a string! In other words it treats a string as though it were an output file. This is useful for creating formatted strings in the memory. On most systems it works in the following way:

```
int n;
char *sp;

n = sprintf(sp, "control string", parameters, values);
```

`n` is an integer which is the number of characters printed. `sp` is a pointer to the destination string or the string which is to be written to. Note carefully that this function does not perform any check on the output string to make sure that it is long enough to contain the formatted output. If the string is not large enough, then a crash could be in store! This can also be considered a potential security problem, since buffer overflows can be used to capture control of important programs. Note that on system V Unix systems the `sprintf` function returns a pointer to the start of the printed string, breaking the pattern of the other `printf` functions. To make such an implementation compatible with the usual form you would have to write:

```
n = strlen(sprintf(parameters.....));
```

### 19.8.4 sscanf()

This function is the complement of `sprintf()`. It reads its input from a string, as though it were an input file.

```
int n;
```

```
char *sp;

n = sscanf (sp,"control string", pointers...);
```

`sp` is a pointer to the string which is to be read from. The string must be `NULL` terminated (it must have a zero-byte end marker `'\0'`). `sscanf()` returns an integer value which holds the number of items successfully matched or `EOF` if an end of file marker was read or an error occurred. The conversion specifiers are identical to those for `scanf()`.

## 19.9 Example Listing

```

/*****
/*                                     */
/* Formatted strings                  */
/*                                     */
*****/

/* program rewrites s1 in reverse into s2 */

#include <stdio.h>

#define SIZE 20
#define CODE 0

/*****

main ()

{ static char *s1 = "string 2.3 55x";
  static char *s2 = ".....";
  char ch, *string[SIZE];
  int i,n;
  float x;

  sscanf (s1,"%s %f %d %c", string, &x, &i, &ch);

  n = sprintf (s2,"%c %d %f %s", ch, i, x, string);

  if (n > SIZE)
  {
    printf ("Error: string overflowed!\n");
    exit (CODE);
  }

  puts (s2);
}

```

## 19.10 Questions

1. What are the two main ways of declaring strings in a program?
2. How would you declare a static array of strings?
3. Write a program which gets a number between 0 and 9 and prints out a different message for each number. Use a pre-initialized array to store the strings.



## 20 Putting together a program

*Putting it all together.*

### 20.1 The argument vector

C was written in order to implement Unix in a portable form. Unix was designed with a command language which was built up of independent programs. These could be passed arguments on the command line. For instance:

```
ls -l /etc

cc -o program prog.c
```

In these examples, the first word is the command itself, while the subsequent words are options and arguments to the command. We need some way getting this information into a C program. Unix solved this problem by passing C programs an array of these arguments together with their number as parameters to the function `main()`. Since then most other operating systems have adopted the same model, since it has become a part of the C language.

```
main (argc,argv)

int argc;
char *argv[];

{

}
```

The traditional names for the parameters are the argument count `argc` and the argument vector (array) `argv`. The operating system call which starts the C program breaks up the command line into an array, where the first element `argv[0]` is the name of the command itself and the last argument `argv[argc-1]` is the last argument. For example, in the case of

```
cc -o program prog.c
```

would result in the values

```
argv[0]  cc
argv[1]  -o
argv[2]  program
argv[3]  prog.c
```

The following program prints out the command line arguments:

```

main (argc,argv)

int argc;
char *argv[];

{ int i;

printf ("This program is called %s\n",argv[0]);

if (argc > 1)
{
for (i = 1; i < argc; i++)
{
printf("argv[%d] = %s\n",i,argv[i]);
}
}
else
{
printf("Command has no arguments\n");
}
}

```

## 20.2 Processing options

getopt

## 20.3 Environment variables

When we write a C program which reads command line arguments, they are fed to us by the argument vector. Unix processes also a set of text variable associations called environment variables. Each child process inherits the environment of its parent. The static environment variables are stored in a special array which is also passed to `main()` and can be read if desired.

```

main (argc,argv,envp)

int argc;
char *argv[], *envp[];

{

}

```

The array of strings '`envp[]`' is a list of values of the *environment variables* of the system, formatted by

```
NAME=value
```

This gives C programmers access to the shell's global environment.

In addition to the `'envp'` vector, it is possible to access the environment variables through the call `'getenv()'`. This is used as follows; suppose we want to access the shell environment variable `'$HOME'`.

```
char *string;
```

```
string = getenv("HOME");
```

`'string'` is now a pointer to static but public data. You should not use `'string'` as if it were your own property because it will be used again by the system. Copy its contents to another string before using the data.

```
char buffer[500];
```

```
strcpy (buffer,string);
```





## 21 Special Library Functions and Macros

*Checking character types. Handling strings. Doing maths.*

C provides a repertoire of standard library functions and macros for specialized purposes (and for the advanced user). These may be divided into various categories. For instance

- Character identification (`'ctype.h'`)
- String manipulation (`'string.h'`)
- Mathematical functions (`'math.h'`)

A program generally has to `#include` special header files in order to use special functions in libraries. The names of the appropriate files can be found in particular compiler manuals. In the examples above the names of the header files are given in parentheses.

### 21.1 Character Identification

Some or all of the following functions/macros will be available for identifying and classifying single characters. The programmer ought to beware that it would be natural for many of these facilities to exist as macros rather than functions, so the usual remarks about macro parameters apply. See Chapter 12 [Preprocessor], page 71. An example of their use is given above. Assume that `'true'` has any non-zero, integer value and that `'false'` has the integer value zero. `ch` stands for some character, or `char` type variable.

`isalpha(ch)`

This returns true if `ch` is alphabetic and false otherwise. Alphabetic means `a..z` or `A..Z`.

`isupper(ch)`

Returns true if the character was upper case. If `ch` was not an alphabetic character, this returns false.

`islower(ch)`

Returns true if the character was lower case. If `ch` was not an alphabetic character, this returns false.

`isdigit(ch)`

Returns true if the character was a digit in the range `0..9`.

`isxdigit(ch)`

Returns true if the character was a valid hexadecimal digit: that is, a number from `0..9` or a letter `a..f` or `A..F`.

`isspace(ch)`

Returns true if the character was a white space character, that is: a space, a *TAB* character or a newline.

`ispunct(ch)`  
Returns true if `ch` is a punctuation character.

`isalnum(ch)`  
Returns true if a character is alphanumeric: that is, alphabetic or digit.

`isprint(ch)`  
Returns true if the character is printable: that is, the character is not a control character.

`isgraph(ch)`  
Returns true if the character is graphic. i.e. if the character is printable (excluding the space)

`iscntrl(ch)`  
Returns true if the character is a control character. i.e. ASCII values 0 to 31 and 127.

`isascii(ch)`  
Returns true if the character is a valid ASCII character: that is, it has a code in the range 0..127.

`iscsym(ch)`  
Returns true if the character was a character which could be used in a C identifier.

`toupper(ch)`  
This converts the character `ch` into its upper case counterpart. This does not affect characters which are already upper case, or characters which do not have a particular case, such as digits.

`tolower(ch)`  
This converts a character into its lower case counterpart. It does not affect characters which are already lower case.

`toascii(ch)`  
This strips off bit 7 of a character so that it is in the range 0..127: that is, a valid ASCII character.

## 21.2 Examples

```

/*****
/*
/* Demonstration of character utility functions
/*
/*
/*****

/* prints out all the ASCII characters which give */
/* the value "true" for the listed character fns */

```

```
#include <stdio.h>
#include <ctype.h> /* contains character utilities */

#define ALLCHARS ch = 0; isascii(ch); ch++

/*****

main () /* A criminally long main program! */
{ char ch;

printf ("VALID CHARACTERS FROM isalpha()\n\n");

for (ALLCHARS)
{
if (isalpha(ch))
{
printf ("%c ",ch);
}
}

printf ("\n\nVALID CHARACTERS FROM isupper()\n\n");

for (ALLCHARS)
{
if (isupper(ch))
{
printf ("%c ",ch);
}
}

printf ("\n\nVALID CHARACTERS FROM islower()\n\n");

for (ALLCHARS)
{
if (islower(ch))
{
printf ("%c ",ch);
}
}

printf ("\n\nVALID CHARACTERS FROM isdigit()\n\n");

for (ALLCHARS)
{
if (isdigit(ch))
{
printf ("%c ",ch);
}
}

printf ("\n\nVALID CHARACTERS FROM isxdigit()\n\n");
```

```

for (ALLCHARS)
{
    if (isxdigit(ch))
    {
        printf ("%c ",ch);
    }
}

printf ("\n\nVALID CHARACTERS FROM ispunct()\n\n");

for (ALLCHARS)
{
    if (ispunct(ch))
    {
        printf ("%c ",ch);
    }
}

printf ("\n\nVALID CHARACTERS FROM isalnum()\n\n");

for (ALLCHARS)
{
    if (isalnum(ch))
    {
        printf ("%c ",ch);
    }
}

printf ("\n\nVALID CHARACTERS FROM iscsym()\n\n");

for (ALLCHARS)
{
    if (iscsym(ch))
    {
        printf ("%c ",ch);
    }
}
}

```

## 21.3 Program Output

VALID CHARACTERS FROM isalpha()

A B C D E F G H I J K L M N O P Q R S T U V W X Y Z a b c d e f g h i j  
k l m n o p q r s t u v w x y z

VALID CHARACTERS FROM isupper()

A B C D E F G H I J K L M N O P Q R S T U V W X Y Z

```

VALID CHARACTERS FROM islower()

a b c d e f g h i j k l m n o p q r s t u v w x y z

VALID CHARACTERS FROM isdigit()

0 1 2 3 4 5 6 7 8 9

VALID CHARACTERS FROM isxdigit()

0 1 2 3 4 5 6 7 8 9 A B C D E F a b c d e f

VALID CHARACTERS FROM ispunct()

! " # $ % & ' ( ) * + , - . / : ; < = > ? @ [ \ ] ^ _ ` { | } ~

VALID CHARACTERS FROM isalnum()

0 1 2 3 4 5 6 7 8 9 A B C D E F G H I J K L M N O P Q R S T U V W
X Y Z a b c d e f g h i j k l m n o p q r s t u v w x y z

VALID CHARACTERS FROM iscsym()

0 1 2 3 4 5 6 7 8 9 A B C D E F G H I J K L M N O P Q R S T U V W
X Y Z _ a b c d e f g h i j k l m n o p q r s t u v w x y z

```

## 21.4 String Manipulation

The following functions perform useful functions for string handling, See [\[Strings\]](#), page [\[undefined\]](#).

**strcat()** This function "concatenates" two strings: that is, it joins them together into one string. The effect of:

```

char *new,*this, onto[255];

new = strcat(onto,this);

```

is to join the string **this** onto the string **onto**. **new** is a pointer to the complete string; it is identical to **onto**. Memory is assumed to have been allocated for the starting strings. The string which is to be copied to must be large enough to accept the new string, tagged onto the end. If it is not then unpredictable effects will result. (In some programs the user might get away without declaring enough space for the "onto" string, but in general the results will be garbage, or even a crashed machine.) To join two static strings together, the following code is required:

```

char *s1 = "string one";
char *s2 = "string two";

```

```

main ()
{
    char buffer[255];

    strcat(buffer,s1);
    strcat(buffer,s2);
}

```

buffer would then contain "string onestring two".

**strlen()** This function returns a type int value, which gives the length or number of characters in a string, not including the NULL byte end marker. An example is:

```

int len;
char *string;
len = strlen (string);

```

**strcpy()** This function copies a string from one place to another. Use this function in preference to custom routines: it is set up to handle any peculiarities in the way data are stored. An example is

```

char *to,*from;

to = strcpy (to,from);

```

Where **to** is a pointer to the place to which the string is to be copied and **from** is the place where the string is to be copied from.

**strcmp()** This function compares two strings and returns a value which indicates how they compared. An example:

```

int value;
char *s1,*s2;

value = strcmp(s1,s2);

```

The value returned is 0 if the two strings were identical. If the strings were not the same, this function indicates the (ASCII) alphabetical order of the two. **s1 > s2**, alphabetically, then the value is '> 0'. If **s1 < s2** then the value is < 0. Note that numbers come before letters in the ASCII code sequence and also that upper case comes before lower case.

There are also variations on the theme of the functions above which begin with '**strn**' instead of '**str**'. These enable the programmer to perform the same actions with the first **n** characters of a string:

`strncat()` This function *concatenates* two strings by copying the first `n` characters of `this` to the end of the `onto` string.

```
char *onto,*new,*this;

new = strncat(onto,this,n);
```

`strncpy()` This function copies the first `n` characters of a string from one place to another

```
char *to,*from;
int n;

to = strncpy (to,from,n);
```

`strncmp()` This function compares the first `n` characters of two strings

```
int value;
char *s1,*s2;

value = strcmp(s1,s2,n);
```

The following functions perform conversions between strings and floating point/integer types, without needing to use `sscanf()`. They take a pre-initialized string and work out the value represented by that string.

`atof()` ASCII to floating point conversion.

```
double x;
char *stringptr;

x = atof(stringptr);
```

`atoi()` ASCII to integer conversion.

```
int i;
char *stringptr;

i = atoi(stringptr);
```

`atol()` ASCII to long integer conversion.

```
long i;
char *stringptr;

i = atol(stringptr);
```

## 21.5 Examples

```

/*****
/*
/* String comparison
/*
/*
*****/

#include <stdio.h>

#define TRUE 1
#define MAXLEN 30

/*****

main ()

{ char string1[MAXLEN],string2[MAXLEN];
  int result;

while (TRUE)
  {
  printf ("Type in string 1:\n\n");
  scanf ("%30s",string1);

  printf ("Type in string 2:\n\n");
  scanf ("%30s",string2);

  result = strcmp (string1,string2);

  if (result == 0)
    {
    printf ("Those strings were the same!\n");
    }

  if (result > 0)
    {
    printf ("string1 > string2\n");
    }

  if (result < 0)
    {
    printf ("string1 < string 2\n");
    }
  }
}

```

## 21.6 Mathematical Functions

C has a library of standard mathematical functions which can be accessed by #including the appropriate header files ('math.h' etc.). It should be noted



that all of these functions work with `double` or `long float` type variables. All of C's mathematical capabilities are written for long variable types. Here is a list of the functions which can be expected in the standard library file. The variables used are all to be declared `long`

```
int i;                /* long int */
double x,y,result;   /* long float */
```

The functions themselves must be declared long float or double (which might be done automatically in the mathematics library file, or in a separate file) and any constants must be written in floating point form: for instance, write '7.0' instead of just '7'.

**ABS()**      MACRO. Returns the unsigned value of the value in parentheses. See **fabs()** for a function version.

**fabs()**      Find the absolute or unsigned value of the value in parentheses:

```
result = fabs(x);
```

**ceil()**      Find out what the ceiling integer is: that is, the integer which is just above the value in parentheses. This is like rounding up.

```
i = ceil(x);
/* ceil (2.2) is 3 */
```

**floor()**     Find out what the floor integer is: that is, the integer which is just below the floating point value in parentheses

```
i = floor(x);
/* floor(2.2) is 2 */
```

**exp()**      Find the exponential value.

```
result = exp(x);
result = exp(2.7);
```

**log()**      Find the natural (Naperian) logarithm. The value used in the parentheses must be unsigned: that is, it must be greater than zero. It does not have to be declared specifically as unsigned. e.g.

```
result = log(x);
result = log(2.71828);
```

`log10()` Find the base 10 logarithm. The value used in the parentheses must be unsigned: that is, it must be greater than zero. It does not have to be declared specifically as unsigned.

```
result = log10(x);
result = log10(10000);
```

`pow()` Raise a number to the power.

```
result = pow(x,y); /*raise x to the power y */
result = pow(x,2); /*find x-squared */

result = pow(2.0,3.2); /* find 2 to the power 3.2 ...*/
```

`sqrt()` Find the square root of a number.

```
result = sqrt(x);
result = sqrt(2.0);
```

`sin()` Find the sine of the angle in radians.

```
result = sin(x);
result = sin(3.14);
```

`cos()` Find the cosine of the angle in radians.

```
result = cos(x);
result = cos(3.14);
```

`tan()` Find the tangent of the angle in radians.

```
result = tan(x);
result = tan(3.14);
```

`asin()` Find the arcsine or inverse sine of the value which must lie between +1.0 and -1.0.

```
result = asin(x);
result = asin(1.0);
```

`acos()` Find the arccosine or inverse cosine of the value which must lie between +1.0 and -1.0.

```
result = acos(x);
result = acos(1.0);
```

`atan()` Find the arctangent or inverse tangent of the value.

```

result = atan(x);
result = atan(200.0);

```

`atan2()` This is a special inverse tangent function for calculating the inverse tangent of  $x$  divided by  $y$ . This function is set up to find this result more accurately than `atan()`.

```

result = atan2(x,y);
result = atan2(x/3.14);

```

`sinh()` Find the hyperbolic sine of the value. (Pronounced "shine" or "sinch")

```

result = sinh(x);
result = sinh(5.0);

```

`cosh()` Find the hyperbolic cosine of the value.

```

result = cosh(x);
result = cosh(5.0);

```

`tanh()` Find the hyperbolic tangent of the value.

```

result = tanh(x);
result = tanh(5.0);

```

## 21.7 Examples

```

/*****
/*
/* Maths functions demo #1
/*
/*****

/* use sin(x) to work out an animated model */

#include <stdio.h>
#include <math.h>
#include <limits.h>

#define TRUE      1
#define AMPLITUDE 30
#define INC       0.02

double pi;          /* this may already be defined */
                    /* in the math file */

```

```

/*****
/* Level 0
*****/

main ()          /* The simple pendulum program */

{ pi = asin(1.0)*2;    /* if PI is not defined */

printf ("\nTHE SIMPLE PENDULUM:\n\n\n");

Pendulum();
}

/*****
/* Level 1
*****/

Pendulum ()

{ double x, twopi = pi * 2;
  int i,position;

while (true)
  {
  for (x = 0; x < twopi; x += INC)
    {
    position = (int)(AMPLITUDE * sin(x));

    for (i = -AMPLITUDE; i <= AMPLITUDE; i++)
      {
      if (i == position)
        {
        putchar('*');
        }
      else
        {
        putchar(' ');
        }
      }
    startofline();
    }
  }
}

/*****
/* Toolkit
*****/

startofline()

{

```

```
    putchar('\r');
}
```

## 21.8 Maths Errors

Mathematical functions can be delicate animals. There exist mathematical functions which simply cannot produce sensible answers in all possible cases. Mathematical functions are not "user friendly"! One example of an unfriendly function is the inverse sine function `asin(x)` which only works for values of `x` in the range `+1.0` to `-1.0`. The reason for this is a mathematical one: namely that the sine function (of which `asin()` is the opposite) only has values in this range. The statement

```
y = asin (25.3);
```

is nonsense and it cannot possibly produce a value for `y`, because none exists. Similarly, there is no simple number which is the square root of a negative value, so an expression such as:

```
x = sqrt(-2.0);
```

would also be nonsense. This doesn't stop the programmer from writing these statements though and it doesn't stop a faulty program from straying out of bounds. What happens then when an erroneous statement is executed? Some sort of error condition would certainly have to result.

In many languages, errors, like the ones above, are terminal: they cause a program to stop without any option to recover the damage. In C, as the reader might have come to expect, this is not the case. It is possible (in principle) to recover from any error, whilst still maintaining firm control of a program.

Errors like the ones above are called domain errors (the set of values which a function can accept is called the domain of the function). There are other errors which can occur too. For example, division by zero is illegal, because dividing by zero is "mathematical nonsense" – it can be done, but the answer can be all the numbers which exist at the same time! Obviously a program cannot work with any idea as vague as this. Finally, in addition to these "pathological" cases, mathematical operations can fail just because the numbers they deal with get too large for the computer to handle, or too small, as the case may be.

*Domain error*

Illegal value put into function

*Division by zero*

Dividing by zero is nonsense.

*Overflow* Number became too large

*Underflow* Number became too small.



```

#include <stdio.h>
#include <math.h>
#include <limits.h>

#define LIMIT 5

double inc = 0.001;      /* Increment width - arbitrary */
double twopi;

/*****
** LEVEL 0
**
*****/

main ()

{ double y,integrand();
  double integral = 0;
  twopi = 4 * asin(1.0);

for ( y = inc/2; y < LIMIT; y += inc )
  {
  integral += integrand (y) * inc;
  }

printf ("Integral value = %.10f \n",integral);
}

/*****
** LEVEL 1
**
*****/

double integrand (y)

double y;

{ double value;

value = 2*y;

if (value > 1e308)
  {
  printf ("Overflow error\n");
  exit (0);
  }

return (value);
}

```

## 21.10 Questions

1. What type of data is returned from mathematical functions?

2. All calculations are performed using long variables. True or false?
3. What information is returned by `strlen()`?
4. What action is performed by `strcat()`?
5. Name five kinds of error which can occur in a mathematical function.



## 22 Hidden operators and values

### *Concise expressions*

Many operators in C are more versatile than they appear to be, at first glance. Take, for example, the following operators

```
=    ++    --    +=    -=    etc...
```

the assignment, increment and decrement operators... These innocent looking operators can be used in some surprising ways which make C source code very neat and compact.

The first thing to notice is that ++ and -- are unary operators: that is, they are applied to a single variable and they affect that variable alone. They therefore produce one unique value each time they are used. The assignment operator, on the other hand, has the unusual position of being both unary, in the sense that it works out only one expression, and also binary or dyadic because it sits between two separate objects: an "lvalue" on the left hand side and an expression on the right hand side. Both kinds of operator have one thing in common however: both form statements which have values in their own right. What does this mean? It means that certain kinds of statement, in C, do not have to be thought of as being complete and sealed off from the rest of a program. To paraphrase a famous author: "In C, no statement is an island". A statement can be taken as a whole (as a "black box") and can be treated as a single value, which can be assigned and compared to things! The value of a statement is the result of the operation which was carried out in the statement.

Increment/decrement operator statements, taken as a whole, have a value which is one greater / or one less than the value of the variable which they act upon. So:

```
c = 5;
c++;
```

The second of these statement 'c++;' has the value 6, and similarly:

```
c = 5;
c--;
```

The second of these statements 'c--;' has the value 4. Entire assignment statements have values too. A statement such as:

```
c = 5;
```

has the value which is the value of the assignment. So the example above has the value 5. This has some important implications.

## 22.1 Extended and Hidden =

The idea that assignment statement has a value, can be used to make C programs neat and tidy for one simple reason: it means that a whole assignment statement can be used in place of a value. For instance, the value 'c = 0;' could be assigned to a variable b:

```
b = (c = 0);
```

or simply:

```
b = c = 0;
```

These equivalent statements set b and c to the value zero, provided b and c are of the same type! It is equivalent to the more usual:

```
b = 0;
c = 0;
```

Indeed, any number of these assignments can be strung together:

```
a = (b = (c = (d = (e = 5))))
```

or simply:

```
a = b = c = d = e = 5;
```

This very neat syntax compresses five lines of code into one single line! There are other uses for the valued assignment statement, of course: it can be used anywhere where a value can be used. For instance:

- In other assignments (as above)
- As a parameter for functions
- Inside a comparison (== > < etc..)
- As an index for arrays...

The uses are manifold. Consider how an assignment statement might be used as a parameter to a function. The function below gets a character from the input stream `stdin` and passes it to a function called `ProcessCharacter()`:

```
ProcessCharacter (ch = getchar());
```

This is a perfectly valid statement in C, because the hidden assignment statement passes on the value which it assigns. The actual order of events is that the assignment is carried out first and then the function is called. It would not make sense the other way around, because, then there would be

no value to pass on as a parameter. So, in fact, this is a more compact way of writing:

```
ch = getchar();
ProcessCharacter (ch);
```

The two methods are entirely equivalent. If there is any doubt, examine a little more of this imaginary character processing program:

```
ProcessCharacter(ch = getchar());

if (ch == '*')
{
    printf ("Starry, Starry Night...");
}
```

The purpose in adding the second statement is to impress the fact that `ch` has been assigned quite legitimately and it is still defined in the next statement and the one after...until it is re-assigned by a new assignment statement. The fact that the assignment was hidden inside another statement does not make it any less valid. All the same remarks apply about the specialized assignment operators `+=`, `*=`, `/=` etc..

## 22.2 Example

```

/*****
/*                                     */
/* Hidden Assignment #1                */
/*                                     */
/*****

main ()

{
do
{
    switch (ch = getchar())
    {
        default : putchar(ch);
                break;
        case 'Q' : /* Quit */
    }
}
while (ch != 'Q');
}

    /* end */

```

```

/*****
/*
/* Hidden Assignment #2
/*
/*****

main ()

{ double x = 0;

while ((x += 0.2) < 20.0)
  {
  printf ("%lf",x);
  }
}

      /* end */

```

### 22.3 Hidden ++ and --

The increment and decrement operators also form statements which have intrinsic values and, like assignment expressions, they can be hidden away in inconspicuous places. These two operators are slightly more complicated than assignments because they exist in two forms: as a postfix and as a prefix:

<i>Postfix</i>	<i>Prefix</i>
var++	++var
var--	--var

and these two forms have subtly different meanings. Look at the following example:

```

int i = 3;

PrintNumber (i++);

```

The increment operator is hidden in the parameter list of the function `PrintNumber()`. This example is not as clear cut as the assignment statement examples however, because the variable `i` has, both a value before the `++` operator acts upon it, and a different value afterwards. The question is then: which value is passed to the function? Is `i` incremented before or after the function is called? The answer is that this is where the two forms of the operator come into play.

**If the operator is used as a prefix, the operation is performed *before* the function call. If the operator is used as a postfix, the operation is performed *after* the function call.**

In the example above, then, the value 3 is passed to the function and when the function returns, the value of `i` is incremented to 4. The alternative is to write:

```
int i = 3;

PrintNumber (++i);
```

in which case the value 4 is passed to the function `PrintNumber()`. The same remarks apply to the decrement operator.

## 22.4 Arrays, Strings and Hidden Operators

Arrays and strings are one area of programming in which the increment and decrement operators are used a lot. Hiding operators inside array subscripts or hiding assignments inside loops can often make light work of tasks such as initialization of arrays. Consider the following example of a one dimensional array of integers.

```
#define SIZE 20

int i, array[SIZE];

for (i = 0; i < SIZE; array[i++] = 0)
{
}
```

This is a neat way of initializing an array to zero. Notice that the postfix form of the increment operator is used. This prevents the element `array[0]` from assigning zero to memory which is out of the bounds of the array.

Strings too can benefit from hidden operators. If the standard library function `strlen()` (which finds the length of a string) were not available, then it would be a simple matter to write the function

```
strlen (string) /* count the characters in a string */

char *string;

{ char *ptr;
  int count = 0;

  for (ptr = string; *(ptr++) != '\0'; count++)
  {
  }

  return (count);
}
```



```

printf ("%d",Value());
}

/*****

Value()                /* Check for zero .... */

{ int value;

if ((value = GetValue()) == 0)
  {
  printf ("Value was zero\n");
  }

return (value);
}

/*****

GetValue()            /* Some function to get a value */

{
return (0);
}

/* end */

```

## 22.6 Cautions about Style

Hiding operators away inside other statements can certainly make programs look very elegant and compact, but, as with all neat tricks, it can make programs harder to understand. Never forget that programming is communication to other programmers and be kind to the potential reader of a program. (It could be you in years or months to come!) Statements such as:

```

if ((i = (int)ch++) <= --comparison)
  {
  }

```

are not recommendable programming style and they are no more efficient than the more longwinded:

```

ch++;
i = (int)ch;

if (i <= comparison)
  {
  }

comparison--;

```

There is always a happy medium in which to settle on a readable version of the code. The statement above might perhaps be written as:

```
i = (int) ch++;

if (i <= --comparison)
{
}
```

## 22.7 Example

```

/*****
/*
/* Arrays and Hidden Operators
/*
/*
*****/

#include <stdio.h>

#define SIZE 10

/*****
/* Level 0
*****/

main () /* Demo prefix and postfix ++ in arrays */

{ int i, array[SIZE];

Initialize(array);
i = 4;
array[i++] = 8;
Print (array);

Initialize(array);
i = 4;
array[++i] = 8;
Print(array);
}

/*****
/* Level 1
*****/

Initialize (array) /* set to zero */

int array[SIZE];

{ int i;
```



```

for (i = 0; i < SIZE; array[i++] = 0)
    {
    }
}

/*****

Print (array)                /* to stdout */

int array[SIZE];

{ int i = 0;

while (i < SIZE)
    {
    printf ("%2d",array[i++]);
    }

putchar ('\n');
}

        /* end */

/*****
/*
/* Hidden Operator
/*
/*
/*****/

#include <stdio.h>

#define MAXNO 20

/*****/

main ()                /* Print out 5 x table */

{ int i, ctr = 0;

for (i = 1; ++ctr <= MAXNO; i = ctr*5)
    {
    printf ("%3d",i);
    }
}

```

## 22.8 Questions

1. Which operators can be hidden inside other statements?
2. Give a reason why you would not want to do this in every possible case.

3. Hidden operators can be used in return statements .e.g

```
return (++x);
```

Would there be any point in writing:

```
return (x++);
```

## 23 More on data types

This section is about the remaining data types which C has to offer programmers. Since C allows you to define new data types we shall not be able to cover all of the possibilities, only the most important examples. The most important of these are

<code>FILE</code>	The type which files are classified under
<code>enum</code>	Enumerated type for abstract data
<code>void</code>	The "empty" type
<code>volatile</code>	New ANSI standard type for memory mapped I/O
<code>const</code>	New ANSI standard type for fixed data
<code>struct</code>	Groups of variables under a single name
<code>union</code>	Multi-purpose storage areas for dynamical memory allocation

### 23.1 Special Constant Expressions

Constant expressions are often used without any thought, until a programmer needs to know how to do something special with them. It is worth making a brief remark about some special ways of writing integer constants, for the latter half of this book.

Up to now the distinction between long and short integer types has largely been ignored. Constant values can be declared explicitly as long values, in fact, by placing the letter L after the constant.

```
long int variable = 23L;

variable = 236526598L;
```

Advanced programmers, writing systems software, often find it convenient to work with hexadecimal or octal numbers since these number bases have a special relationship to binary. A constant in one of these types is declared by placing either '0' (zero) or '0x' in front of the appropriate value. If *ddd* is a value, then:

Octal number	<code>0ddd</code>
Hexadecimal number	<code>0xddd</code>

For example:

```
oct_value = 077;          /* 77 octal */

hex_value = 0xFFEF;      /* FFEF hex */
```

This kind of notation has already been applied to strings and single character constants with the backslash notation, instead of the leading zero character:

```
ch = '\ddd';
ch = '\xdd';
```

The values of character constants, like these, cannot be any greater than 255.

## 23.2 FILE

In all previous sections, the files `stdin`, `stdout` and `stderr` alone have been used in programs. These special files are always handled implicitly by functions like `printf()` and `scanf()`: the programmer never gets to know that they are, in fact, files. Programs do not have to use these functions however: standard input/output files can be treated explicitly by general file handling functions just as well. Files are distinguished by filenames and by file pointers. File pointers are variables which pass the location of files to file handling functions; being variables, they have to be declared as being some data type. That type is called `FILE` and file pointers have to be declared "pointer to `FILE`". For example:

```
FILE *fp;

FILE *fp = stdin;

FILE *fopen();
```

File handling functions which return file pointers must also be declared as pointers to files. Notice that, in contrast to all the other reserved words `FILE` is written in upper case: the reason for this is that `FILE` is not a simple data type such as `char` or `int`, but a *structure* which is only defined by the header file `'stdio.h'` and so, strictly speaking, it is not a reserved word itself. We shall return to look more closely at files soon.

## 23.3 enum

Abstract data are usually the realm of exclusively high level languages such as Pascal. `enum` is a way of incorporating limited "high level" data facilities into C.

`enum` is short for enumerated data. The user defines a type of data which is made up of a fixed set of words, instead of numbers or characters. These words are given substitute integer numbers by the compiler which are used to identify and compare `enum` type data. For example:

```
enum countries
{
    England,
    Scotland,
```

```

    Wales,
    Eire,
    Norge,
    Sverige,
    Danmark,
    Deutschland
};

main ()

{ enum countries variable;

  variable = England;
}

```

Why go to all this trouble? The point about enumerated data is that they allow the programmer to forget about any numbers which the computer might need in order to deal with a list of words, like the ones above, and simply concentrate on the logic of using them. Enumerated data are called abstract because the low level number form of the words is removed from the users attention. In fact, enumerated data are made up of integer constants, which the compiler generates itself. For this reason, they have a natural partner in programs: the switch statement. Here is an example, which uses the countries above to make a kind of airport "help computer" in age of electronic passports!

## 23.4 Example

```

/*****/
/*                                     */
/* Enumerated Data                     */
/*                                     */
/*****/

#include <stdio.h>

enum countries

{
  England,
  Ireland,
  Scotland,
  Wales,
  Danmark,
  Island,
  Norge,
  Sverige
};

```

```

/*****/

main ()          /* Electronic Passport Program */

{ enum countries birthplace, getinfo();

printf ("Insert electronic passport\n");
birthplace = getinfo();

switch (birthplace)
{
case England : printf ("Welcome home!\n");
break;
case Danmark :
case Norge   : printf ("Velkommen til England\n");
break;
}
}

/*****/

enum countries getinfo()      /* interrogate passport */

{
return (England);
}

/* end */

```

`enum` makes words into constant integer values for a programmer. Data which are declared `enum` are not the kind of data which it makes sense to do arithmetic with (even integer arithmetic), so in most cases it should not be necessary to know or even care about what numbers the compiler gives to the words in the list. However, some compilers allow the programmer to force particular values on words. The compiler then tries to give the values successive integer numbers unless the programmer states otherwise. For instance:

```

enum planets
{
Mercury,
Venus,
Earth = 12,
Mars,
Jupiter,
Saturn,
Uranus,
Neptune,
Pluto
};

```

This would probably yield values Mercury = 0, Venus = 1, Earth = 12, Mars = 13, Jupiter = 14 ... etc. If the user tries to force a value which the compiler has already used then the compiler will complain.

The following example program listing shows two points:

- enum types can be local or global.
- The labels can be forced to have certain values

## 23.5 Example

```

/*****
/*
/* Enumerated Data
/*
/*****

/* The smallest adventure game in the world */

#include <stdio.h>

#define TRUE 1
#define FALSE 0

enum treasures /* Adventure Treasures */
{
    rubies,
    sapphires,
    gold,
    silver,
    mask,
    scroll,
    lamp
};

/*****
/* Level 0
/*****

main () /* Tiny Adventure! */

{ enum treasures object = gold;

if (getobject(object))
{
    printf ("Congratulations you've found the gold!\n");
}
else
{
    printf ("Too bad -- you just missed your big chance");
}
}

```

```

/*****
/* Level 1 */
*****/

getobject (ob)                /* yes or no ? */

enum treasures ob;

{ enum answer
  {
    no = false,
    yes = true
  };

if (ob == gold)
  {
  printf ("Pick up object? Y/N\n");

  switch (getchar())
    {
    case 'y' :
    case 'Y' : return ((int) yes);    /* true and false */
    default  : return ((int) no);    /* are integers */
    }
  }
else
  {
  printf ("You grapple with the dirt\n");
  return (false);
  }
}

/* end */

```

## 23.6 Suggested uses for enum

Here are some suggested uses for enum.

```

enum numbers
{
  zero,
  one,
  two,
  three
};

enum animals
{
  cat,
  dog,

```



```
    cow,  
    sheep,  
};  
  
enum plants  
{  
    grass,  
    roses,  
    cabbages,  
    oaktree  
};  
  
enum diseases  
{  
    heart,  
    skin,  
    malnutrition,  
    circulatory  
};  
  
enum quarks  
{  
    up,  
    down,  
    charmed,  
    strange,  
    top,  
    bottom,  
    truth,  
    beauty  
};
```

Other suggestions: colours, names of roads or types of train.

## 23.7 void

`void` is a peculiar data type which has some debatable uses. The `void` datatype was introduced in order to make C syntactically consistent. The main idea of `void` is to be able to declare functions which have no return value. The word ‘void’ is intended in the meaning ‘empty’ rather than ‘invalid’. If you recall, the default is for C functions to return a value of type `int`. The value returned by a function did not *have* to be specified could always be discarded, so this was not a problem in practice. It did make compiler checks more difficult however: how do you warn someone about inconsistent return values if it is legal to ignore return values?

The ANSI solution was to introduce a new data type which was called `void` for functions with no value. The word `void` is perhaps an unfortunate choice, since it has several implicit meanings none of which really express what is intended. The words ‘novalue’ or ‘notype’ would have been better choices. A variable or function can be declared `void` in the following ways.

```
void function();
void variable;
void *ptr;

(void) returnvalue();
```

The following are true of `void`:

- A variable which is declared `void` is useless: it cannot be used in an expression and it cannot be assigned to a value. The data type was introduced with functions in mind but the grammar of C allows us to define variables of this type also, even though there is no point.
- A function which is declared `void` has no return value and returns simply with:

```
return;
```

- A function call can be cast (`void`) in order to explicitly discard a return value (though this is done by the compiler anyway). For instance, `scanf()` returns the number of items it matches in the control string, but this is usually discarded.

```
scanf ("%c",&ch);
```

or

```
(void) scanf("%c",&ch);
```

Few programmers would do this since it merely clutters up programs with irrelevant verbiage.

- A `void` pointer can point to to any kind of object. This means that any pointer can be assigned to a `void` pointer, regardless of its type. This is also a highly questionable feature of the ANSI draft. It replaces the meaning of `void` from 'no type or value' to 'no particular type'. It allows assignments between incompatible pointer types without a cast operator. This is also rather dubious.

## 23.8 volatile

`volatile` is a type which has been proposed in the ANSI standard. The idea behind this type is to allow memory mapped input/output to be held in C variables. Variables which are declared `volatile` will be able to have their values altered in ways which a program does not explicitly define: that is, by external influences such as clocks, external ports, hardware, interrupts etc...

The `volatile` datatype has found another use since the arrival of multiprocessor, multithreaded operating systems. Independent processes which

share common memory could each change a variable independently. In other words, in a multithreaded environment the value of a variable set by one process in shared memory might be altered by another process without its knowledge. The keyword `volatile` servers as a warning to the compiler that any optimizing code it produces should not rely on caching the value of the variable, it should always reread its value.

## 23.9 const

The reserved word `const` is used to declare data which can only be assigned once, either because they are in ROM (for example) or because they are data whose values must not be corrupted. Types declared `const` must be assigned when they are first initialized and they exist as stored values only at compile time:

```
const double pi = 3.14;
const int one = 1;
```

Since a constant array only exists at compile time, it can be initialized by the compiler.

```
const int array[] =
{
    1,
    2,
    3,
    4
};
```

`array[0]` then has the value 1, `array[1]` has the value 2 ... and so on. Any attempt to assign values to `const` types will result in compilation errors.

It is worth comparing the `const` declaration to enumerated data, since they are connected in a very simple way. The following two sets of statements are the same:

```
enum numbers
{
    zero,
    one,
    two,
    three,
    four
};
```

and

```
const zero = 0;
const one = 1;
const two = 2;
const three = 3;
```

```
const four = 4;
```

Constant types and enumerated data are therefore just different aspects of the same thing. Enumerated data provide a convenient way of classifying constants, however, while the compiler keeps track of the values and types. With `const` you have to keep track of constant values personally.

## 23.10 struct

Structures are called records in Pascal and many other languages. They are packages of variables which are all wrapped up under a single name. Structures are described in detail in chapter 25.

## 23.11 union

Unions are often grouped together with structures, but they are quite unlike them in almost all respects. They are like general purpose storage containers, which can hold a variety of different variable types, at different times. The compiler makes a container which is large enough to take any of these, See [\[Structures and Unions\]](#), page [\[Structures and Unions\]](#).

## 23.12 typedef

C allows us to define our own data types or to rename existing ones by using a compiler directive called `typedef`. This statement is used as follows:

```
typedef type newtypename;
```

So, for example, we could define a type called `byte`, which was exactly one byte in size by redefining the word `char`:

```
typedef unsigned char byte;
```

The compiler type checking facilities then treat `byte` as a new type which can be used to declare variables:

```
byte variable, function();
```

The `typedef` statement may be written inside functions or in the global white space of a program.

```

/*****
/* Program */
*****/

typedef int newname1;

main ()

```

```
{
typedef char newname2;
}
```

This program will compile and run (though it will not do very much).

It is not very often that you want to rename existing types in the way shown above. The most important use for typedef is in conjunction with structures and unions. Structures and unions can, by their very definition, be all kinds of shape and size and their names can become long and tedious to declare. typedef makes dealing with these simple because it means that the user can define a structure or union with a simple typename.

### 23.13 Questions

1. Is `FILE` a reserved word? If so why is it in upper case?
2. Write a statement which declares a file pointer called `fp`.
3. Enumerated data are given values by the compiler so that it can do arithmetic with them. True or false?
4. Does `void` do anything which C cannot already do without this type?
5. What type might a timer device be declared if it were to be called by a variable name?
6. Write a statement which declares a new type "real" to be like the usual type "double".
7. Variables declared `const` can be of any type. True or false?



## 24 Machine Level Operations

*Bits and Bytes. Flags/messages. Shifting.*

Down in the depths of your computer, below even the operating system are bits of memory. These days we are used to working at such a high level that it is easy to forget them. Bits (or binary digits) are the lowest level software objects in a computer: there is nothing more primitive. For precisely this reason, it is rare for high level languages to even acknowledge the existence of bits, let alone manipulate them. Manipulating bit patterns is usually the preserve of assembly language programmers. C, however, is quite different from most other high level languages in that it allows a programmer full access to bits and even provides high level operators for manipulating them.

Since this book is an introductory text, we shall treat bit operations only superficially. Many of the facilities which are available for bit operations need not concern the majority of programs at all. This section concerns the main uses of bit operations for high level programs and it assumes a certain amount of knowledge about programming at the low level. You may wish to consult a book on assembly language programming to learn about low level memory operations, in more detail.

### 24.1 Bit Patterns

All computer data, of any type, are bit patterns. The only difference between a string and a floating point variable is the way in which we choose to interpret the patterns of bits in a computer's memory. For the most part, it is quite unnecessary to think of computer data as bit patterns; systems programmers, on the other hand, frequently find that they need to handle bits directly in order to make efficient use of memory when using flags. A flag is a message which is either one thing or the other: in system terms, the flag is said to be 'on' or 'off' or alternatively *set* or *cleared*. The usual place to find flags is in a status register of a CPU (central processor unit) or in a pseudo-register (this is a status register for an imaginary processor, which is held in memory). A status register is a group of bits (a byte perhaps) in which each bit signifies something special. In an ordinary byte of data, bits are grouped together and are interpreted to have a collective meaning; in a status register they are thought of as being independent. Programmers are interested to know about the contents of bits in these registers, perhaps to find out what happened in a program after some special operation is carried out. Other uses for bit patterns are listed below here:

- Messages sent between devices in a complex operating environment use bits for efficiency.
- Serially transmitted data.

- Handling bit-planes in screen memory. (Raster ports and devices)
- Performing fast arithmetic in simple cases.

Programmers who are interested in performing bit operations often work in hexadecimal because every hexadecimal digit conveniently handles four bits in one go (16 is 2 to the power 4).

## 24.2 Flags, Registers and Messages

A *register* is a place inside a computer processor chip, where data are worked upon in some way. A *status register* is a register which is used to return information to a programmer about the operations which took place in other registers. Status registers contain flags which give yes or no answers to questions concerning the other registers. In advanced programming, there may be call for "pseudo registers" in addition to "real" ones. A pseudo register is merely a register which is created by the programmer in computer memory (it does not exist inside a processor).

Messages are just like pseudo status registers: they are collections of flags which signal special information between different devices and/or different programs in a computer system. Messages do not necessarily have fixed locations: they may be passed a parameters. Messages are a very compact way of passing information to low level functions in a program. Flags, registers, pseudo-registers and messages are all treated as bit patterns. A program which makes use of them must therefore be able to assign these objects to C variables for use. A bit pattern would normally be declared as a character or some kind of integer type in C, perhaps with the aid of a typedef statement.

```
typedef char byte;

typedef int bitpattern;

bitpattern variable;
byte message;
```

The flags or bits in a register/message... have the values 1 or 0, depending upon whether they are on or off (set or cleared). A program can test for this by using combinations of the operators which C provides.

## 24.3 Bit Operators and Assignments

C provides the following operators for handling bit patterns:

<<	Bit shift left (a specified number or bit positions)
>>	Bit shift right(a specified number of bit positions)
	Bitwise Inclusive OR
^	Bitwise Exclusive OR
&	Bitwise AND



<code>~</code>	Bitwise one's complement
<code>&amp;=</code>	AND assign (variable = variable & value)
<code> =</code>	Exclusive OR assign (variable = variable   value)
<code>^=</code>	Inclusive OR assign (variable = variable ^ value)
<code>&gt;&gt;=</code>	Shift right assign (variable = variable >> value)
<code>&lt;&lt;=</code>	Shift left assign (variable = variable << value)

The meaning and the syntax of these operators is given below.

## 24.4 The Meaning of Bit Operators

Bitwise operations are not to be confused with logical operations (`&&`, `||`...) A bit pattern is made up of 0s and 1s and bitwise operators operate individually upon each bit in the operand. Every 0 or 1 undergoes the operations individually. Bitwise operators (AND, OR) can be used in place of logical operators (`&&`, `||`), but they are less efficient, because logical operators are designed to reduce the number of comparisons made, in an expression, to the optimum: as soon as the truth or falsity of an expression is known, a logical comparison operator quits. A bitwise operator would continue operating to the last before the final result were known.

Below is a brief summary of the operations which are performed by the above operators on the bits of their operands.

## 24.5 Shift Operations

Imagine a bit pattern as being represented by the following group of boxes. Every box represents a bit; the numbers inside represent their values. The values written over the top are the common integer values which the whole group of bits would have, if they were interpreted collectively as an integer.

```

128 64 32 16 8 4 2 1
-----
| 0 | 0 | 0 | 0 | 0 | 0 | 0 | 1 |      = 1
-----

```

Shift operators move whole bit patterns left or right by shunting them between boxes. The syntax of this operation is:

```

value << number of positions

value >> number of positions

```

So for example, using the boxed value (1) above:

```
1 << 1
```

would have the value 2, because the bit pattern would have been moved one place to the left:

```

128 64 32 16 8 4 2 1
-----
| 0 | 0 | 0 | 0 | 0 | 0 | 1 | 0 | = 2
-----

```

Similarly:

```
1 << 4
```

has the value 16 because the original bit pattern is moved by four places:

```

128 64 32 16 8 4 2 1
-----
| 0 | 0 | 0 | 1 | 0 | 0 | 0 | 0 | = 16
-----

```

And:

```
6 << 2 == 12
```

```

128 64 32 16 8 4 2 1
-----
| 0 | 0 | 0 | 0 | 0 | 1 | 1 | 0 | = 6
-----

```

Shift left 2 places:

```

128 64 32 16 8 4 2 1
-----
| 0 | 0 | 0 | 0 | 1 | 1 | 0 | 0 | = 12
-----

```

Notice that every shift left multiplies by 2 and that every shift right would divide by two, integerwise. If a bit reaches the edge of the group of boxes then it falls out and is lost forever. So:

```

1 >> 1 == 0
2 >> 1 == 1
2 >> 2 == 0
n >> n == 0

```

A common use of shifting is to scan through the bits of a bitpattern one by one in a loop: this is done by using *masks*.

## 24.6 Truth Tables and Masking

The operations AND, OR (inclusive OR) and XOR/EOR (exclusive OR) perform comparisons or "masking" operations between two bits. They are binary or dyadic operators. Another operation called COMPLEMENT is a unary operator. The operations performed by these bitwise operators are best summarized by *truth tables*. Truth tables indicate what the results of all possible operations are between two single bits. The same operation is then carried out for all the bits in the variables which are operated upon.

### 24.6.1 Complement ~

The complement of a number is the *logical opposite* of the number. C provides a "one's complement" operator which simply changes all 1s into 0s and all 0s into 1s.

```
~1 has the value 0      (for each bit)
~0 has the value 1
```

As a truth table this would be summarized as follows:

```
~value == result
0       1
1       0
```

### 24.6.2 AND &

This works between two values. e.g. (1 & 0)

```
value 1 & value 2 == result
0       0       0
0       1       0
1       0       0
1       1       1
```

Both value 1 AND value 2 have to be 1 in order for the result to be 1.

### 24.6.3 OR |

This works between two values. e.g. (1 | 0)

```
value 1 | value 2 == result
0       0       0
0       1       1
```

1	0	1
1	1	1

The result is 1 if one OR the other OR both of the values is 1.

#### 24.6.4 XOR/EOR $\wedge$

Operates on two values. e.g.  $(1 \wedge 0)$

<i>value 1</i>	$\wedge$	<i>value 2</i>	$==$	<i>result</i>
0		0		0
0		1		1
1		0		1
1		1		0

The result is 1 if one OR the other (but not both) of the values is 1.

Bit patterns and logic operators are often used to make *masks*. A mask is as a thing which fits over a bit pattern and modifies the result in order perhaps to single out particular bits, usually to cover up part of a bit pattern. This is particularly pertinent for handling flags, where a programmer wishes to know if one particular flag is set or not set and does not care about the values of the others. This is done by deliberately inventing a value which only allows the particular flag of interest to have a non-zero value and then ANDing that value with the flag register. For example: in symbolic language:

```
MASK = 00000001

VALUE1 = 10011011
VALUE2 = 10011100

MASK & VALUE1 == 00000001
MASK & VALUE2 == 00000000
```

The zeros in the mask *masks off* the first seven bits and leave only the last one to reveal its true value. Alternatively, masks can be built up by specifying several flags:

```
FLAG1 = 00000001
FLAG2 = 00000010
FLAG3 = 00000100

MESSAGE = FLAG1 | FLAG2 | FLAG3

MESSAGE == 00000111
```

It should be emphasized that these expressions are only written in symbolic language: it is not possible to use binary values in C. The programmer must convert to hexadecimal, octal or denary first. (See the appendices for conversion tables).

## 24.7 Example

A simple example helps to show how logical masks and shift operations can be combined. The first program gets a denary number from the user and converts it into binary. The second program gets a value from the user in binary and converts it into hexadecimal.

```

/*****
/*
/* Bit Manipulation #1
/*
/*****

/* Convert denary numbers into binary */
/* Keep shifting i by one to the left */
/* and test the highest bit. This does*/
/* NOT preserve the value of i */

#include <stdio.h>
#define NUMBEROFBITS 8

/*****

main ()

{ short i,j,bit;;
  short MASK = 0x80;

printf ("Enter any number less than 128: ");
scanf ("%h", &i);

if (i > 128)
{
printf ("Too big\n");
return (0);
}

printf ("Binary value = ");

for (j = 0; j < NUMBEROFBITS; j++)
{
bit = i & MASK;
printf ("%1d",bit/MASK);
i <<= 1;
}

printf ("\n");
}

/* end */

```

## 24.8 Output

```
Enter any number less than 128: 56
Binary value = 00111000
```

```
Enter any value less than 128: 3
Binary value = 00000011
```

## 24.9 Example

```

/*****
/*
/* Bit Manipulation #2
/*
/*****

    /* Convert binary numbers into hex */

#include <stdio.h>
#define NUMBEROFBITS 8

/*****

main ()

{ short j,hex = 0;
  short MASK;
  char binary[NUMBEROFBITS];

printf ("Enter an 8-bit binary number: ");

for (j = 0; j < NUMBEROFBITS; j++)
  {
  binary[j] = getchar();
  }

for (j = 0; j < NUMBEROFBITS; j++)
  {
  hex <<= 1;
  switch (binary[j])
  {
  case '1' : MASK = 1;
            break;
  case '0' : MASK = 0;
            break;
  default  : printf("Not binary\n");
            return(0);
  }
  hex |= MASK;
  }

```

```
printf ("Hex value = %1x\n",hex);
}

/* end */
```

## 24.10 Example

```
Enter any number less than 128: 56
Binary value = 00111000
```

```
Enter any value less than 128: 3
Binary value = 00000011
```

## 24.11 Questions

1. What distinguishes a bit pattern from an ordinary variable? Can any variable be a bit pattern?
2. What is the difference between an inclusive OR operation and an exclusive OR operation?
3. If you saw the following function call in a program, could you guess what its parameter was?

```
OpenWindow (BORDER | GADGETS | MOUSECONTROL | SIZING);
```

4. Find out what the denary (decimal) values of the following operations are:
  1.  $7 \& 2$
  2.  $1 \& 1$
  3.  $15 \& 3$
  4.  $15 \& 7$
  5.  $15 \& 7 \& 3$

Try to explain the results. (Hint: draw out the numbers as binary patterns, using the program listed.)
5. Find out what the denary (decimal) values of the following operations are:
  1.  $1 | 2$
  2.  $1 | 2 | 3$
6. Find out the values of:
  1.  $1 \& (\sim 1)$
  2.  $23 \& (\sim 23)$
  3.  $2012 \& (\sim 2012)$

(Hint: write a short program to work them out. Use `short` type variables for all the numbers).



## 25 Files and Devices

Files are places for reading data from or writing data to. This includes disk files and it includes devices such as the printer or the monitor of a computer. C treats all information which enters or leaves a program as though it were a stream of bytes: a file. The most commonly used file streams are `stdin` (the keyboard) and `stdout` (the screen), but more sophisticated programs need to be able to read or write to files which are found on a disk or to the printer etc.

An operating system allows a program to see files in the outside world by providing a number of channels or 'portals' ('inlets' and 'outlets') to work through. In order to examine the contents of a file or to write information to a file, a program has to *open* one of these portals. The reason for this slightly indirect method of working is that channels/portals hide operating system dependent details of filing from the programmer. Think of it as a protocol. A program which writes information does no more than pass that information to one of these portals and the operating system's filing subsystem does the rest. A program which reads data simply reads values from its file portal and does not have to worry about how they got there. This is extremely simple to work in practice. To use a file then, a program has to go through the following routine:

- Open a file for reading or writing. (Reserve a portal and locate the file on disk or whatever.)
- Read or write to the file using file handling functions provided by the standard library.
- Close the file to free the operating system "portal" for use by another program or file.

A program opens a file by calling a standard library function and is returned a file pointer, by the operating system, which allows a program to address that particular file and to distinguish it from all others.

### 25.1 Files Generally

C provides two levels of file handling; these can be called high level and low level. High level files are all treated as text files. In fact, the data which go into the files are exactly what would be seen on the screen, character by character, except that they are stored in a file instead. This is true whether a file is meant to store characters, integers, floating point types. Any file,

which is written to by high level file handling functions, ends up as a text file which could be edited by a text editor.

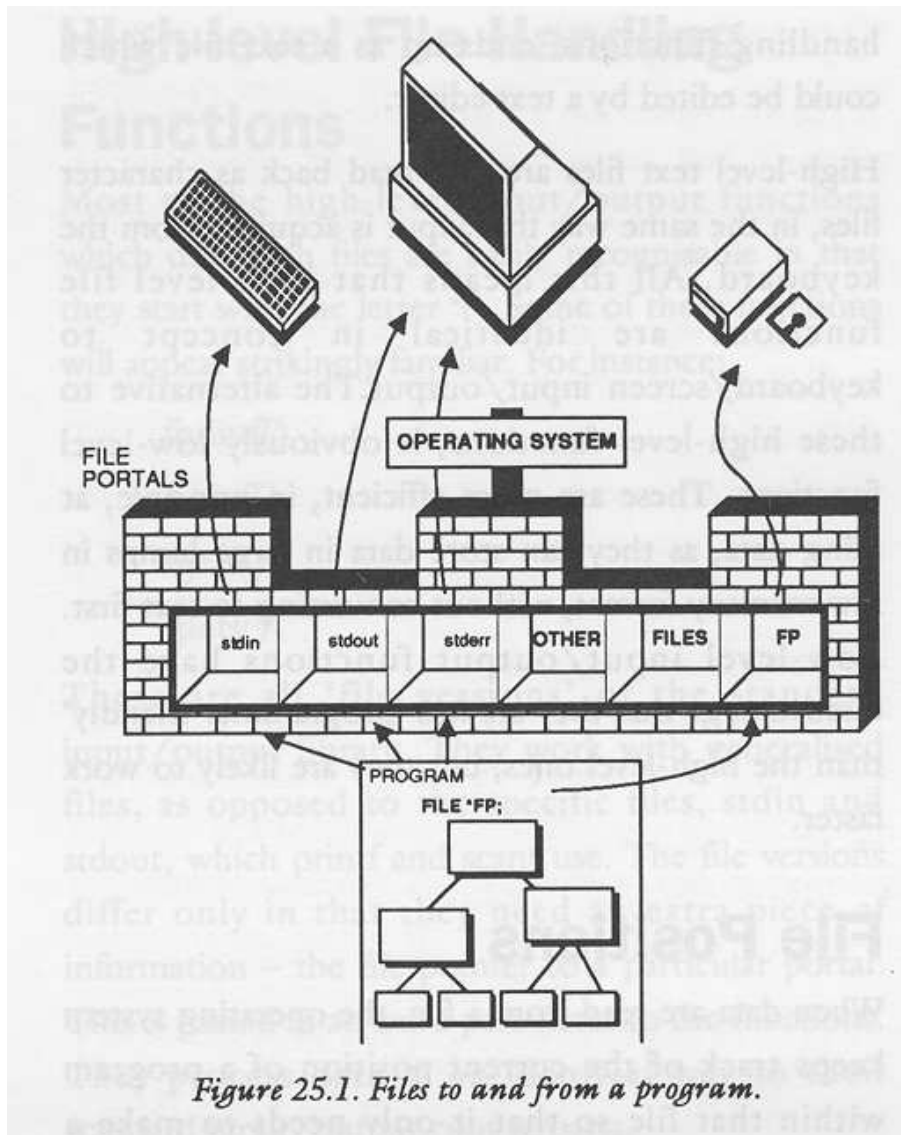

*Figure 25.1. Files to and from a program.*

High level text files are also read back as character files, in the same way that input is acquired from the keyboard. This all means that high level file functions are identical in concept to keyboard/screen input/output.

The alternative to these high level functions, is obviously low level functions. These are more efficient, in principle, at filing data as they can store data in large lumps, in raw memory format, without converting to text files

first. Low level input/output functions have the disadvantage that they are less ‘programmer friendly’ than the high level ones, but they are likely to work faster.

## 25.2 File Positions

When data are read from a file, the operating system keeps track of the current position of a program within that file so that it only needs to make a standard library call to ‘read the next part of the file’ and the operating system obliges by reading some more and advancing its position within the file, until it reaches the end. Each single character which is read causes the position in a file to be advanced by one.

Although the operating system does a great deal of hand holding regarding file positions, a program can control the way in which that position changes with functions such as `ungetc()` if need be. In most cases it is not necessary and it should be avoided, since complex movements within a file can cause complex movements of a disk drive mechanism which in turn can lead to wear on disks and the occurrence of errors.

## 25.3 High Level File Handling Functions

Most of the high level input/output functions which deal with files are easily recognizable in that they start with the letter ‘f’. Some of these functions will appear strikingly familiar. For instance:

```
fprintf()
fscanf()
fgets()
fputs()
```

These are all generalized file handling versions of the standard input/output library. They work with generalized files, as opposed to the specific files `stdin` and `stdout` which `printf()` and `scanf()` use. The file versions differ only in that they need an extra piece of information: the file pointer to a particular portal. This is passed as an extra parameter to the functions. they process data in an identical way to their standard I/O counterparts. Other filing functions will not look so familiar. For example:

```
fopen()
fclose()
getc()
ungetc();
putc()
fgetc()
fputc()
feof()
```

Before any work can be done with high level files, these functions need to be explained in some detail.

## 25.4 Opening files

A file is opened by a call to the library function `fopen()`: this is available automatically when the library file `<stdio.h>` is included. There are two stages to opening a file: firstly a file portal must be found so that a program can access information from a file at all. Secondly the file must be physically located on a disk or as a device or whatever. The `fopen()` function performs both of these services and, if, in fact, the file it attempts to open does not exist, that file is created anew. The syntax of the `fopen()` function is:

```
FILE *returnpointer;

returnpointer = fopen("filename","mode");
```

or

```
FILE returnpointer;
char *fname, *mode;

returnpointer = fopen(fname,mode);
```

The filename is a string which provides the name of the file to be opened. Filenames are system dependent so the details of this must be sought from the local operating system manual. The operation mode is also a string, chosen from one of the following:

'r'	Open file for reading
'w'	Open file for writing
'a'	Open file for appending
'rw'	Open file for reading and writing (some systems)

This mode string specifies the way in which the file will be used. Finally, `returnpointer` is a pointer to a `FILE` structure which is the whole object of calling this function. If the file (which was named) opened successfully when `fopen()` was called, `returnpointer` is a pointer to the file portal. If the file could not be opened, this pointer is set to the value `NULL`. This should be tested for, because it would not make sense to attempt to write to a file which could not be opened or created, for whatever reason.

A read only file is opened, for example, with some program code such as:

```
FILE *fp;

if ((fp = fopen ("filename","r")) == NULL)
```

```

{
printf ("File could not be opened\n");
error_handler();
}

```

A question which springs to mind is: what happens if the user has to type in the name of a file while the program is running? The solution to this problem is quite simple. Recall the function `filename()` which was written in chapter 20.

```

char *filename()                /* return filename */

{ static char *filenm = ".....";

do
{
printf ("Enter filename :");
scanf ("%24s",filenm);
skipgarb();
}
while (strlen(filenm) == 0);
return (filenm);
}

```

This function makes file opening simple. The programmer would now write something like:

```

FILE *fp;
char *filename();

if ((fp = fopen (filename(),"r")) == NULL)

{
printf ("File could not be opened\n");
error_handler();
}

```

and then the user of the program would automatically be prompted for a filename. Once a file has been opened, it can be read from or written to using the other library functions (such as `fprintf()` and `fscanf()`) and then finally the file has to be closed again.

## 25.5 Closing a file

A file is closed by calling the function `fclose()`. `fclose()` has the syntax:

```

int returncode;
FILE *fp;

returncode = fclose (fp);

```

`fp` is a pointer to the file which is to be closed and `returncode` is an integer value which is 0 if the file was closed successfully. `fclose()` prompts the file manager to finish off its dealings with the named file and to close the portal which the operating system reserved for it. When closing a file, a program needs to do something like the following:

```
if (fclose(fp) != 0)
{
    printf ("File did not exist.\n");
    error_handler();
}
```

## 25.6 fprintf()

This is the highest level function which writes to files. Its name is meant to signify "file-print-formatted" and it is almost identical to its `stdout` counterpart `printf()`. The form of the `fprintf()` statement is as follows:

```
fprintf (fp,"string",variables);
```

where `fp` is a file pointer, `string` is a control string which is to be formatted and the variables are those which are to be substituted into the blank fields of the format string. For example, assume that there is an open file, pointed to by `fp`:

```
int i = 12;
float x = 2.356;
char ch = 's';

fprintf (fp, "%d %f %c", i, x, ch);
```

The conversion specifiers are identical to those for `printf()`. In fact `fprintf()` is related to `printf()` in a very simple way: the following two statements are identical.

```
printf ("Hello world %d", 1);

fprintf (stdout,"Hello world %d", 1);
```

## 25.7 fscanf()

The analogue of `scanf()` is `fscanf()` and, as with `fprintf()`, this function differs from its standard I/O counterpart only in one extra parameter: a file pointer. The form of an `fscanf()` statement is:

```
FILE *fp;
```

```
int n;  
  
n = fscanf (fp,"string",pointers);
```

where `n` is the number of items matched in the control string and `fp` is a pointer to the file which is to be read from. For example, assuming that `fp` is a pointer to an open file:

```
int i = 10;  
float x = -2.356;  
char ch = 'x';  
  
fscanf (fp, "%d %f %c", &i, &x, &ch);
```

The remarks which were made about `scanf()` also apply to this function: `fscanf()` is a 'dangerous' function in that it can easily get out of step with the input data unless the input is properly formatted.

## 25.8 skipfilegarb() ?

Do programs need a function such as `skipgarb()` to deal with instances of badly formatted input data? A programmer can assume a bit more about files which are read into a program from disk file than it can assume about the user's typed input. A disk file will presumably have been produced by the same program which generated it, or will be in a format which the program expects. Is a function like `skipgarb()` necessary then? The answer is: probably not. This does not mean to say that a program does not need to check for "bad files", or files which do not contain the data they are alleged to contain. On the other hand, a programmer is at liberty to assume that any file which does not contain correctly formatted data is just nonsense: he/she does not have to try to make sense of it with a function like `skipgarb()`, the program could simply return an error message like "BAD FILE" or whatever and recover in a sensible way. It would probably not make sense to use a function like `skipgarb()` for files. For comparison alone, `skipfilegarb()` is written below.

```
skipfilegarb(fp)  
  
FILE *fp;  
  
{  
while (getc(fp) != '\n')  
    {  
    }  
}
```

## 25.9 Single Character I/O

There are commonly four functions/macros which perform single character input/output to or from files. They are analogous to the functions/macros

```
getchar()
putchar()
```

for the standard I/O files and they are called:

```
getc()
ungetc();
putc()
fgetc()
fputc()
```

## 25.10 getc() and fgetc()

The difference between `getc()` and `fgetc()` will depend upon a particular system. It might be that `getc()` is implemented as a macro, whereas `fgetc()` is implemented as a function or vice versa. One of these alternatives may not be present at all in a library. Check the manual, to be sure! Both `getc()` and `fgetc()` fetch a single character from a file:

```
FILE *fp;
char ch;

/* open file */

ch = getc (fp);
ch = fgetc (fp);
```

These functions return a character from the specified file if they operated successfully, otherwise they return `EOF` to indicate the end of a file or some other error. Apart from this, these functions/macros are quite unremarkable.

## 25.11 ungetc()

`ungetc()` is a function which ‘un-gets’ a character from a file. That is, it reverses the effect of the last get operation. This is not like writing to a file, but it is like stepping back one position within the file. The purpose of this function is to leave the input in the correct place for other functions in a program when other functions go too far in a file. An example of this would be a program which looks for a word in a text file and processes that word in some way.

```
while (getc(fp) != ' ')
{
}
```



The program would skip over spaces until it found a character and then it would know that this was the start of a word. However, having used `getc()` to read the first character of that word, the position in the file would be the second character in the word! This means that, if another function wanted to read that word from the beginning, the position in the file would not be correct, because the first character would already have been read. The solution is to use `ungetc()` to move the file position back a character:

```
int returncode;

returncode = ungetc(fp);
```

The returncode is EOF if the operation was unsuccessful.

## 25.12 putc() and fputc()

These two functions write a single character to the output file, pointed to by `fp`. As with `getc()`, one of these may be a macro. The form of these statements is:

```
FILE *fp;
char ch;
int returncode;

returncode = fputc (ch,fp);
returncode = putc (ch,fp);
```

The returncode is the ascii code of the character sent, if the operation was successful, otherwise it is EOF.

## 25.13 fgets() and fputs()

Just as `gets()` and `puts()` fetched and sent strings to standard input/output files `stdin` and `stdout`, so `fgets()` and `fputs()` send strings to generalized files. The form of an `fgets()` statement is as follows:

```
char *strbuff,*returnval;
int n;
FILE *fp;

returnval = fgets (strbuff,n,fp);
```

`strbuff` is a pointer to an input buffer for the string; `fp` is a pointer to an open file. `returnval` is a pointer to a string: if there was an error in `fgets()` this pointer is set to the value `NULL`, otherwise it is set to the value of `"strbuff"`. No more than `(n-1)` characters are read by `fgets()` so the programmer has to be sure to set `n` equal to the size of the string buffer. (One byte is reserved for the `NULL` terminator.) The form of an `fputs()` statement is as follows:

```

char *str;
int returnval;
FILE *fp;

returnval = fputs (str,fp);

```

Where `str` is the NULL terminated string which is to be sent to the file pointed to by `fp`. `returnval` is set to `EOF` if there was an error in writing to the file.

## 25.14 feof()

This function returns a true or false result. It tests whether or not the end of a file has been reached and if it has it returns 'true' (which has any value except zero); otherwise the function returns 'false' (which has the value zero). The form of a statement using this function is:

```

FILE *fp;
int outcome;

outcome = feof(fp);

```

Most often `feof()` will be used inside loops or conditional statements. For example: consider a loop which reads characters from an open file, pointed to by `fp`. A call to `feof()` is required in order to check for the end of the file.

```

while (!feof(fp))
{
    ch = getc(fp);
}

```

Translated into pidgin English, this code reads: 'while NOT end of file, `ch` equals get character from file'. In better(?) English the loop continues to fetch characters as long as the end of the file has not been reached. Notice the logical NOT operator '!' which stands before `feof()`.

## 25.15 Printer Output

Any serious application program will have to be in full control of the output of a program. For instance, it may need to redirect output to the printer so that data can be made into hard copies. To do this, one of three things must be undertaken:

- `stdout` must be redirected so that it sends data to the printer device.
- A new "standard file" must be used (not all C compilers use this method.)

- A new file must be opened in order to write to the printer device

The first method is not generally satisfactory for applications programs, because the standard files `stdin` and `stdout` can only easily be redirected from the operating system command line interpreter (when a program is run by typing its name). Examples of this are:

```
type file > PRN
```

which send a text file to the printer device. The second method is reserved for only a few implementations of C in which another 'standard file' is opened by the local operating system and is available for sending data to the printer stream. This file might be called "stdprn" or "standard printer file" and data could be written to the printer by switching writing to the file like this:

```
fprintf (stdprn,"string %d..", integer);
```

The final method of writing to the printer is to open a file to the printer, personally. To do this, a program has to give the "filename" of the printer device. This could be something like "PRT:" or "PRN" or "LPRT" or whatever. The filename (actually called a pseudo device name) is used to open a file in precisely the same way as any other file is opened: by using a call to `fopen()`. `fopen()` then returns a pointer to file (which is effectively "stdprn") and this is used to write data to a computer's printer driver. The program code to do this should look something like the following:

```
FILE *stdprn;

if ((stdprn = fopen("PRT:","w")) == NULL)
{
    printf ("Printer busy or disconnected\n");
    error_handler;
}
```

## 25.16 Example

Here is an example program which reads a source file (for a program, written in C, Pascal or whatever...) and lists it, along with its line numbers. This kind of program is useful for debugging programs. The program provides the user with the option of sending the output to the printer. The printer device is assumed to have the filename "PRT:". Details of how to convert the program for other systems is given at the end.

```

/*****/
/*
/* LIST : program file utility
/*
/*****/
```

```

/* List a source file with line numbers attached. Like */
/* TYPE only with lines numbers too. */

#include <stdio.h>

#define CODE 0
#define SIZE 255
#define ON 1
#define OFF 0
#define TRUE 1
#define FALSE 0

FILE *fin;
FILE *fout = stdout; /* where output goes to */

/*****
/* Level 0 */
*****/

main ()

{ char strbuff[size],*filename();
  int Pon = false;
  int line = 1;

printf ("Source Program Lister V1.0\n\n");

if ((fin = fopen(filename(),"r")) == NULL)
  {
  printf ("\nFile not found\n");
  exit (CODE);
  }

printf ("Output to printer? Y/N");

if (yes())
  {
  Pon = Printer(ON);
  }

while (!feof(fin))
  {
  if (fgets(strbuff,size,fin) != strbuff)
    {
    if (!feof(fin))
      {
      printf ("Source file corrupted\n");
      exit (CODE);
      }
    }
  fprintf (fout,"%4d %s",line++,strbuff);

```

```

    }

    CloseFiles(Pon);
}

/*****
/* Level 1
*****/

CloseFiles(Pon)                /* close & tidy */

int Pon;

{
if (Pon)
    {
    Printer(OFF);
    }

if (fclose(fin) != 0)
    {
    printf ("Error closing input file\n");
    }

}

/*****
Printer (status)                /* switch printer file */

int status;

{
switch (status)
    {
    case on:   while ((fout = fopen("PRT:", "w")) == NULL)
                {
                printf ("Printer busy or disconnected\n");
                printf ("\n\nRetry? Y/N\n");
                if (!yes())
                    {
                    exit(CODE);
                    }
                }

                break;

    case off:  while (fclose(fout) != 0)
                {
                printf ("Waiting to close printer stream\r");
                }

    }
}

```

```

}

/*****
/* Toolkit
*****/

char *filename()          /* return filename */

{ static char *filenm = ".....";

do
  {
  printf ("Enter filename :");
  scanf ("%24s",filenm);
  skipgarb();
  }
while (strlen(filenm) == 0);

return (filenm);
}

/*****
yes ()          /* Get a yes/no response from the user */

{ char ch;

while (TRUE)
  {
  ch = getchar();
  skipgarb();

  switch (ch)
    {
    case 'y' : case 'Y' : return (TRUE);
    case 'n' : case 'N' : return (FALSE);
    }
  }
}

/*****
skipgarb()          /* skip garbage corrupting input */

{
while (getchar() != '\n')
  {
  }
}

/* end */

```

## 25.17 Output

Here is a sample portion of the output of this program as applied to one of the example programs in section 30.

```

1 /*****
2 /*
3 /* C programming utility : variable referencer */
4 /*
5 /*****
6
7             /* See section 30 */
8
9 #include <stdio.h>
10 #include <ctype.h>
11
12 #define TRUE      1
13 #define FALSE     0
14 #define DUMMY     0
15 #define MAXSTR    512
16 #define MAXIDSIZE 32

```

*... and more of the same.*

## 25.18 Converting the example

The example program could be altered to work with a standard printer file "stdprn" by changing the following function.

```

Printer (status)             /* switch printer file */

int status;

{
switch (status)
{
case on:  fout = stdprn;
          break;

case off: fout = stdout;
}
}

```

## 25.19 Filing Errors

The standard library provides an error function/macro which returns a true/false result according to whether or not the last filing function call

returned an error condition. This is called `ferror()`. To check for an error in an open file, pointed to by `fp`:

```
FILE *fp;

if (ferror(fp))
{
    error_handler();
}
```

This function/macro does not shed any light upon the cause of errors, only whether errors have occurred at all. A detailed diagnosis of what went wrong is only generally possible by means of a deeper level call to the disk operating system (DOS).

## 25.20 Other Facilities for High Level Files

Files which have been opened by `fopen()` can also be handled with the following additional functions:

```
fread()
fwrite()

ftell()
fseek()
rewind()
fflush()
```

These functions provide facilities to read and write whole blocks of characters in one operation as well as further facilities to locate and alter the current focus of attention within a file. They offer, essentially, low level filing operations for files which have been opened for high level use!

## 25.21 `fread()` and `fwrite()`

These functions read and write whole blocks of characters at a time. The form of `fread()` is as follows:

```
FILE *fp;
int  nread,n,size;
char *ptr;

nread = fread (ptr,size,n,fp);
```

The parameters in parentheses provide information about where the data will be stored once they have been read from a file. `fp` is a pointer to an open file; `ptr` is a pointer to the start of a block of memory which is to store the data when it is read; `size` is the size of a block of data in characters; `n` is the number of blocks of data to be read. Finally `nread` is a return value which indicates the number of blocks which was actually read during the



operation. It is important to check that the number of blocks expected is the same as the number received because something could have gone wrong with the reading process. (The disk might be corrupted or the file might have been altered in some way.) `fwrite()` has an identical call structure to `fread()`:

```
FILE *fp;
int  nowritten,n,size;
char *ptr;

nowritten = fread (ptr,size,n,fp);
```

This time the parameters in parentheses provide information about where the data, to be written to a file, will be found. `fp` is a pointer to an open file; `ptr` is a pointer to the start of a block of memory at which the data are stored; `size` is the size of a "block" of data in characters; `n` is the number of blocks of data to be read; `nowritten` is a return value which indicates the actual number of blocks which was written. Again, this should be checked.

A caution about these functions: each of these block transfer routines makes an important assumption about the way in which data are stored in the computer system. It is assumed that the data are stored *contiguously* in the memory, that is, side by side, in sequential memory locations. In some systems this can be difficult to arrange (in multi-tasking systems in particular) and almost impossible to guarantee. Memory which is allocated in C programs by the function `malloc()` does not guarantee to find contiguous portions of memory on successive calls. This should be noted carefully when developing programs which use these calls.

## 25.22 File Positions: `ftell()` and `fseek()`

`ftell()` tells a program its position within a file, opened by `fopen()`. `fseek()` seeks a specified place within a file, opened by `fopen()`. Normally high level read/write functions perform as much management over positions inside files as the programmer wants, but in the event of their being insufficient, these two routines can be used. The form of the function calls is:

```
long int pos;
FILE *fp;

pos = ftell(fp);
```

`fp` is an open file, which is in some state of being read or written to. `pos` is a long integer value which describes the position in terms of the number of characters from the beginning of the file. Aligning a file portal with a particular place in a file is more sophisticated than simply taking note of the current position. The call to `fseek()` looks like this:

```

long int pos;
int mode,returncode;
FILE *fp;

returncode = fseek (fp,pos,mode);

```

The parameters have the following meanings. `fp` is a pointer to a file opened by `fopen()`. `pos` is some way of describing the position required within a file. `mode` is an integer which specifies the way in which `pos` is to be interpreted. Finally, `returncode` is an integer whose value is 0 if the operation was successful and -1 if there was an error.

- 0            `pos` is an offset measured relative to the beginning of the file.
- 1            `pos` is an offset measured relative to the current position.
- 2            `pos` is an offset measured relative to the end of the file.

Some examples help to show how this works in practice:

```

long int pos = 50;
int mode = 0,returncode;
FILE *fp;

if (fseek (fp,pos,mode) != 0) /* find 50th character */
{
    printf("Error!\n");
}

fseek(fp,0L,0);           /* find beginning of file */
fseek(fp,2L,0);           /* find the end of a file */

if (fseek (fp,10L,1) != 0) /* move 10 char's forward */
{
    printf("Error!\n");
}

```

The L's indicate long constants.

### 25.23 `rewind()`

`rewind()` is a macro, based upon `fseek()`, which resets a file position to the beginning of the file. e.g.

```

FILE *fp;

rewind(fp);

fseek(fp,0L,0);           /* = rewind() */

```

## 25.24 fflush()

This is a macro/function which can be used on files which have been opened for writing or appending. It flushes the output buffer which means that it forces the characters in the output buffer to be written to the file. If used on files which are open for reading, it causes the input buffer to be emptied (assuming that this is allowed at all). Example:

```
FILE *fp;

fflush(fp);
```

## 25.25 Low Level Filing Operations

Normally a programmer can get away with using the high level input/output functions, but there may be times when C's predilection for handling all high level input/output as text files, becomes a nuisance. A program can then use a set of low level I/O functions which are provided by the standard library. These are:

```
open()
close()
creat()
read()
write()
rename()
unlink()/remove()
lseek()
```

These low level routines work on the operating system's end of the file portals. They should be regarded as being advanced features of the language because they are dangerous routines for bug ridden programs. The data which they deal with is untranslated: that is, no conversion from characters to floating point or integers or any type at all take place. Data are treated as a raw stream of bytes. Low level functions should not be used on any file at the same time as high level routines, since high level file handling functions often make calls to the low level functions.

Working at the low level, programs can create, delete and rename files but they are restricted to the reading and writing of untranslated data: there are no functions such as `fprintf()` or `fscanf()` which make type conversions. As well as the functions listed above a local operating system will doubtless provide special function calls which enable a programmer to make the most of the facilities offered by the particular operating environment. These will be documented, either in a compiler manual, or in an operating system manual, depending upon the system concerned. (They might concern special graphics facilities or windowing systems or provide ways of writing special system dependent data to disk files, such as date/time stamps etc.)

## 25.26 File descriptors

At the low level, files are not handled using file pointers, but with integers known as file handles or file descriptors. A file handle is essentially the number of a particular file portal in an array. In other words, for all the different terminology, they describe the same thing. For example:

```
int fd;
```

would declare a file *handle* or *descriptor* or *portal* or whatever it is to be called.

## 25.27 open()

`open()` is the low level file open function. The form of this function call is:

```
int fd, mode;
char *filename;

fd = open (filename,mode);
```

where `filename` is a string which holds the name of the file concerned, `mode` is a value which specifies what the file is to be opened for and `fd` is either a number used to distinguish the file from others, or -1 if an error occurred.

A program can give more information to this function than it can to `fopen()` in order to define exactly what `open()` will do. The integer `mode` is a message or a pseudo register which passes the necessary information to `open()`, by using the following flags:

<code>O_RDONLY</code>	Read access only
<code>O_WRONLY</code>	Write access only
<code>O_RDWR</code>	Read/Write access

and on some compilers:

<code>O_CREAT</code>	Create the file if it does not exist
<code>O_TRUNC</code>	Truncate the file if it does exist
<code>O_APPEND</code>	Find the end of the file before each write
<code>O_EXCL</code>	Exclude. Force create to fail if the file exists.

The macro definitions of these flags will be included in a library file: find out which one and `#include` it in the program. The normal procedure is to open a file using one of the first three modes. For example:

```
#define FAILED -1

main()

{ char *filename();
  int fd;
```

```

fd = open(filename(), O_RDONLY);

if (fd == FAILED)
{
    printf ("File not found\n");
    error_handler (failed);
}
}

```

This opens up a read-only file for low level handling, with error checking. Some systems allow a more flexible way of opening files. The four appended modes are values which can be bitwise ORed with one of the first three in order to get more mileage out of `open()`. The bitwise OR operator is the vertical bar "|". For example, to emulate the `fopen()` function a program could opt to create a file if it did not already exist:

```
fd = open (filename(), O_RDONLY | O_CREAT);
```

`open()` sets the file position to zero if the file is opened successfully.

## 25.28 close()

`close()` releases a file portal for use by other files and brings a file completely up to date with regard to any changes that have been made to it. Like all other filing functions, it returns the value 0 if it performs successfully and the value -1 if it fails. e.g.

```

#define FAILED -1

if (close(fd) == FAILED)
{
    printf ("ERROR!");
}

```

## 25.29 creat()

This function creates a new file and prepares it for access using the low level file handling functions. If a file which already exists is created, its contents are discarded. The form of this function call is:

```

int fd, pmode;
char *filename;

fd = creat(filename, pmode);

```

`filename` must be a valid filename; `pmode` is a flag which contains access-privilege mode bits (system specific information about allowed access) and `fd` is a returned file handle. In the absence of any information about `pmode`,

this parameter can be set to zero. Note that, the action of creating a file opens it too. Thus after a call to `creat`, you should close the file descriptor.

### 25.30 read()

This function gets a block of information from a file. The data are loaded directly into memory, as a sequence of bytes. The user must provide a place for them (either by making an array or by using `malloc()` to reserve space). `read()` keeps track of file positions automatically, so it actually reads the next block of bytes from the current file position. The following example reads `n` bytes from a file:

```
int returnvalue, fd, n;
char *buffer;

if ((buffer = malloc(size)) == NULL)
{
    puts ("Out of memory\n");
    error_handler ();
}

returnvalue = read (fd,buffer,n);
```

The return value should be checked. Its values are defined as follows:

- 0           End of file
- 1          Error occurred
- n*          the number of bytes actually read. (If all went well this should be equal to *n*.)

### 25.31 write()

This function is the opposite of `read()`. It writes a block of `n` bytes from a contiguous portion of memory to a file which was opened by `open()`. The form of this function is:

```
int returnvalue, fd, n;
char *buffer;

returnvalue = write (fd,buffer,n);
```

The return value should, again, be checked for errors:

- 1          Error
- n*          Number of bytes written

### 25.32 lseek()

Low level file handing functions have their equivalent of `fseek()` for finding a specific position within a file. This is almost identical to `fseek()` except that it uses the file handle rather than a file pointer as a parameter and has a different return value. The constants should be declared `long int`, or simply `long`.

```
#define FAILED -1L

long int pos,offset,fd;
int mode,returncode;

if ((pos = fseek (fd,offset,mode)) == FAILED)
{
    printf("Error!\n");
}
```

`pos` gives the new file position if successful, and -1 (long) if an attempt was made to read past the end of the file. The values which `mode` can take are:

- 0           Offset measured relative to the beginning of the file.
- 1           Offset measured relative to the current position.
- 2           Offset measured relative to the end of the file.

### 25.33 unlink() and remove()

These functions delete a file from disk storage. Once deleted, files are usually irretrievable. They return -1 if the action failed.

```
#define FAILED -1

int returnvalue;
char *filename;

if (unlink (filename) == FAILED)
{
    printf ("Can't delete %s\n",filename);
}

if (remove (filename) == FAILED)
{
    printf ("Can't delete %s\n",filename);
}
```

`filename` is a string containing the name of the file concerned. This function can fail if a file concerned is protected or if it is not found or if it is a device. (It is impossible to delete the printer!)

rename()

This function renames a file. The programmer specifies two filenames: the old filename and a new file name. As usual, it returns the value -1 if the action fails. An example illustrates the form of the `rename()` call:

```
#define FAILED -1

char *old,*new;

if (rename(old,new) == FAILED)
{
    printf ("Can't rename %s as %s\n",old,new);
}
```

`rename()` can fail because a file is protected or because it is in use, or because one of the filenames given was not valid.

### 25.34 Example

This example strings together some low level filing actions so as to illustrate their use in a real program. The idea is to present a kind of file or "project" menu for creating, deleting, renaming files. A rather feeble text editor allows the user to enter 255 characters of text which can be saved.

```

/*****
/*
/* LOW LEVEL FILE HANDLING
/*
/*****

#include <stdio.h>
#include <ctype.h>
#include <fcntl.h>      /* defines O_RDONLY etc.. */

#define CODE    0
#define SIZE    255
#define FNMSIZE 30      /* Max size of filenames */
#define TRUE    1
#define FALSE   0
#define FAILED  -1

#define CLRSCRN() putchar('\f')
#define NEWLINE() putchar('\n')

int fd;

/*****
/* Level 0
/*****

main ()
```



```

{ char *data, getkey(), *malloc();

if ((data = malloc(SIZE)) == NULL)
{
    puts ("Out of memory\n");
    return (CODE);
}

while (TRUE)
{
    menu();
    switch (getkey())
    {
        case 'l' : LoadFile(data);
                    break;
        case 's' : SaveFile(data);
                    break;
        case 'e' : Edit(data);
                    break;
        case 'd' : DeleteFile();
                    break;
        case 'r' : RenameFile();
                    break;
        case 'q' : if (sure())
                    {
                        return (CODE);
                    }
                    break;
    }
}
}

/*****
/* Level 1
*****/

menu ()

{
CLRSCRN();
printf (" -----\n");
printf ("|          MENU          |\n");
printf ("|          ~~~~~          |\n");
printf ("|                          |\n");
printf ("|          L) Load File   |\n");
printf ("|          S) Save File   |\n");
printf ("|          E) Edit File   |\n");
printf ("|          D) Delete File  |\n");
printf ("|          R) Rename File  |\n");
printf ("|          Q) Quit        |\n");
printf ("|                          |\n");
printf ("|          Select Option and RETURN |\n");
}

```

```

printf ("|                                     |\n");
printf (" ----- \n");
NEWLINE();
}

/*****

LoadFile(data)                                     /* Low level load */

char *data;

{ char *filename(),getkey();
  int error;

fd = open(filename(), O_RDONLY);

if (fd == FAILED)
  {
  printf ("File not found\n");
  return (FAILED);
  }

error = read (fd,data,SIZE);

if (error == FAILED)
  {
  printf ("Error loading file\n");
  wait();
  }
else
  {
  if (error != SIZE)
    {
    printf ("File was corrupted\n");
    wait();
    }
  }

close (fd,data,SIZE);
return (error);
}

*****/

SaveFile(data)                                     /* Low Level save */

char *data;

{ char *filename(),getkey(),*fname;
  int error,fd;

fd = open ((fname = filename()), O_WRONLY);

```

```

if (fd == FAILED)
{
    printf ("File cannot be written to\n");
    printf ("Try to create new file? Y/N\n");
    if (yes())
    {
        if ((fd = CreateFile(fname)) == FAILED)
        {
            printf ("Cannot create file %s\n",fname);
            return (FAILED);
        }
    }
    else
    {
        return (FAILED);
    }
}

error = write (fd,data,SIZE);

if (error < SIZE)
{
    printf ("Error writing to file\n");
    if (error != FAILED)
    {
        printf ("File only partially written\n");
    }
}

close (fd,data,SIZE);
wait();
return (error);
}

/*****

Edit(data)                                /* primitive text editor */

char *data;

{ char *ptr;
  int ctr = 0;

printf ("Contents of file:\n\n");

for (ptr = data; ptr < (data + SIZE); ptr++)
{
    if (isprint(*ptr))
    {
        putchar(*ptr);
        if ((ctr++ % 60) == 0)

```

```

        {
            NEWLINE();
        }
    }
}

printf ("\n\nEnter %1d characters:\n",SIZE);

for (ptr = data; ptr < (data + SIZE); ptr++)
    {
        *ptr = getchar();
    }

skipgarb();
}

/*****

DeleteFile()          /* Delete a file from current dir */

{ char *filename(),getkey(),*fname;

printf ("Delete File\n\n");

fname = filename();
if (sure())
    {
        if (remove(fname) == FAILED)
            {
                printf ("Can't delete %s\n",fname);
            }
    }
else
    {
        printf ("File NOT deleted!\n");
    }

wait();
}

*****/

RenameFile()

{ char old[FNMSIZE],*new;

printf ("Rename from OLD to NEW\n\nOLD: ");
strcpy (old,filename());
printf ("\nNEW: ");
new = filename();

if (rename(old,new) == FAILED)

```

```

    {
        printf ("Can't rename %s as %s\n",old,new);
    }

wait();
}

/*****
/* Level 2
*****/

CreateFile (fname)

char *fname;

{ int fd;

if ((fd = creat(fname,0)) == FAILED)
    {
        printf ("Can't create file %s\n",fname);
        return (FAILED);
    }

return (fd);
}

/*****
/* Toolkit
*****/

char *filename()          /* return filename */

{ static char statfilenm[FNMSIZE];

do
    {
        printf ("Enter filename :");
        scanf ("%24s",statfilenm);
        skipgarb();
    }
while (strlen(statfilenm) == 0);
return (statfilenm);
}

/*****

sure ()          /* is the user sure ? */

{
printf ("Are you absolutely, unquestionably certain? Y/N\n");
return(yes());
}

```

```

/*****/

yes()

{ char getkey();

while (TRUE)
{
    switch(getkey())
    {
        case 'y' : return (TRUE);
        case 'n' : return (FALSE);
    }
}
}

/*****/

wait()

{ char getkey();

printf ("Press a key\n");
getkey();
}

/*****/

char getkey()          /* single key + RETURN response */

{ char ch;

ch = getchar();
skipgarb();
return((char)tolower(ch));
}

/*****/

skipgarb()            /* skip garbage corrupting input */

{
while (getchar() != '\n')
{
}
}

/* end */

```

## 25.35 Questions

1. What are the following?
  1. File name
  2. File pointer
  3. File handle
2. What is the difference between high and low level filing?
3. Write a statement which opens a high level file for reading.
4. Write a statement which opens a low level file for writing.
5. Write a program which checks for illegal characters in text files. Valid characters are ASCII codes 10,13,and 32..126. Anything else is illegal for programs.
6. What statement performs formatted writing to text files?
7. Print out all the header files on your system so that you can see what is defined where!





## 26 Structures and Unions

*Grouping data. Tidying up programs.*

Tidy programs are a blessing to programmers. Tidy data are just as important. As programs become increasingly complex, their data also grow in complexity and single, independent variables or arrays are no longer enough. What one then needs is a **data structure**. This is where a new type of variable comes in: it is called a **struct** type, or in other languages, a record. **struct** types or *structures* are usually lumped together with another type of variable called a **union**. In fact their purposes are quite different.

### 26.1 Organization: Black Box Data

What is the relationship between a program and its data? Think of a program as an operator which operates on the memory of the computer. Local data are operated upon inside sealed function capsules, where they are protected from the reach of certain parts of a program. Global data are wide open to alteration by any part of a program. If a program were visualized schematically what would it look like? A traditional flow diagram? No: a computer program only looks like a flow diagram at the machine code

level and that is too primitive for C programmers. One way of visualizing a program is illustrated by the diagram over the page.

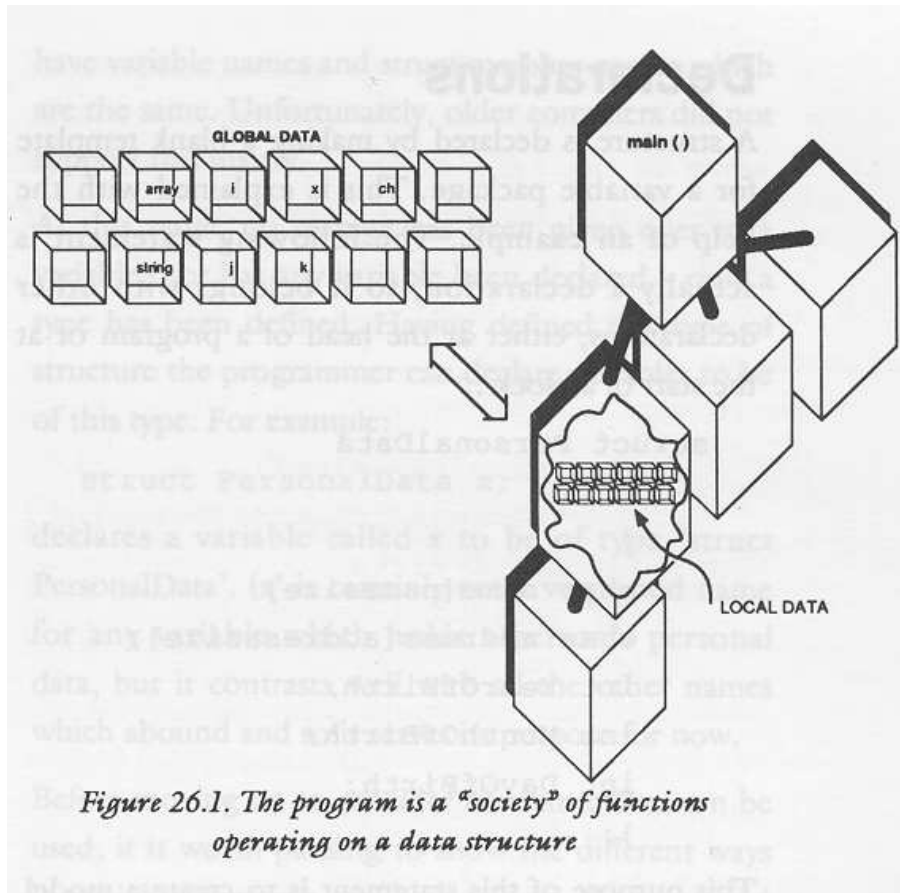

This shows a program as a kind of society of sealed function capsules which work together like a beehive of activity upon a honeycomb of program data. This imaginative idea is not a bad picture of a computer program, but it is not complete either. A program has to manipulate data: it has to look at them, move them around and copy them from place to place. All of these things would be very difficult if data were scattered about liberally, with no particular structure. For this reason C has the facility, within it, to make sealed capsules – not of program code – but of program data, so that all of these actions very simply by grouping variables together in convenient packages for handling. These capsules are called structures.

## 26.2 struct

A *structure* is a package of one or usually more variables which are grouped under a single name. Structures are not like arrays: a structure can hold any mixture of different types of data: it can even hold arrays of different types. A structure can be as simple or as complex as the programmer desires.

The word **struct** is a reserved word in C and it represents a new data type, called an aggregate type. It is not any single type: the purpose of structures is to offer a tool for making whatever shape or form of variable package that a programmer wishes. Any particular structure type is given a name, called a structure-name and the variables (called members) within a structure type are also given names. Finally, every variable which is declared to be a particular structure type has a name of its own too. This plethora of names is not really as complicated as it sounds.

## 26.3 Declarations

A structure is declared by making a blank template for a variable package. This is most easily seen with the help of an example. The following statement is actually a declaration, so it belongs with other declarations, either at the head of a program or at the start of a block.

```
struct PersonalData
{
    char name[namesize];
    char address[addresssize];
    int YearOfBirth;
    int MonthOfBirth;
    int DayOfBirth;
};
```

This purpose of this statement is to create a model or template to define what a variable of type **struct PersonalData** will look like. It says: define a type of variable which collectively holds a string called **name**, a string called **address** and three integers called **YearOfBirth**, **MonthOfBirth** and **DayOfBirth**. Any variable which is declared to be of type **struct PersonalData** will be collectively made up of parts like these. The list of variable components which make up the structure are called the members of the structure: the names of the members are not the names of variables, but are a way of naming the parts which make up a structure variable. (Note: a variable which has been declared to be of type **struct something** is usually called just a structure rather than a structure variable. The distinction is maintained here in places where confusion might arise.) The names of members are held separate from the names of other identifiers in C, so it is quite possible to have variable names and struct member names which are the same. Older compilers did not support this luxury.

At this stage, no storage has been given over to a variable, nor has any variable been declared: only a type has been defined. Having defined this type of structure, however, the programmer can declare variables to be of this type. For example:

```
struct PersonalData x;
```

declares a variable called `x` to be of type `struct PersonalData`. `x` is certainly not a very good name for any variable which holds a person's personal data, but it contrasts well with all the other names which are about and so it serves its purpose for now.

Before moving on to consider how structures can be used, it is worth pausing to show the different ways in which structures can be declared. The method shown above is probably the most common one, however there are two equivalent methods of doing the same thing. A variable can be declared immediately after the template definition.

```
struct PersonalData
{
    char name[namesize];
    char address[addresssize];
    int YearOfBirth;
    int MonthOfBirth;
    int DayOfBirth;
}
x;          /* variable identifier follows type */
```

Alternatively, `typedef` can be used to cut down a bit on typing in the long term. This type definition is made once at the head of the program and then subsequent declarations are made by using the new name:

```
typedef struct
{
    char name[namesize];
    char address[addresssize];
    int YearOfBirth;
    int MonthOfBirth;
    int DayOfBirth;
}
PersonalData;
```

then declare:

```
PersonalData x;
```

Any one of these methods will do.

## 26.4 Scope

Both structure types and structure variables obey the rules of scope: that is to say, a structure type declaration can be local or global, depending upon where the declaration is made. Similarly if a structure type variable is declared locally it is only valid inside the block parentheses in which it was defined.

```
main ()
{
    struct ONE
    {
        int a;
        float b;
    };

    struct ONE x;
}

function ()
{
    struct ONE x;          /* This line is illegal, since ONE */
                          /* is a local type definition    */
                          /* Defined only in main()        */
}
```

## 26.5 Using Structures

How does a program use the variables which are locked inside structures? The whole point about structures is that they can be used to group data into sensible packages which can then be treated as single objects. Early C compilers, some of which still exist today, placed very severe restrictions upon what a program could do with structures. Essentially, the members of a structure could be assigned values and pointers to individual structures could be found. Although this sounds highly restrictive, it did account for the most frequent uses of structures. Modern compilers allow more flexible use of structures: programs can assign one structure variable to another structure variable (provided the structures match in type); structure variables can be passed, whole, as parameters to functions and functions can return structure values. This makes structures extremely powerful data objects to have in a program. A structure is assigned to another structure by the following statements.

```
struct Personal x,y;

x = y;
```

The whole bundle of members is copied in one statement! Structures are passed as parameters in the usual way:

```
function (x,y);
```

The function then has to be declared:

```
function (x,y)
struct PersonalData x,y;
{
}
```

Finally, a function which returns a structure variable such as:

```
{ struct PersonalData x,function();
x = function();
}
```

would be declared in the following way:

```
struct PersonalData function ()
{
}
```

Notice that the return type of such a function must also be declared in the function which calls that it, in the usual way. The reader will begin to see that structure names account for a good deal of typing! The typedef statement is a very good way of reducing this burden.

The members of a structure are accessed with the '.' dot character. This is a structure *member operator*. Consider the structure variable `x`, which has the type `struct PersonalData`. The members of `x` could be assigned by the following program:

```
main ()
{ struct PersonalData x;
FillArray ("Some name", x.name);
FillArray ("Some address", x.address);
x.YearOfBirth = 1987;
x.MonthOfBirth = 2;
x.DayOfBirth = 19;
}
```

where `FillArray()` is a hypothetical function which copies the string in the first parameter to the array in the second parameter. The dot between the variable and the names which follow implies that the statements in this brief program are talking about the members in the structure variable `x`, rather

than the whole collective bundle. Members of actual structure variables are always accessed with this dot operator. The general form of a member reference is:

```
structure variable.member name
```

This applies to any type of structure variable, including those accessed by pointers. Whenever a program needs to access the members of a structure, this dot operator can be used. C provides a special member operator for pointers, however, because they are used so often in connection with structures. This new operator is described below.

## 26.6 Arrays of Structures

Just as arrays of any basic type of variable are allowed, so are arrays of a given type of structure. Although a structure contains many different types, the compiler never gets to know this information because it is hidden away inside a sealed structure capsule, so it can believe that all the elements in the array have the same type, even though that type is itself made up of lots of different types. An array would be declared in the usual way:

```
int i;

struct PersonalData x,array[size];
```

The members of the arrays would then be accessed by statements like the following examples:

```
array[i] = x;

array[i] = array[j];

array[i].YearOfBirth = 1987;

i = array[2].MonthOfBirth;
```

## 26.7 Example

This listing uses a structure type which is slightly different to `PersonalData` in that string pointers are used instead of arrays. This allows more convenient handling of real-life strings.

```

/*****
/*
/* Structures Demo
/*
/*
/*****

/* Simple program to initialize some structures */
```

```

    /* and to print them out again. Does no error  */
    /* checking, so be wary of string sizes etc.. */

#include <stdio.h>

#define NAMESIZE    30
#define ADDRSIZE    80
#define NOOFPERSONS 20
#define NEWLINE()  putchar('\n');

/*****

typedef struct
{
    char *Name;
    char *Address;
    int YearOfBirth;
    int MonthOfBirth;
    int DayOfBirth;
}
PersonDat;

/*****

main ()                /* Make some records */

{ PersonDat record[NOOFPERSONS];
  PersonDat PersonalDetails();
  int person;

printf ("Birth Records For Employees");
printf ("\n-----");
printf ("\n\n");

printf ("Enter data\n");

for (person = 0; person < NOOFPERSONS; person++)
{
    record[person] = PersonalDetails();
    NEWLINE();
}

DisplayRecords (record);
}

/*****

PersonDat PersonalDetails() /* No error checking! */

{ PersonDat dat;
  char strbuff[ADDRSIZE], *malloc();

```



```

printf ("Name :");
dat.Name = malloc(NAMESIZE);
strcpy (dat.Name,gets(strbuff));

printf ("Address :");
dat.Address = malloc(ADDRSIZE);
strcpy (dat.Address,gets(strbuff));

printf ("Year of birth:");
dat.YearOfBirth = getint (1900,1987);

printf ("Month of birth:");
dat.MonthOfBirth = getint (1,12);

printf ("Day of birth:");
dat.DayOfBirth = getint(1,31);

return (dat);
}

/*****/

DisplayRecords (rec)

PersonDat rec[NOOFPERSONS];

{ int pers;

for (pers = 0; pers < NOOFPERSONS; pers++)
{
printf ("Name : %s\n", rec[pers].Name);
printf ("Address : %s\n", rec[pers].Address);
printf("Date of Birth: %1d/%1d/%1d\n",rec[pers].DayOfBirth,
rec[pers].MonthOfBirth,rec[pers].YearOfBirth);
NEWLINE();
}
}

/*****/
/* Toolkit */
/*****/

getint (a,b) /* return int between a and b */

int a,b;

{ int p, i = a - 1;

for (p=0; ((a > i) || (i > b)); p++)
{
printf ("? : ");
scanf ("%d",&i);
}
}

```

```

    if (p > 2)
    {
        skipgarb();
        p = 0;
    }
}
skipgarb();
return (i);
}

/*****
skipgarb()      /* Skip input garbage corrupting scanf */

{
while (getchar() != '\n')
    {
    }
}

/* end */

```

## 26.8 Structures of Structures

Structures are said to nest. This means that structure templates can contain other structures as members. Consider two structure types:

```

struct first_structure
{
    int value;
    float number;
};

```

and

```

struct second_structure
{
    int tag;
    struct first_structure fs;
}
x;

```

These two structures are of different types, yet the first of the two is included in the second! An instance of the second structure would be initialized by the following assignments. The structure variable name is `x`:

```

x.tag = 10;
x.fs.value = 20;
x.fs.number = 30.0;

```

Notice the way in which the member operator ‘.’ can be used over and over again. Notice also that no parentheses are necessary, because the reference which is calculated by this operator is worked out from left to right. This nesting can, in principle, go on many times, though some compilers might place restrictions upon this nesting level. Statements such as:

```
variable.tag1.tag2.tag3.tag4 = something;
```

are probably okay (though they do not reflect good programming). Structures should nest safely a few times.

A word of caution is in order here. There is a problem with the above scheme that has not yet been addressed. It is this: what happens if a structure contains an instance of itself? For example:

```
struct Regression
{
    int i;
    struct Regression tag;
}
```

There is simply no way that this kind of statement can make sense, unless the compiler’s target computer has an infinite supply of memory! References to variables of this type would go on for ever and an infinite amount of memory would be needed for every variable. For this one reason, it is forbidden for a structure to contain an instance of itself. What is not forbidden, however, is for a structure to contain an instance of a pointer to its own type (because a pointer is not the same type as a structure: it is merely a variable which holds the address of a structure). Pointers to structures are quite invaluable, in fact, for building data structures such as linked lists and trees. These extremely valuable devices are described below.

## 26.9 Pointers to Structures

A pointer to a structure type variable is declared by a statement like:

```
struct Name *ptr;
```

`ptr` is then, formally, a pointer to a structure of type `Name` only. `ptr` can be assigned to any other pointer of similar type and it can be used to access the members of a structure. It is in the second of these actions that a new structure operator is revealed. According to the rules which have described so far, a structure member could be accessed by pointers with the following statements:

```
struct PersonalData *ptr;

(*ptr).YearOfBirth = 20;
```

This says let the member `YearOfBirth` of the structure pointed to by `ptr`, have the value 20. Notice that `*ptr`, by itself, means the contents of the address which is held in `ptr` and notice that the parentheses around this statement avoid any confusion about the precedence of these operators. There is a better way to write the above statement, however, using a new operator: `'->'`. This is an arrow made out of a minus sign and a greater than symbol and it is used simply as follows:

```
struct PersonalData *ptr;

ptr->YearOfBirth = 20;
```

This statement is identical in every way to the first version, but since this kind of access is required so frequently, when dealing with structures, C provides this special operator to make the operation clearer. In the statements above, it is assumed that `ptr` has been assigned to the address of some pre-assigned structure: for example, by means of a statement such as:

```
ptr = &x;
```

where `x` is a pre-assigned structure.

## 26.10 Example

```

/*****
/*
/* Structures Demo #2
/*
/*****

/* This is the same program, using pointer references */
/* instead of straight variable references. i.e. this */
/* uses variable parameters instead of value params */

#include <stdio.h>

#define NAMESIZE 30
#define ADDRSIZE 80
#define NOOFPERSONS 20
#define NEWLINE() putchar('\n');

/*****

typedef struct
{
    char *Name;
    char *Address;
    int YearOfBirth;
    int MonthOfBirth;
    int DayOfBirth;

```

```

    }
    PersonDat;

    /*****
main ()                                /* Make some records */

{ PersonDat record[NOOFPERSONS];
  int person;

printf ("Birth Records For Employees");
printf ("\n-----");
printf ("\n\n");

printf ("Enter data\n");

for (person = 0; person < NOOFPERSONS; person++)
    {
        PersonalDetails(&(record[person]));
        NEWLINE();
    }

DisplayRecords (record);
}

    /*****/

PersonalDetails(dat)    /* No error checking! */

PersonDat *dat;

{ char strbuff[ADDRSIZE], *malloc();

printf ("Name :");
dat->Name = malloc(NAME_SIZE);
strcpy (dat->Name,gets(strbuff));

printf ("Address :");
dat->Address = malloc(ADDRSIZE);
strcpy (dat->Address,gets(strbuff));

printf ("Year of birth:");
dat->YearOfBirth = getint (1900,1987);

printf ("Month of birth:");
dat->MonthOfBirth = getint (1,12);

printf ("Day of birth:");
dat->DayOfBirth = getint(1,31);
}

    /*****/

```

```

DisplayRecords (rec)

PersonDat rec[NOOFPERSONS];

{ int pers;

for (pers = 0; pers < NOOFPERSONS; pers++)
  {
  printf ("Name : %s\n", rec[pers].Name);
  printf ("Address : %s\n", rec[pers].Address);
  printf("Date of Birth: %1d/%1d/%1d\n",rec[pers].DayOfBirth,
        rec[pers].MonthOfBirth,rec[pers].YearOfBirth);
  NEWLINE();
  }
}

/*****
/* Toolkit */
*****/

/* As before */

```

## 26.11 Pre-initializing Static Structures

In the chapter on arrays it was shown how static and external type arrays could be initialized with values at compile time. Static and external structures can also be pre-assigned by the compiler so that programs can set up options and starting conditions in a convenient way. A static variable of type `PersonDat` (as in the example programs) could be declared and initialized in the same statement:

```

#define NAMESIZE 20
#define ADDRESSSIZE 22

struct PersonDat
  {
  char *name;
  char *address;
  int YearOfBirth;
  int MonthOfBirth;
  int DayOfBirth;
  };

main ()

{ static struct PersonalData variable =
  {
  "Alice Wonderment",
  "Somewhere in Paradise",
  1965,

```

```

        5,
        12
    };

    /* rest of program */

}

```

The items in the curly braces are matched to the members of the structure variable and any items which are not initialized by items in the list are filled out with zeros.

## 26.12 Creating Memory for Dynamical struct Types

Probably the single most frequent use of struct type variables is in the building of dynamical data structures. Dynamical data are data which are created explicitly by a program using a scheme of memory allocation and pointers. Normal program data, which are reserved space by the compiler, are, in fact, static data structures because they do not change during the course of a program: an integer is always an integer and an array is always an array: their sizes cannot change while the program is running. A dynamical structure is built using the memory allocation function:

```
malloc()
```

and pointers. The idea is to create the memory space for a new structure as and when it is needed and to use a pointer to access the members of that structure, using the ‘->’ operator. `malloc()` was described in connection with strings: it allocates a fixed number of bytes of memory and returns a pointer to that data. For instance, to allocate ten bytes, one would write something like this:

```

char *malloc(), *ptr;

ptr = malloc(10);

```

`ptr` is then a pointer to the start of that block of 10 bytes. When a program wants to create the space for a structure, it has a template for that structure, which was used to define it, but it does not generally know, in advance, how many bytes long a structure is. In fact, it is seldom possible to know this information, since a structure may occupy more memory than the sum of its parts. How then does a program know how much space to allocate? The C compiler comes to the rescue here, by providing a compile time operator called

```
sizeof ()
```

which calculates the size of an object while a program is compiling. For example:

`sizeof(int)`

Works out the number of bytes occupied by the type `int`.

`sizeof(char)`

Works out the number of bytes occupied by a single character.  
This equals 1, in fact.

`sizeof(struct PersonalData)` works out the number of bytes needed to store a single structure variable. Obviously this tool is very useful for working with `malloc()`. The memory allocation statement becomes something like:

```
ptr = malloc(sizeof(type name));
```

There is a problem with this statement though: `malloc()` is declared as a function which returns a type 'pointer to character' whereas, here, the programmer is interested in pointers of type "pointer to struct Something". `malloc()` has to be forced to produce a pointer of the correct type then and this is done by using the cast operator to mould it into shape. The cast operator casts pointers with a general form:

```
(type *) value
```

Consider the following example of C source code which allocates space for a structure type called `SomeStruct` and creates a correctly aligned pointer to it, called `ptr`.

```
struct SomeStruct *ptr;
char *malloc();

ptr = (struct SomeStruct *) malloc(sizeof(struct SomeStruct));
```

This rather laboured statement provides both the memory and the location of that memory in a legal and type-sensical way. The next section of this book discusses what we can do with dynamically allocated structures.

## 26.13 Unions

A **union** is like a structure in which all the 'members' are stored at the same address. Clearly they cannot all be there at the same time. Only one member can be stored in such an object at any one time, or it would be overwritten by another. Unions behave like specially sized storage containers which can hold many different types of data. A union can hold any one of its members but only at different times. The compiler arranges that a union type variable is big enough to handle the job.

The real purpose of unions is to prevent memory fragmentation by arranging for a standard size for data in the memory. By having a standard data size we can guarantee that any hole left when dynamically allocated memory is freed will always be reusable by another instance of the same type of union. This is a natural strategy in system programming where



many instances of different kinds of variables with a related purpose and stored dynamically.

### 26.13.1 Declaration

A union is declared in the same way as a structure. It has a list of members, which are used to mould the type of object concerned.

```
union IntOrFloat
{
    int ordinal;
    float continuous;
};
```

This declares a type template. Variables are then declared as:

```
union IntOrFloat x,y,z;
```

At different times the program is to treat `x,y` and `z` as being either integers or float types. When the variables are referred to as

```
x.ordinal = 1;
```

the program sees `x` as being an integer type. At other times (when `x` is referred to as `x.continuous`) it takes on another aspect: its alter ego, the float type. Notice that `x` by itself does not have a value: only its members have values, `x` is just a box for the different members to share.

### 26.13.2 Using unions

Unions are coded with the same constructions as structures. The dot `'.'` operator selects the different members for variable and the arrow `'->'` selects different values for pointers. The form of such statements is:

```
union_variable.member;

union_pointer->member;
```

Unions are seldom very useful objects to have in programs, since a program has no automatic way of knowing what type of member is currently stored in the union type. One way to overcome this is to keep a variable which signals the type currently held in the variable. This is done very easily with the aid of enumerated data. Consider the following kind of union:

```
union WhichType
{
    int ordinal;
    float continuous;
    char letter;
};
```

This could be accompanied by an enumerate declaration such as:

```
enum Types
{
    INT,
    FLOAT,
    CHAR
};
```

Variables could then go in pairs:

```
union WhichType x;
enum Types x_status;
```

which would make union type-handling straightforward:

```
switch (x_status)
{
    case INT    : x.ordinal = 12;
                 break;
    case FLOAT  : x.continuous = 12.23;
                 break;
    case CHAR   : x.letter = '*';
}
}
```

These variables could even be grouped into a structure:

```
struct Union_Handler
{
    union WhichType x;
    enum Types x_status;
}
var;
```

which would then require statements such as:

```
var.x.ordinal = 2;

ptr->x.ordinal = 2;

var.x_status = CHAR;
```

and so on...

## 26.14 Questions

1. What is the difference between a structure and a union?
2. What is a member?

3. If `x` is a variable, how would you find out the value of a member called `mem`.
4. If `ptr` is a pointer to a structure, how would you find out the value of a member called `mem`.
5. A union is a group of variables in a single package. True or false?



## 27 Data Structures

*Uses for struct variables. Structure diagrams.*

Data structures are organized patterns of data. The purpose of building a data structure is to create a pattern of information which models a particular situation clearly and efficiently. Take the simplest kind of data structure: the array. Arrays are good for storing patterns of information which look like tables, or share a tabular structure. For example, a chess board looks like a two dimensional array, so a chess game would naturally use a two dimensional array to store the positions of pieces on the chess board. The aim of a data structure is to model real life patterns with program data.

Most real application programs require a more complex data structure than C variables can offer; often arrays are not suitable structures for a given application. To see this, consider an application example in which a program stores a map of the local countryside. This program has to store information about individual towns and it has to be able to give directions to the user about how to get to particular towns from some reference point. In real life, all of this information is most easily conveyed by means of a map, with towns' vital statistics written on it. (See figure 1.) The diagram shows such a simplified map of the surrounding land. This sort of map is, ideally, just what a computer ought to be able to store. The handicap is that the map does not look very computerish. If the map is ever going to be stored in a computer it will need to look more mechanical. A transformation

is needed. In order to make the map into a more computer-like picture, it must be drawn as a structure diagram.

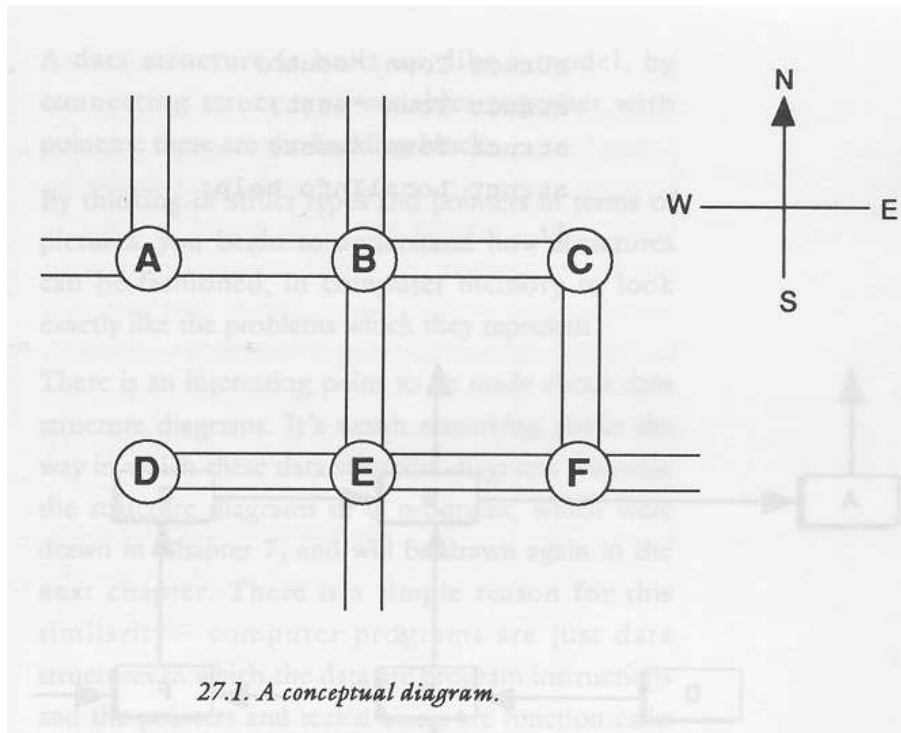

A structure diagram is a picture which shows how something is connected up. Most often a structure diagram shows how a problem is connected up by relating all the parts which go together to make it up. In this case, the structure diagram just shows how program data are related to each other.

## 27.1 Data Structure Diagrams

Now examine figure 2. This diagram is a data structure diagram: it is a diagram which shows how boxes of data must relate to one another in order to solve the problem of the towns map. It has been drawn, quite deliberately, in a way which is intended to conjure up some particular thoughts. The arrows tend to suggest that pointers will play a role in the data structure. The blocks tend to suggest that sealed capsules or `struct` type data will also play a role. Putting these two together creates the idea of a 'town structure' containing pointers to neighbouring villages which lie on roads to the North, South, East and West of the town, as well as the information about the town itself. This town structure might look something like this:

```
struct Town
{
```

```

struct Town *north;
struct Town *south;
struct Town *east;
struct Town *west;
struct LocalInfo help;
};

```

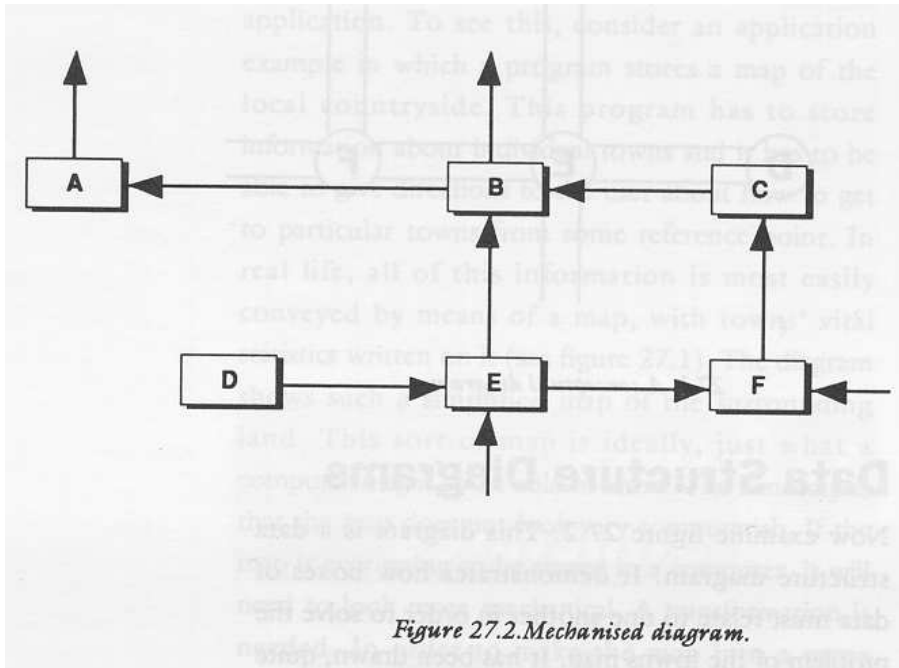

Assume for now that `LocalInfo` is a structure which contains all the information about a town required by the program. This part of the information is actually irrelevant to the structure of the data because it is hidden inside the sealed capsule. It is the pointers which are the main items of concern because it is pointers which contain information that enables a program to find its way around the map very quickly. If the user of this imaginary application program wished to know about the town to the north of one particular place, the program would only have to refocus its attention on the new structure which was pointed to by the struct member `north` and similarly for other directions.

A data structure is built up, like a model, by connecting struct type variables together with pointers: these are the building blocks.

By thinking of struct types and pointers in terms of pictures, one begins to see how structures can be fashioned, in computer memory, to look exactly like the problems which they represent.

What is interesting about data structure diagrams is the way in which they resemble the structure diagrams of C programs, which were drawn in chapter 7. There is a simple reason for this similarity: computer programs are themselves just data structures in which the data are program instructions and the pointers and sealed boxes are function calls. The structure of a computer program is called a hierarchy. Sometimes the shape of data structures and programs are identical; when this happens, a kind of optimum efficiency has been reached in conceptual terms. Programs which behave exactly like their data operate very simply. This is the reason why structure diagrams are so useful in programming: a structure diagram is a diagram which solves a problem and does so in a pictorial way, which models the way we think.

## 27.2 The Tools: Structures, Pointers and Dynamic Memory

The tools of the data structure trade are struct types and pointers. Data structures are built out of dynamically allocated memory, so storage places do not need names: all a program needs to do is to keep a record of a pointer, to a particular storage space, and the computer will be able to find it at any time after that. Pointers are the keys which unlock a program's data. The reader might object to this by saying that a pointer has to be stored in some C variable somewhere, so does a program really gain anything from working with pointers? The answer is yes, because pointers in data structures are invariably chained together to make up the structure. To understand this, make a note of the following terms:

- Root*            This is a place where a data structure starts. Every chain has to start somewhere. The address of the root of a data structure has to be stored explicitly in a C variable.
- Links*            A link is a pointer to a new struct type. Links are used to chain structures together. The address of the next element in a chain structure is stored inside the previous structure.

Data structures do not have to be linear chains and they are often not. Structures, after all, can hold any number of pointers to other structures, so there is the potential to branch out into any number of new structures. In the map example above, there were four pointers in each structure, so the chaining was not linear, but more like a latticework.

We need to think about where and how data structures are going to be stored. Remember that pointers alone do not create any storage space: they are only a way of finding out the contents of storage space which already exists. In fact, a program must create its own space for data structures. The key phrase is dynamic storage: a program makes space for structures as new ones are required and deletes space which it does not require. The functions which perform this memory allocation and release are:

`malloc()`            *and*            `free()`



There are some advantages which go with the use of dynamic storage for data structures and they are summarized by the following points:

- Since memory is allocated as it is needed, the only restriction on data size is the memory capacity of the computer. We don't need to declare how much we shall use in advance.
- Using pointers to connect structures means that they can be re-connected in different ways as the need arises. (Data structures can be sorted, for example.)
- Data structures can be made up of lots of "lesser" data structures, each held inside struct type storage. The limitations are few.

The remaining parts of this section aim to provide a basic plan or formula for putting data structures together in C. This is done with recourse to two example structures, which become two example programs in the next chapter.

### 27.3 Programme For Building Data Structures

In writing programs which centre around their data, such as word processors, accounts programs or database managers, it is extremely important to plan data structures before any program code is written: changes in program code do not affect a data structure, but alterations to a data structure imply drastic changes to program code. Only in some numerical applications does a data structure actually assist an algorithm rather than vice versa. The steps which a programmer would undertake in designing a data structure follow a basic pattern:

- Group all the data, which must be stored, together and define a struct type to hold them.
- Think of a pattern which reflects the way in which the data are connected and add structure pointers to the struct definition, to connect them.
- Design the programming algorithms to handle the memory allocation, link pointers and data storage.

### 27.4 Setting Up A Data Structure

Once the basic mould has been cast for the building blocks, a program actually has to go through the motions of putting all the pieces together, by connecting structures together with pointers and filling them up with information. The data structure is set up by repeating the following actions as many times as is necessary.

- Define a struct type. For example:

```
struct Town
```

```

{
struct Town *north;
struct Town *south;
struct Town *east;
struct Town *west;
struct LocalInfo help;
};

```

- Declare two pointers to this type:

```
struct Town *ptr,*root;
```

One of these is used to hold the root of the data structure and the other is used as a current pointer.

- Allocate memory for one structure type:

```
root = (struct Town *) malloc(sizeof(struct Town));
```

Be careful to check for errors. `root` will be `NULL` if no memory could be allocated.

- Initialize the members of the structure with statements such as:

```

root->north = NULL;
root->south = NULL;
root->help.age = 56; /* if age is a member */
                  /* of struct LocalInfo */

```

This sets the pointers `north` and `south` to the value `NULL`, which conventionally means that the pointer does not point anywhere.

- When other structures have been created, the pointers can be assigned to them:

```

ptr = (struct Town *) malloc(sizeof(struct Town));
ptr->north = NULL;
ptr->south = NULL;

/* etc.. initialize members */

root->north = ptr;

```

This last statement connects the new structure onto the north branch of `root`.

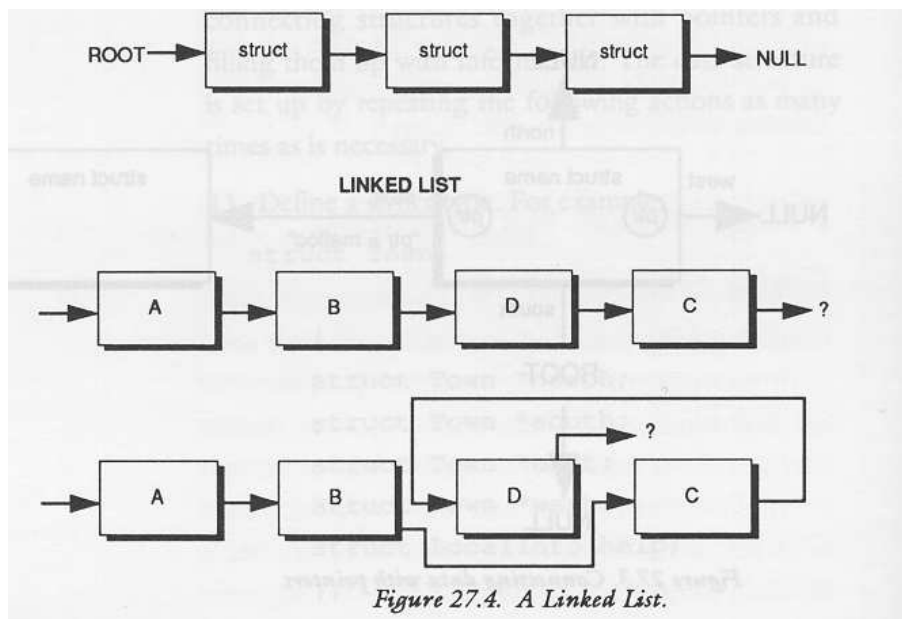

NULL pointer assignments tell the program handling the data structure when it has come to the edge of the structure: that is when it has found a pointer which doesn't lead anywhere.

## 27.5 Example Structures

Two data structures of this kind are very common: the *linked list* and the *binary tree* and both work upon the principles outlined above (In fact they are just different manifestations of the same thing.)

A linked list is a linear sequence of structures joined together by pointers. If a structure diagram were drawn of a linked list, all the storage blocks in it would lie in a straight line, without branching out.

```
struct list
{
  double value;
  struct list *succ;
};
```

A linked list has only a single pointer per structure, which points to the successor in the list. If the blocks were labelled A B C D E... then B would be the successor of A; C would be the successor of B and so on. Linked lists have two advantages over one dimensional arrays: they can be sorted easily (see diagram) and they can be made any length at all.

A binary tree is a sequence of structures, each of which branches out into two new ones.

```

struct BinaryTree
{
    /* other info */

    struct BinaryTree *left;
    struct BinaryTree *right;
}

*tree = NULL;

```

A binary tree structure has two pointers per struct type. This is useful for classifying data on a greater than/less than basis.

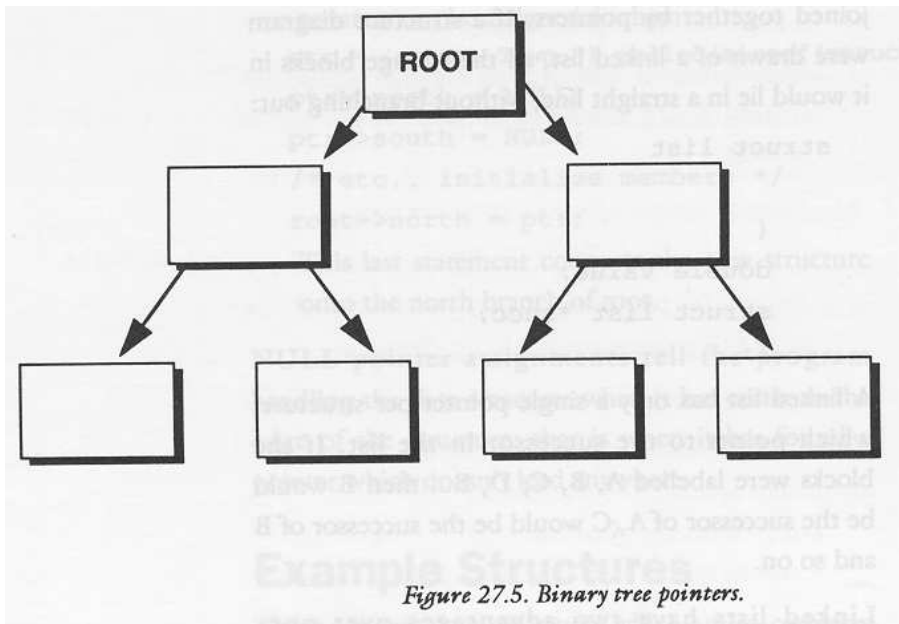

Right and left branches are taken to mean ‘greater than’ and ‘less than’ respectively. The programs which handle these data structures are written in the form of complete, usable application programs. They are simple by professional standards, but they are long by book standards so they are contained in a section by themselves, along with their accompanying programmers’ documentation, See [\(undefined\)](#) [Example Programs chapter], page [\(undefined\)](#).

## 27.6 Questions

1. What is a structure diagram?
2. How are data linked together to make a data structure?

3. Every separate struct type in a data structure has its own variable name. True or false?
4. How are the members of structures accessed in a data structure?
5. Write a statement which creates a new structure of type "struct BinaryTree" and finds its address. Store that address in a variable which is declared as follows:

```
struct BinaryTree *ptr;
```

6. Write a small program which makes a linked list, three structures long and assigns all their data to be zero. Can you automate this program with a loop? Can you make it work for any number of structures?



## 28 Recursion

*The daemon which swallowed its tail.*

This section is about program structures which can talk about themselves. What happens to a function which makes a call itself? Examine the function below:

```
Well_Function ()  
  
{  
/* ... other statements ... */  
  
Well_Function ();  
}
```

`Well_Function()` is said to be a recursive function. It is defined in terms of itself: it contains itself and it calls itself. It swallows its own tail! The act of self-reference is called recursion. What happens to such a function when it is called in a C program? In the simple example above, something dramatic and fatal happens. The computer, naturally, begins executing the statements in the function, inside the curly braces. This much is only normal: programs are designed to do this and the computer could do no more and no less. Eventually the program comes upon the statement `Well_Function()`; and it makes a call to that function again. It then begins executing statements in `Well_function()`, from the beginning, as though it were a new function, until it comes upon the statement `Well_Function()` and then it calls the function again....

This kind of function calling scenario is doomed to continue without end, as, each time the function is called, it is inevitably called again. The computer becomes totally consumed with the task of calling `Well_Function()` over and over. It is apparently doomed to repeat the same procedure for ever. Or is it?

### 28.1 Functions and The Stack

We should think about the exact sequence of events which takes place when a function is called in a program. This will help to cast some light on the mechanics of recursion and recursive functions. When a function is called, control passes from one place in a program to another place. The statements in this new region of the program are carried out and then control returns to a statement immediately following the one which made the function call. But how does the computer know where it must go back to, when it has finished with a function call? It is suddenly thrown into a wildly different region of the memory and finds itself executing statements there. How can it

get back again? A diagram does not answer this question: program structure diagrams hide this detail from view.

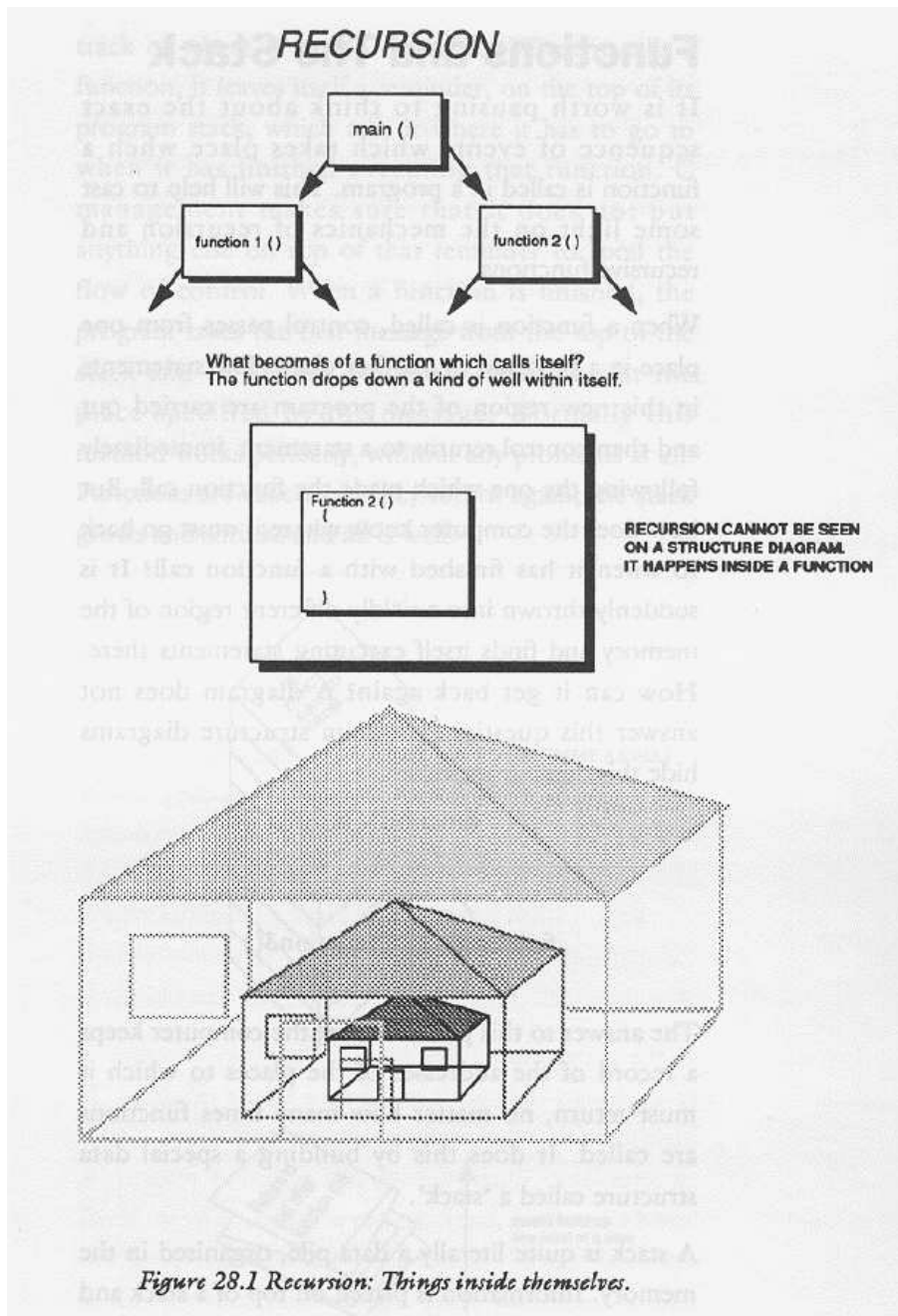



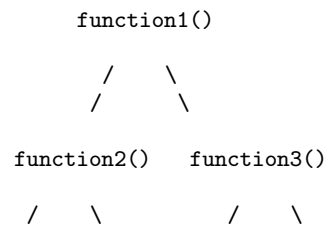

The answer to this puzzle is that the computer keeps a record of the addresses of the places to which it must return, no matter how many times functions are called. It does this by building a special data structure called a **stack**.

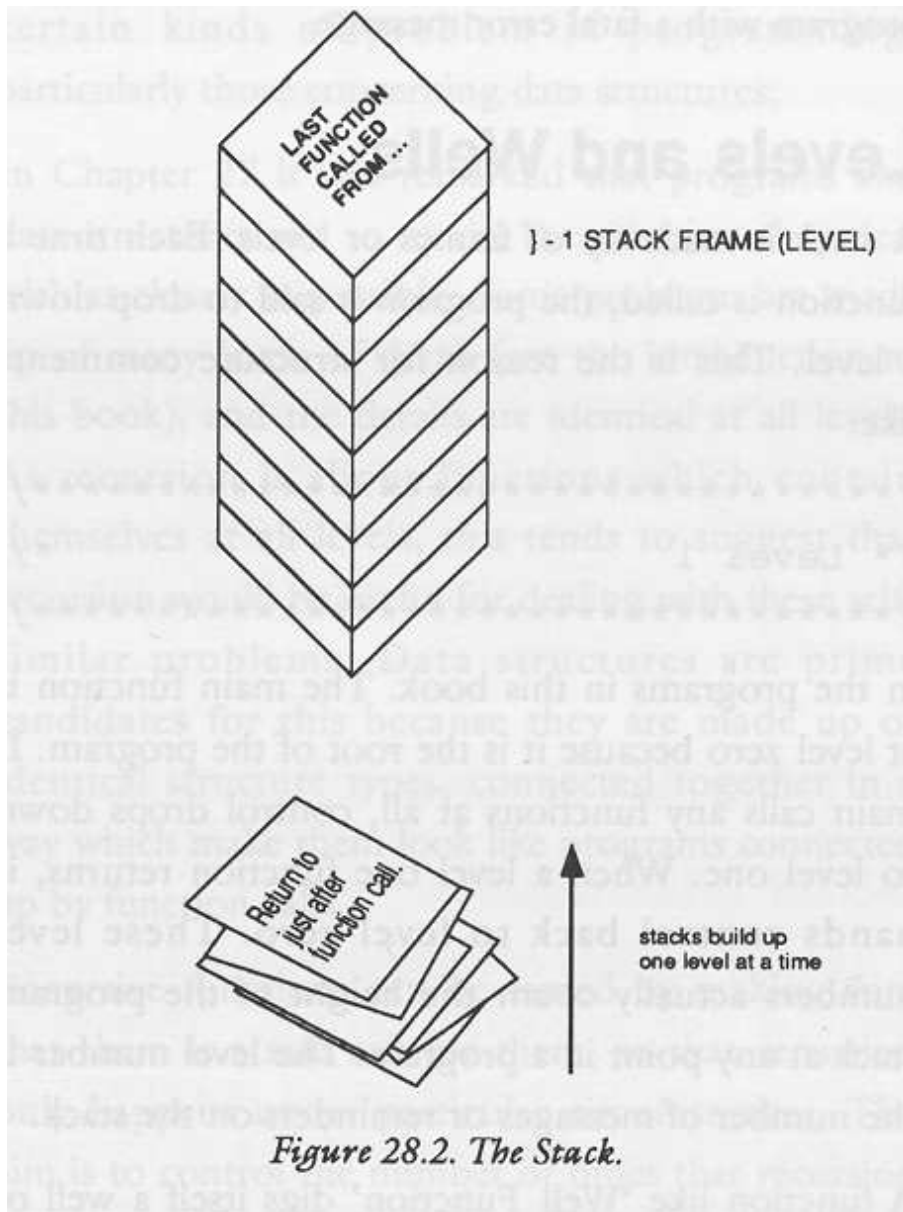

A stack is quite literally a pile of data, organized in the memory. Information is placed on top of a stack and taken from the top. It is called a *last in, first out* (LIFO) structure because the last thing to go on the top of a

stack is always the first thing to come off it. C organizes a stack structure when it runs a program and uses it for storing local variables and for keeping track of where it has to return to. When it calls a function, it leaves itself a reminder, on the top of its program stack, which tells it where it has to go to when it has finished executing that function. C management makes sure that it does not put anything else on top of that reminder to spoil the flow of control. When a function is finished, the program takes the first message from the top of the stack and carries on executing statements at the place specified by the message. Normally this method works perfectly, without any problems at all: functions are called and they return again; the stack grows and shrinks and all is well.

What happens when a recursive function, like `Well_Function()` calls itself? The system works as normal. C makes a note of the place it has to return to and puts that note on top of the stack. It then begins executing statements. When it comes to the call `Well_Function()` again, it makes a new note of where it has to come back to and deposits it on top of the stack. It then begins the function again and when it finds the function call, it makes a new note and puts on the top of the stack.... As this process continues, the memory gets filled up with the program's messages to itself: the stack of messages gets larger and larger. Since the function has no chance of returning control to its caller, the messages never get taken off the stack and it just builds up. Eventually the computer runs out of memory and the computer crashes or interrupts the program with a fatal error message.

## 28.2 Levels and Wells

A stack is made up of frames or levels. Each time a function is called, the program is said to drop down a level. This is the reason for structure comments like:

```

/*****
/* Level 1                               */
/*****

```

in the programs in this book. The `main()` function is at level 0 because it is the root of the program. If `main()` calls any functions at all, control drops down to level one. When a level one function returns, it hands control back to level zero. These level numbers actually count the height of the program stack at any point in a program. The level number is the number of messages or reminders on the stack.

A function like `Well_Function()` digs itself a well of infinite depth. It punches a great hole in a program; it has no place in a levelled structure diagram. The function is pathological because it causes the stack fill up the memory of the computer. A better name for this function would be:

```

StackOverflow() /* Causes stack to grow out of control */

```

```
{
StackOverflow();
}
```

### 28.3 Tame Recursion and Self-Similarity

Recursion does not have to be so dramatically disastrous as the example given. If recursion is tamed, it provides perhaps the most powerful way of handling certain kinds of problem in programming, particularly concerning data structures.

Earlier we remarked that programs and data structures aim to model the situation they deal with as closely as possible. Some problems are made up of many levels of detail (see the introduction to this tutorial) and the details are identical at all levels. Since recursion is about functions which contain themselves at all levels, this tends to suggest that recursion would be useful for dealing with these self-similar problems. Data structures are prime candidates for this because they are made up of identical structure types, connected together in a way which make them look like programs connected up by function calls.

Recursive functions can be tamed by making sure that there is a safe way exit them, so that recursion only happens under particular circumstances. The aim is to control the number of times that recursion takes place by making a decision about what happens in the function: the decision about whether a function calls itself or not. For example, it is easy to make `Well_Function` recurse four times only, by making a test:

```
Well_Function(nooftimes)

int nooftimes;

{
if (nooftimes == 0)
{
return (0);
}
else
{
Well_Function(nooftimes-1);
}
}
```

A call of `WellFunction(4)` would make this function drop down four stack levels and then return. Notice the way in which the `if..else` statement shields the program from the recursion when `nooftimes` equals zero. It effectively acts as a safety net, stopping the programming from plunging down the level well infinitely.

## 28.4 Simple Example without a Data Structure

A completely standard example of controlled recursion is the factorial (or Gamma) function. This is a mathematical function which is important in statistics. (Mathematicians also deal with recursive functions; computer programs are not alone in this.) The factorial function is defined to be the "product" (multiplication) of all the natural (unsigned integer) numbers from 1 to the parameter of the function. For example:

```
factorial(4) == 1 * 2 * 3 * 4           == 24
factorial(6) == 1 * 2 * 3 * 4 * 5 * 6   == 720
```

Formally, the factorial function is defined by two mathematical statements:

```
factorial (n) = n * factorial(n-1)
```

and

```
factorial (0) = 1
```

The first of these statements is recursive, because it defines the value of `factorial(n)` in terms of the factorial function of  $(n - 1)$ . This strange definition seems to want to lift itself by its very bootstraps! The second statement saves it, by giving it a reference value. The factorial function can be written down immediately, as a controlled recursive function:

```
factorial (n)
unsigned int n;
{
if (n == 0)
{
return (1);
}
else
{
return (n * factorial(n-1));
}
}
```

To see how this works, try following it through for `n` equals three. The statement:

```
factorial (3);
```

causes a call to be made to `factorial()`. The value of `n` is set to three. `factorial()` then tests whether `n` is zero (which it is not) so it takes the

alternative branch of the 'if...else' statement. This instructs it to return the value of:

```
3 * factorial(3-1)
```

In order to calculate that, the function has to call `factorial` recursively, passing the value (3-1) or 2 to the new call. The new call takes this value, checks whether it is zero (it is not) and tries to return the value `2 * factorial(1)`. In order to work this out, it needs to call `factorial` again, which checks that `n` is not 0 (it is not) and so tries to return `1 * factorial(0)`. Finally, it calls `factorial(0)` which does not call `factorial` any more, but starts unloading the stack and returning the values. The expression goes through the following steps before finally being evaluated:

```
factorial (3) == 3 * factorial(2)
              == 3 * (2 * factorial(1))
              == 3 * (2 * (1 * factorial(0)))
              == 3 * (2 * (1 * 1))

              == 3 * 2 * 1 * 1
```

Try to write this function without using recursion and compare the two.

## 28.5 Simple Example With a Data Structure

A data structure earns the name recursive if its structure looks identical at every point within it. The simplest recursive structure is the linked list. At every point in a linked list, there are some data of identical type and one pointer to the next structure. The next simplest structure is the binary tree: this structure splits into two at every point. It has two pointers, one which branches left and one which branches to the right. Neither of these structures goes on for ever, so it seems reasonable to suppose that they might be handled easily using controlled recursive functions.

`deletetoend()` is a function which releases the dynamic memory allocated to a linked list in one go. The problem it faces is this: if it deletes the first structure in the list, it will lose information about where the rest of the list is, because the pointer to the successor of a structure is held in its predecessor. It must therefore make a note of the pointer to the next structure in the list, before it deletes that structure, or it will never be able to get beyond the first structure in the list. The solution is to delete the list backwards from last to first using the following recursive routine.

```
/* structure definition */

struct list
{
    /* some other data members */
    struct list *succ;
};
```

```

/*****

struct list *deletetoend (ptr)

struct list *ptr;

{
if (ptr != NULL)
{
deletetoend (ptr->succ);
releasestruct (ptr);
}
return (NULL);
}

/*****

releasestruct (ptr)          /* release memory back to pool */

struct list *ptr;

{
if (free((char *) ptr) != 0)
{
printf ("DEBUG [ZO/TktDtStrct] memory release failure\n");
}
}
}

```

We supply a pointer to the place we would like the list to end. This need not be the very beginning: it could be any place in the list. The function then eliminates all structures after that point, up to the end of the list. It does assume that the programmer has been careful to ensure that the end of the list is marked by a NULL pointer. This is the conventional way of denoting a pointer which does not point anywhere. If the pointer supplied is already NULL then this function does nothing. If it is not NULL then it executes the statements enclosed by the `if` braces. Notice that `deletetoend()` calls itself immediately, passing its successor in the list as a parameter. (`ptr->succ`) The function keeps doing this until it finds the end on the list. The very last-called `deletetoend()` then reaches the statement `releasestruct()` which frees the memory taken up by the last structure and hands it back to the free memory pool. That function consequently returns and allows the second-last `deletetoend()` to reach the `releasestruct()` statement, releasing the second last structure (which is now on the end of the list). This, in turn, returns and the process continues until the entire list has been deleted. The function returns the value NULL at each stage, so that when called, `deletetoend()` offers a very elegant way of deleting part or all of a linked list:

```

struct list *newlast;

newlast->succ = deletetoend (newlast->succ);

ptr = deletetoend (ptr);

```

newlast then becomes the new end of the list, and its successor is NULLified in a single statement.

## 28.6 Advantages and Disadvantages of Recursion

Why should programmers want to clutter up programs with techniques as mind boggling as recursion at all? The great advantage of recursion is that it makes functions very simple and allows them to behave just like the thing they are attempting to model. Unfortunately there are few situations in which recursion can be employed in a practical way. The major disadvantage of recursion is the amount of memory required to make it work: do not forget that the program stack grows each time a function call is made. If a recursive function buried itself a thousand levels deep, a program would almost certainly run out of memory. There is also the slight danger that a recursive function will go out of control if a program contains bugs.

## 28.7 Recursion and Global Variables

Global variables and recursion do not mix well. Most recursive routines only work because they are sealed capsules and what goes on inside them can never affect the outside world. The only time that recursive functions should attempt to alter global storage is when the function concerned operates on a global data structure, as in the example above. To appreciate the danger, consider a recursive function, in which a second function `alterGLOBAL()` accidentally alters the value of `GLOBAL` in the middle of the function:

```
int GLOBAL = -2;

recursion ()

{
if (++GLOBAL == 0)
{
return (0);
}

alterGLOBAL(); /* another function which alters GLOBAL */
recursion();
}
```

This function is treading a fine line between safety and digging its own recursive grave. If `alterGLOBAL()` makes `GLOBAL` more negative, as fast as `++` can make it more positive then `GLOBAL` will never be able to satisfy the condition of being zero and it will go on making recursive calls, never returning. If `alterGLOBAL()` makes the mistake of setting `GLOBAL` to a positive value, then the `++` operator in `recursion()` can only make `GLOBAL` larger and it will never be able to satisfy the condition that `GLOBAL == 0` and so again the



function would never be able to return. The stack would fill up the memory and the program would plunge down an unending recursive well.

If global variables and parameters are used instead, this difficulty can be controlled much more easily. `alterGLOBAL()` cannot alter a variable in `recursion()` by accident, if only local variables are used, because it only works with its own local copies of parameters and variables which are locked away in a sealed capsule, out of harm's way.

## 28.8 Questions

1. What is a recursive function?
2. What is a program "stack" and what is it for.
3. State the major disadvantage of recursion.



## 29 Example Programs

The aim of this section is to provide two substantial examples of C, which use the data structures described in section 28.

### 29.1 Statistical Data Handler

The first program is a utility which allows the user to type sets of floating point data into an editor and to calculate the mean, standard deviation...and so on, of those data. The program is capable of loading and saving the data to disk, as well as being able to handle several sets of data at once. The editor works in insert or overwrite modes. The program is menu driven and its operation should be reasonably self explanatory, so it is presented with rather sparse documentation.

#### 29.1.1 The Editor

A simple machine independent editor is provided for entering data. The editor first asks the user whether the current number of sets of data is to be altered. The default value is zero so, when data are typed in for the first time, this should be set up, by responding Y for yes. Up to twenty independent sets of data can be used. This number is set at the start and it is held in the memory and saved to disk with data files. If the number of sets is reduced at any time, the top sets are cut off from the calculations, but they are not lost forever, provided the number is changed back to include them before they are saved to disk, since the number of sets is used as an upper bound in a for loop: it does not actually alter the memory. More sets can be added at any time by making this value larger.

#### 29.1.2 Insert/Overwrite

A project file can be edited in either insert mode or overwrite mode. Files which contain no data may only be edited insert mode. The editor senses this and selects the mode automatically. In insert mode the user is prompted for values. Type 0.0 in place of an entry to get out of this mode. In overwrite mode the user is offered each entry in turn. If a non digit character is typed in (such as a '.' (dot) or a '-' (dash) etc..) the value of an entry is not altered. However, if a new value is entered, the new value will replace the old one. By default, the values are offered in turn from 1 to the final value. However, on selecting overwrite mode, the user is prompted for a starting value, and the values are offered from the starting number to the end. This is to avoid the rather tedious process of working through all the entries which are not required in a system independent way.

#### 29.1.3 Quitting Sections

When quitting sections in which the user is supposed to enter data, the convention is that typing a zero value (0.0 for a time, 0 in any other instance)

is a signal to break out of a section. Typing 0.0 while editing in insert mode causes the editor to quit.

#### 29.1.4 The Program Listing

The program includes three library files, which are used for the following purposes.

```
#include <stdio.h>  
    Standard IO eader file
```

```
#include <ctype.h>  
    Contains character ID macros
```

```
#include <math.h>  
    Includes math function declarations
```

The flow of program logic is most easily described by means of a program structure diagram. The diagram shows the structure of function calls within

the program and this can be related to the listing. The general scheme of the program is this:

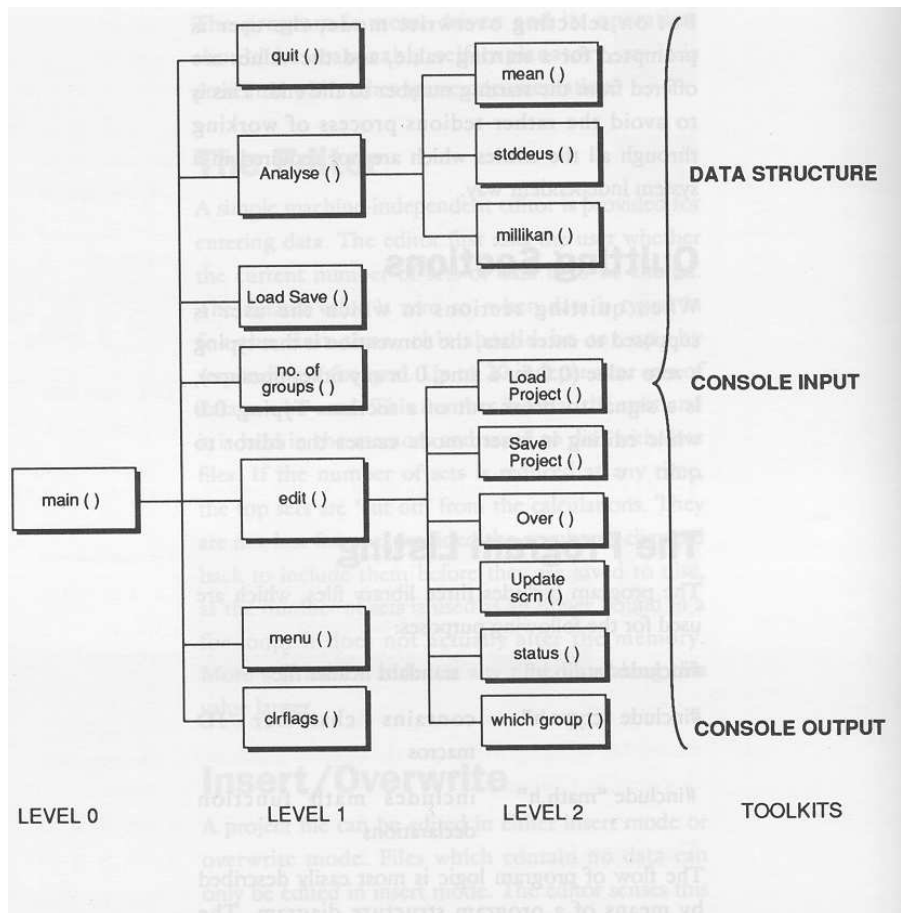

1. Various flags concerning the data structure are cleared.
2. A menu is printed and the program cycles through the menu options.
3. The editor determines the data group to be edited, updates the screen with the data in the current group and loops through insert or overtyping editing until the user quits.
4. The analysis calls custom functions which scan through the data structure calculating the relevant quantities.
5. Various toolkits perform run of the mill activities.

The data structure of this program is an array of linked lists. The array provides the roots of several independent linked lists: one for each group of data. These linked lists are attended to by toolkit routines and by special functions such as `over()`.

## 29.2 Listing

```

/*****
/*
/* Statistical Calculator
/*
/*
*****/

#include <stdio.h>
#include <ctype.h>
#include <math.h>

/*****
** Manifest Constants / Macros / Static Variables
**
*****/

#define TRUE      1
#define FALSE    0
#define GRPS     20 /* No grps which can be handled */
#define CAREFULLY 1
#define FAST     0
#define NOTZERO  1
#define ENDMARK  -1.1
#define NOTENDMARK 0
#define BIGNUM   1e300

int  DATSETS = 0;
short DATATHERE = FALSE; /* list data */
char *FSP = "....."; /* project name */

/*****
** STRUCTURES
**
*****/

struct list
{
    double value;
    struct list *succ;
};

struct Vlist
{
    struct list *datptr;
    int datathere;
}
Data[GRPS];

/*****
** LEVEL 0 : Main Program
**
*****/

```

```

main ()

{ char getkey();

clrflags();

while (TRUE)
{
Menu();
switch (getkey())
{
case '1' : edit(noofgroups());
break;
case '2' : LoadSave();
break;
case '3' : Analyse();
break;
case 'q' : if (wantout(CAREFULLY)) quit();
}
}
}

/*****
** LEVEL 1 **
*****/

clrflags()          /* Initialize a virtual list */

{ short i;

for (i=1; i<=GRPS; i++);
{
Data[i].datathere = FALSE;
Data[i].datptr = NULL;
}
}

/*****

Menu ()

{
CLRSCRN();
printf ("\nStatistical Calculator V1.0\n\n");

printf ("1 : Edit Data Files\n\n");
printf ("2 : Project Files\n\n");
printf ("3 : Analyse Files\n\n");
printf ("q : Quit\n\n");
printf ("\nEnter Choice and RETURN : ");
}
}

```

```

/*****
edit (no_grps)                /* Edit a linked list */

int no_grps;

{ char s,status(),getkey();
  int i,stop = FALSE,ctr;
  void saveproject();
  double over(),t,correct,getfloat();
  struct list *ptr,*here,*eolist(),
              *install(),*startfrom();

while (TRUE)
  {
  i = whichgroup();
  switch (s = status(i))
    {
    case 'i':
      for (here = eolist(i,&ctr); TRUE; ctr++)
        {
          updatescrn (i,s);
          printf("%d:",ctr);
          if ((t = getfloat ()) == 0) break;
          here = install (here,t,i);
        }
      printf ("\n\nFile closed\n\n");
      break;

    case 'o':
      for (ptr=startfrom(&ctr,i); ptr != NULL; ptr = ptr->succ)
        {
          if (ctr % 4 == 1) updatescrn (i,s);
          correct = over(ctr++,ptr->value);
          ptr->value = correct;
        }
      break;

    case 's': saveproject();
              break;
    case 'l': loadproject();
              break;
    case 'q': stop = wantout(FAST);
              }
      if (stop) break;
    }
  }

/*****
noofgroups ()                /* Check no. of data groups */

```



```

{ char ch,getkey();

printf ("Project currently holds %d groups\n\n",DATSETS);
printf ("Alter groups or Edit? (A/E)");

ch = getkey();

switch (tolower(ch))
{
  case 'a' : printf ("\nHow many groups for this file? (0..%d)\n\n",GRPS);
             return (DATSETS = getint(0,GRPS));

  case 'e' : return (DATSETS);
}
}

/*****/

LoadSave ()                /* Project options */

{ char ch,getkey();

CLRSCRN();
printf ("\nCurrent Project %s\n\n", FSP);
printf ("Load new project or Save current one (L/S/Quit) ?\n\n");
ch = getkey();

switch (tolower(ch))
{
  case 'l' : if (sure())
              {
                DATATHERE = loadproject ();
              }
              break;
  case 's' : if (sure())
              {
                saveproject ();
              }
  case 'q' :
}
}

/*****/

Analyse ()                /* Work out some typical quantities */

{ char getkey();
  double mean(), mn, millikan();
  int i;

printf ("Analysis of Data\n\n");

```

```

for (i = 1; i <= DATSETS; i++)
{
    mn = mean(i);
    printf ("Mean value of group %2d : %f\n",i,mn);

    stddevs(mn);

    printf ("Millikan value %d %lg:\n",i,millikan(i));
    NEWLINE();
}

getkey();
}

/*****

quit ()                /* Quit program & tidy */

{ short i;
  struct list *deletetoend();

for (i = 0; i <= DATSETS; i++)
{
    deletetoend (Data[i].datptr);
}

exit(0);
}

/*****
/* LEVEL 2
/*****/

void saveproject ()

{ FILE *dfx;
  char *filename(),ch,getkey();
  struct list *ptr;
  int i;

if ((dfx = fopen (filename(),"w")) == 0)
{
    printf ("Cannot write to file\nPress a key\n");
    ch = getkey();
    return;
}

fprintf (dfx,"%ld\n",DATSETS);

for (i=1; i <= DATSETS; i++)
{
    for (ptr = Data[i].datptr; ptr != NULL; ptr = ptr->succ)

```

```

        {
            fprintf (dfx,"%lf \n",ptr->value);
        }
        fprintf (dfx,"%f\n",ENDMARK);
        fprintf (dfx,"%d\n",Data[i].datathere);
    }

    while (fclose (dfx) != 0)
    {
        printf ("Waiting to close ");
    }

    blankline ();
    return;
}

/*****

loadproject ()          /* Load new list & delete old */

{ FILE *dfx;
  char *filename(),ch,getkey();
  int  r,i;
  double t = 1.0;
  struct list *ptr,*install(),*deletetoend();

if ((dfx = fopen(filename(),"r")) == NULL)
    {
        printf ("File cannot be read\nPress any key\n");
        ch = getkey();
        return (0);
    }

fscanf (dfx,"%ld",&DATSETS);

for (i = 1; i <= DATSETS; i++)
    {
        t = NOTENDMARK;
        Data[i].datptr = deletetoend(Data[i].datptr);
        Data[i].datathere = FALSE;

        for (ptr = Data[i].datptr; t != ENDMARK;)
            {
                fscanf (dfx,"%lf",&t);
                if (t != ENDMARK)
                    {
                        ptr = install (ptr,t,i);
                    }
            }
        fscanf (dfx,"%ld",&r);
        Data[i].datathere = r;
    }

```

```

while (fclose(dfx) != 0)
{
    printf ("Waiting to close file");
}

blankline();
return (TRUE);
}

/*****

whichgroup ()

{ int n = 0;

printf ("\n\nEdit account number: ");
n = getint (0,DATSETS);
if (n == 0)
{
    printf ("Quit!\n");
}

return (n);
}

*****/

char status (i)

int i;

{ char stat;

if (i==0)
{
    stat = 'q';
}
else
{
    if (Data[i].datathere)
    {
        printf ("Insert/Overwrite/Load/Save/Quit?");
        stat = getkey();
        stat = tolower(stat);
    }
    else
    {
        stat = 'i';
    }
}
}

```

```

return (stat);
}

/*****

updatescrn (grp,status)          /* Update editor screen */

int grp;
char status;

{ int ctr=0;
  struct list *ptr;

CLRSCRN();
printf ("\nStatistical Editor V1.0\n\n");
printf ("\nThis project file contains %d groups.\n",DATSETS);

for (ptr = Data[grp].datptr; (ptr != NULL); ptr=ptr->succ)
{
  if ((ctr % 3) == 0) NEWLINE();
  printf (" (%2d) %12g ",ctr+1,(ptr->value));
  ctr++;
}

printf ("\n\nEditing Group %d. Contains %d entries ** ",grp,ctr);

switch (tolower(status))
{
  case 'i' : printf ("INSERT MODE **\n"); break;
  case 'o' : printf ("OVERWRITE MODE **\n");
}

NEWLINE();
}

*****/

double over (n,old)              /* Edit overttype mode */

int n;
double old;

{ double correct = 0;

printf ("Entry %d : ",n);
scanf("%lf",&correct);
skipgarb();

if (correct == 0)
{
  return (old);
}
}

```

```

else
{
    return(correct);
}
}

/*****/

double mean (i)                /* find mean average */

int i;

{ struct list *ptr;
  double sum;
  int num;

sum = num = 0;

for (ptr = Data[i].datptr; ptr != NULL; ptr=ptr->succ)
{
    sum += ptr->value;
    num ++;
}

return (sum/num);
}

/*****/

stddevs (mean,i)              /* find variance/std deviation */

double mean;
int i;

{ double sum,num,var;
  struct list *ptr;

sum = num = 0;

for (ptr = Data[i].datptr; ptr != NULL; ptr=ptr->succ)
{
    sum += (ptr->value - mean) * (ptr->value - mean);
    num ++;
}

var = sum/num;                /* "biased" value */

printf ("Variance %d = %f\n",i,var);
printf ("Std deviation %d = %f\n",i,sqrt(var));
}

/*****/

```

```

double millikan (i) /* smallest diffnce between 2 data */

int i;

{ double temp,record = BIGNUM;
  struct list *ptr1,*ptr2;

for (ptr1 = Data[i].datptr; ptr1 != NULL; ptr1 = ptr1->succ)
  {
  for (ptr2=Data[i].datptr; ptr2!=ptr1; ptr2=ptr2->succ)
  {
  temp = (ptr1->value) - (ptr2->value);
  if (ABS(temp) < record)
  {
  record = ABS(temp);
  }
  }
  }

return(record);
}

/*****
/* LEVEL 3 */
*****/

char *filename ()

{
do
  {
  printf ("Enter filename : ");
  scanf ("%s",FSP);
  skipgarb();
  }

while (strlen(FSP) == 0);
return (FSP);
}

/*****
/* Toolkit data structure */
*****/

struct list *eolist(i,c) /* Seek end of a linked Vlist */

int i,*c;

{ struct list *ptr,*p = NULL;

*c = 1;

```

```

for (ptr = Data[i].datptr; ptr != NULL; ptr = ptr->succ)
{
    ++(*c);
    p = ptr;
}
return (p);
}

/*****

struct list *startfrom (ctr,i) /* Find ith node in list */

int *ctr,i;

{ struct list *ptr,*p = NULL;
  int j = 0;

printf ("Overtpe starting from which entry");
*ctr = getint(1,99);

for (ptr=Data[i].datptr; (ptr != NULL) && (j++ != *ctr); ptr=ptr->succ)
{
    p = ptr;
}

return (p);
}

*****/

struct list *install (ptr,t,i) /* install item at thispos */

struct list *ptr;
double t;
int i;

{ struct list *thispos, *newstruct();

if ((thispos = newstruct()) == NULL)
{
    warning();
    printf ("DEBUG **: Free memory pool is empty");
    exit(0);
}

if (!Data[i].datathere)
{
    Data[i].datptr = thispos;
    Data[i].datathere = TRUE;
}
}
else

```



```

    {
        ptr->succ = thispos;
    }

    thispos->value = t;
    thispos->succ = NULL;

    return (thispos);
}

/*****/

struct list *deletetoend (ptr) /* RECURSIVE WELL - returns
                               NULL for easy deletion of
                               call ptr */

struct list *ptr;

{
    if (ptr != NULL)
    {
        deletetoend (ptr->succ);
        releasestruct (ptr);
    }
    return (NULL);
}

/*****/

struct list *newstruct () /* Allocate space for new item */

{ char *malloc();
  return ((struct list *) malloc(sizeof(struct list)));
}

/*****/

releasestruct (ptr) /* release memory back to pool */

struct list *ptr;

{
    if (free((char *) ptr) != 0)
    {
        printf ("DEBUG [ZO/TktDtStrct] memory release faliure\n");
    }
}

/*****/
/* Toolkit CONSOLE Output */
/*****/

CLRSCRN ()

```

```

{
printf ("\f");
}

/*****

newline ()

{
printf ("\n");
}

/*****

blankline ()

{
printf ("                \r");
}

/*****

warning ()

{
putchar('\7');
}

/*****
/** Toolkit CONSOLE Input **/
*****/

wantout (becareful)          /* Exit from a section */

int becareful;

{
if (becareful)
{
printf ("Really quit? (Y/N)\n");
if (yes()) return (TRUE); else return (FALSE);
}
return (TRUE);
}

/*****

sure (becareful)           /* Are you sure : boolean */

int becareful;

```

```
{
if (becareful)
{
printf ("Are you sure? (Y/N)\n");
if (yes()) return (TRUE); else return (FALSE);
}

return (TRUE);
}

/*****

yes ()                /* boolean response Y/N query */

{
while (TRUE)
{
switch (getkey())
{
case 'y' : case 'Y' : return (TRUE);
case 'n' : case 'N' : return (FALSE);
}
}
}

/*****

char getkey ()        /* get single character */

{ char ch;

scanf ("%c",&ch);
skipgarb();
return (ch);
}

/*****

getint (a,b)         /* return int between a and b */

int a,b;

{ int p, i = a - 1;

for (p=0; ((a > i) || (i > b)); p++)
{
printf ("?");
scanf ("%d",&i);
if (p > 3)
{
skipgarb();
}
}
}
}
```

```

        p = 0;
    }
}
skipgarb();
return (i);
}

/*****

double getfloat ()          /* return long float */

{ double x = 0;

printf ("? ");
scanf ("%lf",&x);
skipgarb();
return (x);
}

/*****

skipgarb()          /* Skip input garbage corrupting scanf */

{
while (getchar() != '\n');
}

        /* end */

```

### 29.3 Variable Cross Referencer

A variable cross referencer is a utility which produces a list of all the identifiers in a C program (variables, macros, functions...) and lists the line numbers of those identifiers within the source file. This is sometimes useful for finding errors and for spotting variables, functions and macros which are never used, since they show up clearly as identifiers which have only a single reference. The program is listed here, with its line numbers, and its

output (applied to itself) is supplied afterwards for reference. The structure diagram illustrates the operation of the program.

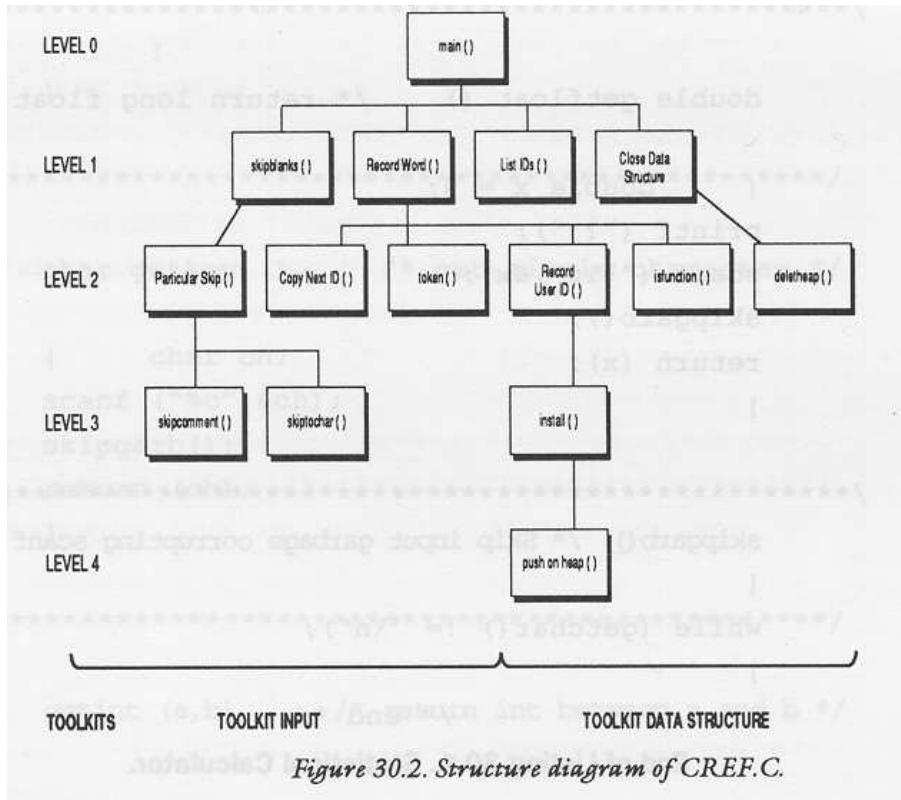

### 29.3.1 Listing Cref.c

```

1 /*****
2 /*
3 /* C programming utility : variable referencer
4 /*
5 /*****
6
7             /* See notes above */
8
9 #include <stdio.h>
10 #include <ctype.h>
11
12 #define TRUE      1
13 #define FALSE    0
14 #define DUMMY    0
15 #define MAXSTR   512
16 #define MAXIDSIZE 32
  
```

```

17 #define WORDTABLE 33
18
19 int LINECOUNT = 1; /* Contains line no. in file */
20 char BUFFER[MAXIDSIZE]; /* Input BUFFER for IDs */
21 char CH; /* Current input character */
22 char SPECIALCHAR; /* macro/pointer flag */
23
24 /*****
25  */
26 /*****
27
28 char *WORDTABLE [WORDTABLE] = /* Table of resvd words */
29
30 {
31     "auto" ,
32     "break" ,
33     "case" ,
34     "char" ,
35     "const",
36     "continue",
37     "default" ,
38     "do" ,
39     "double" ,
40     "else" ,
41     "entry" ,
42     "enum" ,
43     "extern" ,
44     "float" ,
45     "for" ,
46     "goto" ,
47     "if" ,
48     "int" ,
49     "long" ,
50     "register",
51     "return" ,
52     "short" ,
53     "signed" ,
54     "sizeof" ,
55     "static" ,
56     "struct" ,
57     "switch" ,
58     "typedef" ,
59     "union" ,
60     "unsigned",
61     "void" ,
62     "volatile",
63     "while" ,
64 };
65
66 /*****
67  */
68 /*****

```

```
69
70     struct heap
71     {
72         short num;
73         char spec;
74         struct heap *next;
75     };
76
77
78 /*****
79
80     struct BinaryTree
81     {
82         char *name;
83         struct heap *line;
84         struct BinaryTree *left;
85         struct BinaryTree *right;
86     }
87
88     *tree = NULL;
89
90
91 /*****
92 /* LEVEL 0 : main program */
93 /*****
94
95     main ()
96     { FILE *fp;
97       char *filename();
98       struct BinaryTree *CloseDataStruct();
99
100     printf ("\nIdentifier Cross Reference V 1.0\n\n");
101     if ((fp = fopen (filename(),"r")) == NULL)
102     {
103         printf ("Can't read file .. Aborted!\n\n");
104         exit(0);
105     }
106     CH = getc(fp);
107
108     while (!feof(fp))
109     {
110         SkipBlanks (fp);
111         RecordWord (fp);
112     }
113
114     listIDs (tree);
115     CloseDataStruct(tree);
116     printf ("\n%d lines in source file\n",LINECOUNT);
117 }
118
119
120 /*****/
```

```

121 /* LEVEL 1 */
122 /*****/
123
124 SkipBlanks (fp) /* Skip irrelevant characters */
125
126 FILE *fp;
127
128 {
129
130 while (!feof(fp))
131
132 {
133 if (iscsymf(CH))
134 {
135 return(DUMMY);
136 }
137 else
138 {
139 ParticularSkip(fp);
140 }
141 }
142 }
143
144 /*****/
145
146 RecordWord (fp) /* get ID in buffer & tube it to data */
147
148 FILE *fp;
149
150 { int tok;
151
152 CopyNextID (fp);
153
154 if ((tok = token()) == 0) /* if not reserved word */
155 {
156 RecordUserID(isfunction(fp));
157 }
158
159 SPECIALCHAR = ' ';
160 }
161
162 /*****/
163
164 listIDs (p) /* List Binary Tree */
165
166 struct BinaryTree *p;
167
168 { struct heap *h;
169 int i = 0;
170
171 if (p != NULL)
172 {

```



```

173     listIDs (p->left);
174     printf ("\n%-20s",p->name);
175
176     for (h = p->line; (h != NULL); h = h->next)
177     {
178         printf ("%c%-5d",h->spec,h->num);
179         if ((++i % 8) == 0)
180         {
181             printf ("\n          ");
182         }
183     }
184
185     printf ("\n");
186     listIDs (p->right);
187 }
188 }
189
190 /*****
191
192     struct BinaryTree *CloseDataStruct (p)  /* Recursive! */
193
194     struct BinaryTree *p;
195
196     {
197     if (p->left != NULL)
198     {
199         CloseDataStruct(p->left);
200     }
201     else if (p->right != NULL)
202     {
203         CloseDataStruct(p->right);
204     }
205
206     deleteheap(p->line);
207     releasetree(p);
208     return (NULL);
209     }
210
211 /*****
212 /* LEVEL 2 */
213 /*****
214
215     ParticularSkip (fp)  /* handle particular characters */
216
217     FILE *fp;
218
219     { char c;
220
221     switch (CH)
222     {
223     {
224     case '/' : if ((c = getc(fp)) == '*')

```

```

225         {
226         skipcomment (fp);
227         }
228     else
229     {
230         CH = c;
231         return (DUMMY);
232     }
233     break;
234
235     case '"' : if (skiptochar (fp,'"') > MAXSTR)
236     {
237         printf ("String too long or unterminated ");
238         printf ("at line %d\n",LINECOUNT);
239         exit (0);
240     }
241     break;
242
243     case '\\': if (skiptochar (fp,'\\') == 1)
244     {
245         if (CH=='\\') CH = getc(fp);;
246     }
247     break;
248
249     case '#' : skiptochar(fp,' ');
250     SPECIALCHAR = '#';
251     break;
252
253     case '\n': ++LINECOUNT;
254     default : CH = getc(fp);
255     SPECIALCHAR = ' ';
256 }
257 }
258
259 /*****
260
261 CopyNextID (fp)    /* Put next identifier into BUFFER */
262
263 FILE *fp;
264
265 { int i = 0;
266
267 while (!feof(fp) && (iscsym (CH)))
268     {
269     BUFFER[i++] = CH;
270     CH = getc (fp);
271     }
272
273 BUFFER[i] = '\0';
274 }
275
276 /*****/

```

```
277
278 token ()                /* Token: pos in WORDTABLE */
279
280 { int i;
281
282 for (i = 0; i < WORDTABLE; i++)
283 {
284     if (strcmp(&BUFFER[0],WORDTABLE[i]) == 0)
285     {
286         return(i);
287     }
288 }
289 return(0);
290 }
291
292 /*****
293
294 RecordUserID (fnflag) /* check ID type & install data */
295
296 int fnflag;
297
298 { char *strcat();
299     struct BinaryTree *install();
300
301 if (fnflag)
302 {
303     strcat (BUFFER,"()");
304     tree = install (tree);
305 }
306 else
307 {
308     tree = install (tree);
309 }
310 }
311
312 /*****
313
314 isfunction (fp)        /* returns TRUE if ID is a fn */
315
316 FILE *fp;
317
318 {
319 while(!feof(fp))
320 {
321     if (!(CH == ' ' || CH == '\n'))
322     {
323         break;
324     }
325     else if (CH == '\n')
326     {
327         ++LINECOUNT;
328     }

```



```
381     }
382   }
383
384 /*****
385
386   skiptochar (fp,ch)          /* skip to char after ch */
387
388   FILE *fp;
389   char ch;
390
391   { int c=0;
392
393   while (((CH =getc(fp)) != ch) && !feof(fp))
394     {
395       if (CH == '\n')
396         {
397           ++LINECOUNT;
398         }
399       c++;
400     }
401
402   CH = getc(fp);
403   return (c);
404   }
405
406 /*****
407
408   struct BinaryTree *install (p) /* install ID in tree */
409
410   struct BinaryTree *p;
411
412   { struct heap *pushonheap();
413     struct BinaryTree *newtree();
414     char *stringin();
415     int pos;
416
417     if (p == NULL) /* new word */
418       {
419         p = newtree();
420         p->name = stringin(BUFFER);
421         p->line = pushonheap (NULL);
422         p->left = NULL;
423         p->right = NULL;
424         return (p);
425       }
426
427     if ((pos = strcmp (BUFFER,p->name)) == 0) /* found word*/
428       {
429         p->line = pushonheap(p->line);
430         return (p);
431       }
432
```

```

433     if (pos < 0)                                /* Trace down list */
434     {
435         p->left = install(p->left);
436     }
437     else
438     {
439         p->right = install(p->right);
440     }
441
442     return (p);
443 }
444
445 /*****
446  /* LEVEL 4
447  *****/
448
449     struct heap *pushonheap (h) /* push nxt ln no.to heap */
450
451     struct heap *h;
452
453     { struct heap *hp,*newheap();
454
455     hp = newheap();
456     hp->num = LINECOUNT;
457     hp->spec = SPECIALCHAR;
458     hp->next = h;
459
460     return (hp);
461 }
462
463 /*****
464  /* TOOLKIT file input
465  *****/
466
467     backone (ch,fp)                /* backspace one in file */
468
469     char ch;
470     FILE *fp;
471
472     {
473     if (ungetc(ch,fp) != ch)
474     {
475         printf ("\nDebug: Toolkit file input: backone() FAILED\n");
476         exit(0);
477     }
478 }
479
480 /*****
481  /* TOOLKIT stdin
482  *****/
483
484     char *filename ()

```

```

485
486     { static char *fsp = ".....";
487
488     do
489     {
490         printf ("Enter filename of source program: ");
491         scanf ("%33s",fsp);
492         skipgarb ();
493     }
494     while (strlen(fsp) == 0);
495     return (fsp);
496 }
497
498 /*****
499
500     skipgarb ()          /* skip garbage upto end of line */
501
502     {
503         while (getchar() != '\n');
504     }
505
506 /*****
507 /* TOOLKIT data structure          */
508 /*****
509
510     char *stringin (array)    /* cpy str in array to ptr loc*/
511
512     char *array;
513
514     { char *malloc(),*ptr;
515       int i;
516
517       ptr = malloc (strlen(array)+1);
518       for (i = 0; array[i] != '\0'; ptr[i] = array[i++]);
519       ptr[i] = '\0';
520       return(ptr);
521     }
522
523 /*****
524
525     struct heap *newheap ()
526
527     { char *malloc ();
528       return ((struct heap *) malloc(sizeof(struct heap)));
529     }
530
531 /*****
532
533     struct BinaryTree *newtree ()
534
535     { char *malloc ();
536       return ((struct BinaryTree *) malloc(sizeof(struct BinaryTree)));

```

```

537     }
538
539  /******
540
541     releaseheap (ptr)
542
543     struct heap *ptr;
544
545     {
546     if (free((char *) ptr) != 0)
547
548         {
549         printf ("TOOLKIT datastruct: link release failed\n");
550         }
551     }
552
553  /******
554
555     releasetree (ptr)
556
557     struct BinaryTree *ptr;
558
559     {
560     if (free((char *) ptr) != 0)
561
562         {
563         printf ("TOOLKIT datastruct: link release failed\n");
564         }
565     }
566
567                                     /* end */
568

```

### 29.3.2 Output of Cross Referencer

Identifier Cross Reference V 1.0

Enter filename of source program: Cref.c

```

568
BUFFER          427  420  303  284  273  269  20
BinaryTree      557  536  536  533  413  410  408
                299  194  192  166  99   86   85
                82
CH              402  395  393  380  376  370  368
                368  332  329  325  321  321  270

```



	269 133	267 107	254 21	245	245	230	221	
CloseDataStruct()	203	199	192	116	99			
CopyNextID()	261	152						
FILE	470 126	388 97	364	316	263	217	148	
LINECOUNT	456 19	397	372	327	253	238	117	
NULL	423 201	422 197	421 176	417 171	350 102	350 89	208	
ParticularSkip()	215	139						
RecordUserID()	294	156						
RecordWord()	146	112						
SPECIALCHAR	457	255	250	159	22			
SkipBlanks()	124	111						
WORDTABLE	284	28						
WORDTABLE	282	28	#17					
array	518	518	517	512	510			
backone()	467							
c	403	399	391	230	224	219		
ch	473	473	469	467	393	389	386	
cs	380	374	366					
deleteheap()	344	206						
DUMMY	377	231	135	#14				
exit()	476	239	105					
FALSE	338	#13						
feof()	393	368	319	267	130	109		
filename()	484	102	98					

fnflag	301	296	294				
fopen()	102						
fp	473	470	467	402	393	393	388
	386	376	368	368	368	364	362
	329	319	316	314	270	267	263
	261	254	249	245	243	235	226
	224	217	215	156	152	148	146
	139	130	126	124	112	111	109
	107	102	97				
free()	560	546					
fsp	495	494	491	486			
getc()	402	393	376	368	368	329	270
	254	245	224	107			
getchar()	503						
h	458	451	449	354	353	352	350
	348	346	344	178	178	176	176
	176	176	168				
heap	543	528	528	525	453	451	449
	412	348	346	168	84	75	72
hp	460	458	457	456	455	453	
i	519	518	518	518	518	515	286
	284	282	282	282	280	273	269
	265	179	169				
install()	439	435	408	308	304	299	
iscsym()	267						
iscsymf()	133						
isfunction()	314	156					
left	435	435	422	199	197	173	85
line	429	429	421	206	176	84	
listIDs()	186	173	164	115			
main()	95						

malloc()	536	535	528	527	517	514	
MAXIDSIZE	20	#16					
MAXSTR	235	#15					
name	427	420	174	83			
newheap()	525	455	453				
newtree()	533	419	413				
next	458	352	176	75			
num	456	178	73				
p	442	439	439	435	435	430	429
	429	427	424	423	422	421	420
	419	417	410	408	207	206	203
	201	199	197	194	192	186	176
	174	173	171	166	164		
pos	433	427	415				
printf()	563	549	490	475	238	237	185
	181	178	174	117	104	101	
ptr	560	557	555	546	543	541	520
	519	518	517	514			
pushonheap()	449	429	421	412			
releaseheap()	541	353					
releasetree()	555	207					
right	439	439	423	203	201	186	86
scanf()	491						
skipcomment()	362	226					
skipgarb()	500	492					
skiptochar()	386	249	243	235			
spec	457	178	74				
strcat()	303	298					

<code>strcmp()</code>	427	284					
<code>stringin()</code>	510	420	414				
<code>strlen()</code>	517	494					
<code>temp</code>	354	352	350	348			
<code>tok</code>	154	150					
<code>token()</code>	278	154					
<code>tree</code>	308	308	304	304	116	115	89
<code>TRUE</code>	334	#12					
<code>ungetc()</code>	473						
568 lines in source file							

### 29.3.3 Comments

This simplified program could be improved in a number of ways. Here are some suggestions for improvement:

- The program could determine whether an identifier was of type pointer or not and, if so, label the line number with a \*, e.g. \*123 342 \*1234
- At present the program only marks macros with a # symbol on the line at which they are defined. It could be made to mark them at every line, so that #undef-ined symbols and variables were clearly distinguished.

## 30 Errors and debugging

### *Mistakes!*

Debugging can be a difficult process. In many cases compiler errors are not generated because the actual error which was present but because the compiler got out of step. Often the error messages give a completely misleading impression of what has gone wrong. It is useful therefore to build a list of errors and probable causes personally. These few examples here should help beginners get started and perhaps give some insight into the way C works.

### 30.1 Compiler Trappable Errors

#### 30.1.1 Missing semicolon;

A missing semicolon is easily trapped by the compiler. Every statement must end with a semi colon. A compound statement which is held in curly braces seldom needs a semi colon to follow.

```
    statement;  
but:  
    {  
}; <-- This semi colon is only needed if the curly  
      braces enclose a type declaration or an  
      initializer for static array/structure etc.
```

#### 30.1.2 Missing closing brace }

This error is harder to spot and may cause a whole host of irrelevant and incorrect errors after the missing brace. Count braces carefully. One way to avoid this is to always fill braces in before the statements are written inside them. So write

```
{  
  
}
```

and fill in the statements afterwards. Often this error will generate a message like 'unexpected end of file' because it is particularly difficult for a compiler to diagnose.

#### 30.1.3 Mistyping Upper/Lower Case

C distinguishes between small and capital letters. If a program fails at the linking stage because it has found a reference to a function which had not been defined, this is often the cause.

### 30.1.4 Missing quote "

If a quote is missed out of a statement containing a string then the compiler will usually signal this with a message like:

```
String too long or unterminated.
```

### 30.1.5 Variable not declared or scope wrong

This means that a variable is used which has not first been declared, or that a variable is used outside of its sealed capsule.

### 30.1.6 Using a function or assignment inside a macro

If `abs (x)` is a macro and not a function then the following are incorrect:

```
abs (function());
abs (x = function());
```

Only a single variable can be substituted into a macro. This error might generate something like "lvalue required".

### 30.1.7 Forgetting to declare a function which is not type int

All functions return values of `int` by default. If it is required that they return another type of variable, this must be declared in two places: a) in the function which calls the new function, along with the other declarations:

```
CallFunction ()
{ char ch, function1(), *function2();
}
}
```

The `function1()` is type `char`; `function2()` is type pointer to `char`. This must also be declared where the function is defined:

```
char function1 ()
{
}
```

and

```
char *function2()
{
}
```

This error might result in the message "type mismatch" or "external variable/function type/attribute mismatch"

### 30.1.8 Type mismatch in expressions

There is a rule in C that all maths operations have to be performed with long variables. These are

```
int
long int

double
long float
```

The result is also a long type. If the user forgets this and tries to use short C automatically converts it into long form. The result cannot therefore be assigned to a short type afterwards or the compiler will complain that there is a type mismatch. So the following is wrong:

```
short i,j = 2;

i = j * 2;
```

If a short result is required, the cast operator has to be used to cast the long result to be a short one.

```
short i,j = 2;

i = (short) j * 2;
```

## 30.2 Errors not trappable by a compiler (run time errors)

### 30.2.1 Confusion of = and ==

A statement such as:

```
if (a = 0)
{
}
```

is valid C, but notice that = is the assignment operator and not the equality operator ==. It is legal to put an assignment inside the if statement (or any other function) and the value of the assignment is the value being assigned! So writing the above would always give the result zero (which is 'FALSE' in C) so the contents of the braces {} would never be executed. To compare a to zero the correct syntax is:

```
if (a == 0)
```

```
{
}
```

### 30.2.2 Missing & in scanf

This error can often be trapped by a compiler, but not in all cases. The arguments of the scanf statement must be pointers or addresses of variables, not the contents of the variables themselves. Thus the following is wrong:

```
int i;
char ch;

scanf ("%c %d",ch,i);
```

and should read:

```
int i;
char;

scanf ("%c %d", &ch, &i);
```

Notice however that the ‘&’ is not always needed if the identifier in the expression is already a pointer. The following is correct:

```
int *i;
char *ch;

scanf ("%c %d", ch, i);
```

Including the & now would be wrong. If this error is trappable then it will be something like "Variable is not a pointer".

### 30.2.3 Confusing C++ and ++C

In many cases these two forms are identical. However, if they are hidden inside another statement e.g.

```
array [C++] = 0;
```

then there is a subtle difference. ++C causes C to be incremented by 1 before the assignment takes place whereas C++ causes C to be incremented by 1 after the assignment has taken place. So if you find that a program is out of step by 1, this could be the cause.

### 30.2.4 Unwarranted assumptions about storage

C stores arrays in rows, and as far as the language is concerned the storage locations are next to one another in one place up to the end of the array. This might not be exactly true, in general. A program will be loaded into one or more areas (where ever the operating system can find space) and



new variable space will be found wherever it is available, but this will not generally be in whole blocks 'side by side' in the memory. The following sort of construction only works for simple data types:

```
char array[10];

*array = 0;
*(array + 1) = 0;
...
*(array + 10) = 0;
```

While it is true that the variable "array" used without its square brackets is a pointer to the first element of the array, it is not necessarily true that the array will necessarily be stored in this way. Using:

```
char array[10];

array[0] = 0;
array[1] = 0;
...
array[10] = 0;
```

is safe. When finding a pointer to, say, the third element, you should not assume that

```
array + 3 * sizeof (datatype)
```

will be the location. Use:

```
&(array[3])
```

Do not assume that the size of a structure is the sum of the sizes of its parts! There may be extra data inside for operating system use or for implementation reasons, like aligning variables with particular addresses.

### 30.2.5 The number of actual and formal parameters does not match

This problem can be avoided in ANSI C and C++ but not in K&R C. When passing values to a function the compiler will not spot whether you have the wrong number of parameters in a statement, provided they are all of the correct type. The values which are assumed for missing parameters cannot be guaranteed. They are probably garbage and will most likely spoil a program.

### 30.2.6 The conversion string in `scanf/printf` is wrong

Incorrect I/O is can be the result of poorly matched conversion strings in I/O statements. These are wrong:

```

float x;
scanf ("%d",&x);

```

*should be*

```

float x;
scanf ("%f",&x);

```

or even:

```

double x;
scanf ("%f",&x);

```

*should perhaps be*

```

float x;
scanf ("%ld",&x);

```

Another effect which can occur if the conversion specifier is selected as being long when it the variable is really short is that neighbouring variables can receive the `scanf` values instead! For instance if two variables of the same type happen to be stored next to each other in the memory:

```
short i,j;
```

which might look like:

```

-----
|           |           |
-----
          i           j

```

and the user tries to read into one with a long int value, `scanf` will store a long int value, which is the size of two of these `short` variables. Suppose the left hand box were `i` and the right hand box were `j` and you wanted to input the value of `i`: instead of getting:

```

-----
| 002345 |           |
-----
          i           j

```

`scanf` might store

```
000000000000000002345
```

as

```

-----
| 000000000 | 0000002345 |
-----
          i           j

```

because the value was long, but this would mean that the number would overflow out of `i` into `j` and in fact `j` might get the correct value and `i` would be set to zero!! Check the conversion specifiers!!

### 30.2.7 Accidental confusion of `int`, `short` and `char`

Often when working with characters one also wants to know their ASCII values. If characters/integers are passed as parameters it is easy to mistype `char` for `int` etc.. The compiler probably won't notice this because no conversion is needed between `int` and `char`. Characters are stored by their ASCII values. On the other hand if the declaration is wrong:

```
function (ch)
int (ch);
{
}
```

but the character is continually assumed to be a character by the program, a crashworthy routine might be the result.

### 30.2.8 Arrays out of bounds

C does not check the limits of arrays. If an array is sized:

```
type array[5];
```

and then you allow the program to write to `array[6]` or more, C will not complain. However the computer might! In the worst case this could cause the program to crash.

### 30.2.9 Mathematical Error

C does not necessarily signal mathematical errors. A program might continue regardless of the fact that a mathematical function failed. Some mathematical errors (often subtle ones) can be caused by forgetting to include the file `'math.h'` at the start of the program.

### 30.2.10 Uncoordinated Output using buffered I/O

Output which is generated by functions like `putchar()`, `puts()` is buffered. This means that it is not written to the screen until the buffer is either full or is specifically emptied. This results in strange effects such as programs which produce no output until all the input is complete (short programs) or spontaneous bursts of output at uncoordinated intervals. One cure is to terminate with a newline `'\n'` character which flushes the buffers on each write operation. Special functions on some systems such as `getch()` may also suffer from this problem. Again the cure is to write:

```
printf ("\n");
```

```
ch = getch();
```

### 30.2.11 Global Variables and Recursion

Global variables and recursion should not be mixed. Most recursive routines work only because they are sealed capsules and what goes on inside them can never affect the outside world. The only time that recursive functions should alter global storage is when the function concerned operates on a global data structure. Consider a recursive function:

```
int GLOBAL;

recursion ()

{
  if (++GLOBAL == 0)
  {
    return (0);
  }

  alterGLOBAL(); /* another function which alters GLOBAL */
  recursion();
}
```

This function is treading a fine line between safety and digging its own recursive grave. All it would take to crash the program, would be the careless use of `GLOBAL` in the function `alterGLOBAL()` and the function would never be able to return. The stack would fill up the memory and the program would plunge down an unending recursive well.

## 30.3 Tracing Errors

### 30.3.1 Locating a problem

Complex bugs can be difficult to locate. Here are some tips for fault finding:

1. Try to use local variables, in preference to global ones for local duties. Never rely on global variables for passing messages between functions.
2. Check variable declarations and missing parameters.
3. Check that a program has not run out of private memory. (If it repeatedly crashes for no apparent reason, this could be a cause.) Make the program stack size bigger if that is possible.
4. Use statements like `printf("program is now here")` to map out the progress of a program and to check that all function calls are made correctly.
5. Use statements like `ch = getchar()` to halt a program in certain places and to find out the exact location at which things go wrong.

6. Try "commenting out" lines of suspect code. In other words: put comment markers around lines that you would like to eliminate temporarily and then recompile to pinpoint errors.
7. Check that the compiler disk has not been corrupted (make a new copy) – getting desperate now!
8. Try retyping the program, or using a filter which strips out any illegal characters which might have found their way into a program.
9. Get some sleep! Hope the problem has gone away in the morning.

Failing these measures, try to find someone who programs in C regularly on the computer system concerned.

## 30.4 Pathological Problems

Problems which defy reasonable explanations are called pathological or 'sick'. Sometimes these will be the result of misconceptions about C functions, but occasionally they may be the result of compiler bugs, or operating system design peculiarities. Consider the following example which was encountered while writing the simple example in the chapter on Files and Devices, sub-section 'Low Level File Handling': in that program a seemingly innocent macro defined by

```
#define CLRSCRN() putchar('\f');
```

caused the C library functions `creat()` and `remove()` to fail is remarkable ways on an early Amiga C compiler! The problem was that a single call to `CLRSCRN()` at the start of the function `DelFile()` caused both of the library functions (in very different parts of the program) above to make recursing function calls the function `DelFile()`. The deletion of `CLRSCRN()` cured the problem entirely! In general it is worth checking carefully the names of all functions within a program to be sure that they do not infringe upon library functions. For example, `read()` and `write()` are names which everyone wishes to use at some point, but they are the names of standard library functions, so they may not be used. Even capitalizing (`Read()` / `Write()`) might not work: beware that special operating system libraries have not already reserved these words as library commands.

It is almost impossible to advise about these errors. A programmer can only hope to try to eliminate all possibilities in homing in on the problem. To misquote Sherlock Holmes: "At the end of the day, when all else fails and the manuals are in the waste paper basket, the last possibility, however improbable, has to be the truth."

## 30.5 Porting Programs between computers

Programs written according to the style guidelines described in this book should be highly portable. Nevertheless, there are almost inevitably problems in porting programs from one computer to another. The most likely

area of incompatibility between compilers regards filing operations, especially `scanf()`. Programmers attempting to transfer programs between machines are recommended to look at all the `scanf()` statements first and to check all the conversion specifiers with a local compiler manual. `scanf()` is capable of producing a full spectrum of weird effects which have nothing to do with I/O. Here are some more potential problems to look out for:

- Assumptions about the size of data objects such as `int` and `float` can be risky.
- Check conversion characters in `printf()` and `scanf()` as some compilers choose slightly different conventions for these.
- The stack size for (memory available to) a program is likely to vary between systems. This can cause errors at run time if a program runs out of space, even though there is nothing wrong with the code.
- Check for functions which rely on the speed of a particular computer. For example, `pause()` or wait loops. Some computers may scarcely notice counting to 50000, whereas others may labour at it for some time!
- Check for assumptions made about filenames. e.g. limited/unlimited size, valid characters etc..

## 30.6 Questions

Spot the errors in the following:

1.

```
function (string,i)
{
char *string;
int i;

}
```

2.

```
while (a < b)
{
while (b == 0)
{
printf ("a is negative");
}
```

3.

```
struct Name
{
int member1;
int member2;
```

3





## 31 Summary of C

### 31.1 Reserved Words

<b>auto</b>	storage class specifier (declaration)
<b>break</b>	statement (escape from switch or loop)
<b>case</b>	option prefix within switch statement
<b>char</b>	typename
<b>continue</b>	statement (branch to start of next loop)
<b>default</b>	option in switch statement
<b>do</b>	statement
<b>double</b>	typename
<b>else</b>	statement
<b>entry</b>	(reserved for the future use)
<b>extern</b>	storage class specifier
<b>float</b>	typename
<b>for</b>	statement
<b>goto</b>	goto label
<b>if</b>	statement
<b>int</b>	typename
<b>long</b>	typename
<b>register</b>	storage class specifier
<b>return</b>	functional statement
<b>short</b>	typename
<b>sizeof</b>	compile time operator
<b>static</b>	storage class specifier
<b>struct</b>	partial typename
<b>switch</b>	statement
<b>typedef</b>	statement
<b>union</b>	partial typename
<b>unsigned</b>	typename
<b>while</b>	statement

`enum` partial typename: ordinal types only  
`void` typename  
`const` storage class specifier(no storage allocated)  
`signed` typename  
`volatile` storage class specifier

## 31.2 Preprocessor Directives

`#include` include file for linking  
`#define` define a preprocessor symbol/macro  
`#undef` un-define a previously defined symbol  
`#if` test for conditional compilation  
`#ifdef` (ditto)  
`#ifndef` (ditto)  
`#else` (ditto)  
`#endif` (ditto)  
`#line` debug tool  
`#error` debug tool

## 31.3 Header Files and Libraries

Header files contain macro definitions, type definitions and variable/ function declarations which are used in connection with standard libraries. They supplement the object code libraries which are linked at compile time for standard library functions. Some library facilities are not available unless header files are included. Typical names for header files are:

'`stdio.h`' Standard I/O (libc).  
'`ctype.h`' Macro for character types.  
'`math.h`' Mathematical definitions (libm)

## 31.4 Constants

*Integer* Characters 0..9 only  
*Octal* Prefix 0 (zero) chars 0..7 only  
*Hexadecimal*  
Prefix 0x (zero ex) chars a..f A..F 0..9

*Explicit Long*

Integer/Octal or Hexadecimal types can be declared long by writing L immediately after the constant.

*Character* Declared in single quotes e.g. 'x' '\n'

*Float* Characters 0..0 and one "." May also use scientific notation exponents with e or E preceding them. e.g. 2.14E12 3.2e-2

*Strings* String constants are written in double quotes e.g. "This is a string" and have type pointer to character.

## 31.5 Primitive Data Types

char	Holds any character
int	Integer type
short int	Integer no larger than int
long int	Integer no smaller than int
float	Floating point (real number)
long float	Double precision float
double	(ditto)
void	Holds no value, uses no storage (except as a pointer)

## 31.6 Storage Classes

auto	Local variable (redundant keyword)
const	No variable allocated, value doesn't change
extern	Variable is defined in another file
static	Value is preserved between function calls
register	Stored in a register, if possible
volatile	Value can be changed by agents outside the program.

## 31.7 Identifiers

Identifiers may contain the characters: 0..9, A..Z, a..z and \_ (the underscore character). Identifiers may not begin with a number. (The compiler assumes that an object beginning with a number is a number.)

## 31.8 Statements

A single statement is any valid string in C which ends with a semi colon. e.g.

```
a = 6;
printf ("I love C because...");
```

A compound statement is any number of single statements grouped together in curly braces. The curly braces do not end with a semi colon and stand in place of a single statement. Any pair of curly braces may contain local declarations after the opening brace. e.g.

```
{
a = 6;
}

{ int a;

a = 6;
printf ("I love C because...");
}
```

### Summary of Operators and Precedence

The highest priority operators are listed first.

<i>Operator</i>	<i>Operation</i>	<i>Evaluated</i>
()	parentheses	left to right
[]	square brackets	left to right
++	increment	right to left
--	decrement	right to left
(type)	cast operator	right to left
*	the contents of	right to left
&	the address of	right to left
-	unary minus	right to left
~	one's complement	right to left
!	logical NOT	right to left
*	multiply	left to right
/	divide	left to right
%	remainder (MOD)	left to right
+	add	left to right
-	subtract	left to right
>>	shift right	left to right
<<	shift left	left to right
>	is greater than	left to right
>=	greater than or equal to	left to right

<=	less than or equal to	left to right
<	less than	left to right
==	is equal to	left to right
!=	is not equal to	left to right
&	bitwise AND	left to right
^	bitwise exclusive OR	left to right
	bitwise inclusive OR	left to right
&&	logical AND	left to right
	logical OR	left to right
=	assign	right to left
+=	add assign	right to left
-=	subtract assign	right to left
*=	multiply assign	right to left
/=	divide assign	right to left
%=	remainder assign	right to left
>>=	right shift assign	right to left
<<=	left shift assign	right to left
&=	AND assign	right to left
^=	exclusive OR assign	right to left
=	inclusive OR assign	right to left

## 31.9 Character Utilities

```
char ch;
```

```
isalpha(ch)
```

Is alphabetic a..z A..Z

```
isupper(ch)
```

Is upper case

```
islower(ch)
```

Is lower case

```
isdigit(ch)
```

Is in the range 0..9

```
isxdigit(ch)
```

Is 0..9 or a..f or A..F

```
isspace(ch)
```

Is white space character (space/newline/tab)

```
ispunct(ch)
```

Is punctuation or symbolic

```
isalnum(ch)
```

Is alphanumeric (alphabetic or number)

<code>isprint(ch)</code>	Is printable on the screen (and space)
<code>isgraph(ch)</code>	If the character is printable (not space)
<code>iscntrl(ch)</code>	Is a control character (not printable)
<code>isascii(ch)</code>	Is in the range 0..127
<code>iscsym(ch)</code>	Is a valid character for a C identifier
<code>toupper(ch)</code>	Converts character to upper case
<code>tolower(ch)</code>	Converts character to lower case
<code>toascii(ch)</code>	Converts character to ascii (masks off top bit)

### 31.10 Special Control Characters

Control characters are invisible on the screen. They have special purposes usually to do with cursor movement and are written into an ordinary string or character by typing a backslash character `\` followed by some other character. These characters are listed below.

<code>'\b'</code>	backspace BS
<code>'\f'</code>	form feed FF (also clear screen)
<code>'\n'</code>	new line NL (like pressing return)
<code>'\r'</code>	carriage return CR (cursor to start of line)
<code>'\t'</code>	horizontal tab HT
<code>'\v'</code>	vertical tab (not all versions)
<code>'\"'</code>	double quotes (not all versions)
<code>'\''</code>	single quote character <code>'</code>
<code>'\\'</code>	backslash character <code>\</code>
<code>'\ddd'</code>	character <i>ddd</i> where <i>ddd</i> is an ASCII code given in octal or base 8. (See Appendix C)

## 31.11 Input/Output Functions

<code>printf ()</code>	Formatted printing
<code>scanf ()</code>	Formatted input analysis
<code>getchar()</code>	Get one character from stdin file buffer
<code>putchar()</code>	Put one character in stdout file buffer
<code>gets ()</code>	Get a string from stdin
<code>puts ()</code>	Put a string in stdout
<code>fprintf()</code>	Formatted printing to general files
<code>fscanf()</code>	Formatted input from general files
<code>fgets()</code>	Get a string from a file
<code>fputs()</code>	Put a string in a file
<code>fopen()</code>	Open/create a file for high level access
<code>fclose()</code>	Close a file opened by <code>fopen()</code>
<code>getc()</code>	Get one character from a file (macro?)
<code>ungetc();</code>	Undo last get operation
<code>putc()</code>	Put a character to a file (macro?)
<code>fgetc()</code>	Get a character from a file (function)
<code>fputc()</code>	Put a character from a file (function)
<code>feof()</code>	End of file . returns true or false
<code>fread()</code>	Read a block of characters
<code>fwrite()</code>	Write a block of characters
<code>ftell()</code>	Returns file position
<code>fseek()</code>	Finds a file position
<code>rewind()</code>	Moves file position to the start of file
<code>fflush()</code>	Empties file buffers
<code>open()</code>	Open a file for low level use
<code>close()</code>	Close a file opened with <code>open()</code>
<code>creat()</code>	Create a new file

`read()` Read a block of untranslated bytes  
`write()` Write a block of untranslated bytes  
`rename()` Rename a file  
`unlink()` Delete a file  
`remove()` Delete a file  
`lseek()` Find file position

### 31.12 printf conversion specifiers

`d` signed denary integer  
`u` Unsigned denary integer  
`x` Hexadecimal integer  
`o` Octal integer  
`s` String  
`c` Single character  
`f` Fixed decimal floating point  
`e` Scientific notation floating point  
`g` Use `f` or `e`, whichever is shorter

The letter 'l' (ell) can be prefixed before these for long types.

### 31.13 scanf conversion specifiers

The conversion characters for `scanf` are not identical to those for `printf` and it is important to distinguish the long types here.

`d` Denary integer  
`ld` Long int  
`x` Hexadecimal integer  
`o` Octal integer  
`h` Short integer  
`f` Float type  
`lf` Long float or double  
`e` Float type  
`le` Double  
`c` Single character  
`s` Character string



## 31.14 Maths Library

These functions require double parameters and return double values unless otherwise stated. It is important to include `'math.h'`.

<code>ABS(x)</code>	Return absolute (unsigned) value. (macro)
<code>fabs(x)</code>	Return absolute (unsigned) value. (Function)
<code>ceil(x)</code>	Rounds up a "double" variable
<code>floor(x)</code>	Rounds down (truncates) a "double" variable.
<code>exp(x)</code>	Find exponent
<code>log(x)</code>	Find natural logarithm
<code>log10(x)</code>	Find logarithm to base 10
<code>pow(x,y)</code>	Raise x to the power y
<code>sqrt(x)</code>	Square root
<code>sin(x)</code>	Sine of (x in radians)
<code>cos(x)</code>	Cosine of (x in radians)
<code>tan(x)</code>	Tangent of (x in radians)
<code>asin(x)</code>	Inverse sine of x in radians
<code>acos(x)</code>	Inverse cosine of x in radians
<code>atan(x)</code>	Inverse tangent of x in radians
<code>atan2(x,y)</code>	Inverse tangent of x/y in radians
<code>sinh(x)</code>	Hyperbolic sine
<code>cosh(x)</code>	Hyperbolic cosine
<code>tanh(x)</code>	Hyperbolic tangent

## 31.15 goto

This word is redundant in C and encourages poor programming style. For this reason it has been ignored in this book. For completeness, and for those who insist on using it (may their programs recover gracefully) the form of the goto statement is as follows:

```
goto label;
```

`label` is an identifier which occurs somewhere else in the given function and is defined as a label by using the colon:

```
label : printf ("Ugh! You used a goto!");
```



## Appendix A All the Reserved Words

Here is a list of all the reserved words in C. The set of reserved words above is used to build up the basic instructions of C; you can not use them in programs your write

Please note that this list is somewhat misleading. Many more words are out of bounds. This is because most of the facilities which C offers are in libraries that are included in programs. Once a library has been included in a program, its functions are defined and you cannot use their names yourself.

C requires all of these reserved words to be in lower case. (This does mean that, typed in upper case, the reserved words could be used as variable names, but this is not recommended.)

(A "d" by the word implies that it is used as part of a declaration.)

auto d	if
break	int d
case	long d
char d	register d
continue	return
default	short d
do	sizeof
double d	static d
else	struct
entry	switch
extern d	typedef d
float d	union d
for	unsigned d
goto	while

*also in modern implementations:*

enum d
void d
const d
signed d
volatile d



## Appendix B Three Languages: Words and Symbols Compared

If you are already familiar with Pascal (Algol..etc) or BBC BASIC, the following table will give you a rough and ready indication of how the main words and symbols of the three languages relate.

C	Pascal	BASIC
=	:=	=
==	=	=
*,/	*,/	*,/
/,%	div, mod	DIV, MOD

<code>printf ("..");</code>	<code>writeln ('..'); write ('..');</code>	<code>PRINT ".."</code>
<code>scanf ("..",a);</code>	<code>readln (a); read (a);</code>	<code>INPUT a</code>
<code>for (x = ..;...;) {  }</code>	<code>for x := ...to begin  end;</code>	<code>FOR x = ...  NEXT x</code>
<code>while (..) { }</code>	<code>while ...do begin end;</code>	<code>N/A</code>
<code>do { } while (..);</code>	<code>N/A</code>	<code>N/A</code>
<code>N/A</code>	<code>repeat until (..)</code>	<code>REPEAT UNTIL ..</code>
<code>if (..) ...; else ...;</code>	<code>if ... then ... else ..;</code>	<code>IF .. THEN.. ELSE</code>
<code>switch (..) {   case : }</code>	<code>case .. of  end;</code>	<code>N/A</code>
<code>/* .... */</code>	<code>{ ..... }</code>	<code>REM .....</code>
<code>*</code>	<code>^</code>	<code>? ! \$</code>
<code>struct</code>	<code>record</code>	<code>N/A</code>
<code>union</code>	<code>N/A</code>	<code>N/A</code>

The conditional expressions `if` and `switch` are essentially identical to Pascal's own words `if` and `case` but there is no redundant "then". BASIC has no analogue of the `switch` construction. The loop constructions of C are far superior to those of either BASIC or Pascal however. Input and Output in C is more flexible than Pascal, though correspondingly less robust in terms of program crashability. Input and Output in C can match all of BASIC's string operations and provide more, though string variables can be more awkward to deal with.

## Appendix C Character Conversion Table

This table lists the decimal, octal, and hexadecimal numbers for characters 0 – 127.

Decimal	Octal	Hexadecimal	Character
0	0	0	CTRL-@
1	1	1	CTRL-A
2	2	2	CTRL-B
3	3	3	CTRL-C
4	4	4	CTRL-D
5	5	5	CTRL-E

6	6	6	CTRL-F
7	7	7	CTRL-G
8	10	8	CTRL-H
9	11	9	CTRL-I
10	12	A	CTRL-J
11	13	B	CTRL-K
12	14	C	CTRL-L
13	15	D	CTRL-M
14	16	E	CTRL-N
15	17	F	CTRL-O
16	20	10	CTRL-P
17	21	11	CTRL-Q
18	22	12	CTRL-R
19	23	13	CTRL-S
20	24	14	CTRL-T
21	25	15	CTRL-U
22	26	16	CTRL-V
23	27	17	CTRL-W
24	30	18	CTRL-X
25	31	19	CTRL-Y
26	32	1A	CTRL-Z
27	33	1B	CTRL-[
28	34	1C	CTRL-\
29	35	1D	CTRL-]
30	36	1E	CTRL-^
31	37	1F	CTRL-_
32	40	20	
33	41	21	!
34	42	22	"
35	43	23	#
36	44	24	\$
37	45	25	%
38	46	26	&
39	47	27	'
40	50	28	(
41	51	29	)
42	52	2A	*
43	53	2B	+
44	54	2C	,
45	55	2D	-
46	56	2E	.
47	57	2F	/
48	60	30	0
49	61	31	1
50	62	32	2
51	63	33	3
52	64	34	4
53	65	35	5
54	66	36	6
55	67	37	7
56	70	38	8
57	71	39	9
58	72	3A	:
59	73	3B	;
60	74	3C	<
61	75	3D	=
62	76	3E	>
63	77	3F	?
64	100	40	@
65	101	41	A
66	102	42	B
67	103	43	C
68	104	44	D
69	105	45	E
70	106	46	F
71	107	47	G
72	110	48	H
73	111	49	I
74	112	4A	J
75	113	4B	K
76	114	4C	L
77	115	4D	M
78	116	4E	N



## Appendix D Emacs style file

The programming style used in this book can be taught to Emacs with the following site-lisp file:

```

;;;
;;; C, perl and C++ indentation, Burgess style. (Thomas Sevaldrud)
;;;

(defconst burgess-c-style
  '(c-tab-always-indent . t)
  (c-hanging-braces-alist . ((substatement-open before after)
    (brace-list-open)))
  (c-hanging-colons-alist . ((member-init-intro before)
    (inher-intro)
    (case-label after)
    (label after)
    (access-label after)))
  (c-cleanup-list . (scope-operator))
  (c-offsets-alist . ((arglist-close . c-lineup-arglist)
    (defun-block-intro . 1)
    (substatement-open . 3)
    (statement-block-intro . 0)
    (topmost-intro . -1)
    (case-label . 0)
    (block-open . 0)
    (knr-argdecl-intro . -)))

  ;(c-echo-syntactic-information-p . t)
  )
  "Burgess Programming Style")

;; Customizations for all of c-mode, c++-mode, and objc-mode
(defun burgess-c-mode-common-hook ()
  ;; add my personal style and set it for the current buffer
  (c-add-style "BURGESS" burgess-c-style t)
  ;; offset customizations not in burgess-c-style
  (c-set-offset 'member-init-intro '++)
  ;; other customizations
  ;; keybindings for C, C++, and Objective-C. We can put these in
  ;; c-mode-map because c++-mode-map and objc-mode-map inherit it
  (define-key c-mode-map "\C-m" 'newline-and-indent)
  )
  (add-hook 'c-mode-common-hook 'burgess-c-mode-common-hook)

;;;
;;; Lite hack for slippe skrive inn kompileringskommandoen i c,
;;; (hvis ikke Makfile eksisterer)
;;; samt en fancy heading hvis det er en ny fil.

```



```

    /* Description:
    /*" (make-string 75 ? ) "*/\n"
    /*" (make-string 75 ?=) "*/\n"
    /*
    /*" (make-string 75 ?=) "*/\n"
    "\n#include <iostream.h>\n"))))
    (outline-minor-mode 1)
    (or (file-exists-p "makefile")
        (file-exists-p "Makefile"))
    (set (make-local-variable 'compile-command)
         (concat "g++ -o "
                 (substring
                  (file-name-nondirectory buffer-file-name)
                  0
                  (string-match
                   "\\\.C$"
                   (file-name-nondirectory buffer-file-name)))
                 " "
                 (file-name-nondirectory buffer-file-name))))))

;;; Mark hacks

( setq perl-mode-hook

  '(lambda()
    (setq perl-indent-level 0)
    (setq perl-continued-statement-offset 3)
    (setq perl-continued-brace-offset -3)
    (setq perl-brace-offset 3)
    (setq perl-brace-imaginary-offset 0)
    (setq perl-label-offset -3)
    (define-key perl-mode-map "\C-m" 'newline-and-indent)
  )

)

( setq java-mode-hook

  '(lambda()
    (setq java-indent-level 0)
    (setq java-continued-statement-offset 3)
    (setq java-continued-brace-offset -4)
    (setq java-brace-offset 3)
    (setq java-brace-imaginary-offset 0)
    (setq java-label-offset -4)
    (setq java-statement-block-intro . +)
    (setq java-kr-argdecl-intro . 3)
    (setq java-substatement-open . 0)
    (setq java-label . 0)
  )
)

```

```
(setq java-statement-case-open . 0)
(setq java-statement-cont      . 0)

(define-key java-mode-map "\C-m" 'newline-and-indent)
)

)
```

## Appendix E Answers to questions

### Chapter 1

- 1) A tool which translates high level language into machine language.
- 2) By typing the name of an executable file.
- 3) By typing something like "cc filename"
- 4) NO!
- 5) Compiler errors and runtime errors.

### Chapter 3

- 1) `printf ("Wow big deal");`
- 2) `printf ("22");`
- 3) `printf ("The 3 wise men");`  
`printf ("The %d wise men",3);`
- 4) Most facilities are held in libraries

### Chapter 4

- 1) To provide a basic set of facilities to the user
- 2) The filename used by a computer to reference a device
- 3) `accounts.c`
- 4) `accounts.x` (or perhaps `accounts.EXE`)
- 5) By typing the name in 4)

### Chapter 5

- 1) `#include <filename>` or `#include "filename"`
- 2) `stdio.h`
- 3) No. Only macro names can be used if the header file is not included.
- 4) Header file.

### Chapter 7

- 1) A group of statements enclosed by curly braces `{}`.

- 2) Comments, preprocessor commands, functions, declarations, variables, statements. (This is a matter of opinion, of course.)
- 3) Not necessarily. It starts wherever main() is.
- 4) It signifies the end of a block, the return of control to something else.■
- 5) The semi-colon (;)

## Chapter 8

- 1) The compiler thinks the rest of the program is all one comment!

## Chapter 9

- 1) function (a,b)

```
int a,b;

{
return (a*b);
}
```

- 2) No.
- 3) The value is discarded.
- 4) The result is garbage.
- 5) By using "return".

## Chapter 10

- 1) A name for some variable, function or macro
- 2) a,c,f
- 3) int i,j;
- 4) double is twice the length of float and can hold significantly larger values.■
- 5) int can have values + or -. Unsigned can only be + and can hold slightly larger + values than int.
- 6) I = 67;
- 7) int
- 8) At the function definition and in the calling function.
- 9) printf ("%d", (int)23.1256);

10) No.

#### Chapter 11

1) With variable parameters or with return()

2) Where a function is defined, after its name: e.g.

```
function (...)  
  
  <-- here  
  
  {  
  }
```

3) Yes.

4) No and it is illegal.

5) \* means "the contents of" and & means "the address of"

6) No.

#### Chapter 12

1) A global variable can be accessed by any part of a program.

2) A local variable can only be accessed by a select part of a program.

3) Local variables cannot leak out. Nothing outside them can reach local variables. ■

4) Variable parameters do. Value parameters use their own local copies, so they do not. ■

5) int i,j;

```
main ()
```

```
{ float x,y;
```

```
  another(x,y);
```

```
}
```

```
  another(x,y)
```

```
float x,y;
```

```
{
```

```
}
```

There are 6 storage spaces altogether.

#### Chapter 13

- 1) #define birthday 19
- 2) #include <math.h>
- 3) false
- 4) false

## Chapter 14

- 1) A variable which holds the address of another variable
- 2) With a \* character. e.g. int \*i;
- 3) Any type at all!
- 4) doubleptr = (double \*)chptr;
- 5) Because number has not been initialized. This expression initializes the place that number points to, not number itself. (See main text)

## Chapter 15

## printf

- 1) #include <stdio.h>  

```
main ()  
  
{  
    printf ("%2e",6.23);  
}
```
- 2) This depends on individual compilers
- 3) a) No conversion string  
b) Conversion string without matching value  
c) Probably nothing  
d) Conversion string without matching value

## scanf

- 1) space, newline or tab
- 5) true.

## Low level I/O

- 1) The statement is possible provided putchar() is not implemented as a macro. It copies the input to the output: a simple way of writing on the screen. (Note however that the output is buffered so characters may not



be seen on the output for some time!)

```
2) ch = getchar();
   putchar (ch);
```

#### Chapter 16

1) The thing(s) an operator acts upon.

```
2) printf ("%d", 5 % 2);
```

```
3) rem = 5 % 2;
```

```
4) variable = 10 - -5;
```

```
5) if (1 != 23)
   {
   printf ("Thank goodness for mathematics");
   }
```

#### Chapter 18

1) Three: while, do..while, for

```
2) while : at the start of each loop
   do    : at the end of each loop
   for   : at the start of each loop
```

3) do..while

```
4) #include <stdio.h>
   #define TRUE 1
```

```
   main ()
```

```
   { char ch;
```

```
   while (true)
```

```
   {
   ch = getchar();
   putchar (ch);
   }
```

#### Chapter 19

1) The array identifier (without square brackets) is a pointer to the first element in the array.

2) You pass the array identifier, without square brackets.  
No! Arrays are always variable parameters.

- 3) `double array[4][5];`  
Valid array bounds from `array[0][0]` to `array[3][4]`

## Chapter 20

- 1) Arrays of characters. Pointers to arrays of characters.
- 2) `static char *strings[];`  
Could then initialize with braces `{}` and item list. (See main text)
- 3) See the Morse code example.

## Chapter 22

- 1) `double`
- 2) Probably true. This is implementation dependent. The actual types are `double`, `long float` and `int`.
- 3) The length of a string (excluding `NULL` byte)
- 4) Joins two strings.
- 5) Overflow, underflow, domain error, Loss of accuracy and division by zero. ■

## Chapter 23

- 1) `++`, `--` and any assignment or unary operator
- 2) It could make a program too difficult to read
- 3) No. The function would return before the value could be incremented.

## Chapter 23

- 1) `FILE` is defined by `stdio.h` It is reserved only when this file is included. It is not a built in part of the language.
- 2) `FILE *fp;`
- 3) False. They are meant for comparative purposes only. It does not make sense to do arithmetic with enumerated data.
- 4) Yes. It provides a generic pointer. i.e. one which can be assigned to any other pointer type.
- 5) `volatile`
- 6) `typedef double real;`
- 7) True.

## Chapter 24

- 1) Nothing -- only the way it is used. Yes, every variable is a bit pattern. It is normal to use integer or character types for bit patterns.
- 2) Inclusive OR is true if all possibilities are true simultaneously. Exclusive OR is false if all possibilities are true simultaneously.
- 3) Some kind of flag message perhaps. A bit pattern for certain.
- 4) a)  $00000111 \& 00000010 == 00000010 == 2$   
 b)  $00000001 \& 00000001 == 00000001 == 1$   
 c)  $00001111 \& 00000011 == 00000011 == 3$   
 d)  $00001111 \& 00000111 == 00000111 == 7$   
 e)  $00001111 \& 00000111 \& 00000011 == 00000011 = 3$
- 5) a)  $00000001 | 00000010 == 00000011 == 3$   
 b)  $00000001 | 00000010 | 00000011 == 00000011 == 3$
- 6) a)  $1 \& (\sim 1) == 00000001 \& 11111110 == 0$   
 b)  $23 \& \sim 23 == 00011111 \& 11100000 == 0$   
 c) similarly 0:  $n \& (\text{NOT } n)$  is always zero

## Chapter 26

- 1) a) a string which labels a file  
 b) a variable of type `*fp` which points to a FILE structure  
 c) the number of a file "portal" in the I/O array
- 2) High level filing performs translations to text. Low level files untrans-  
 lated bit data.
- 3) `fp = fopen ("filename","r");`
- 4) `fd = open ("filename",O_WRONLY);`
- 6) `fprintf ()`

## Chapter 27

- 1) A structure can hold several values at the same time. A union holds only one value at any one time.
- 2) A part of a structure, or a possible occupant of a union.
- 3) `x.mem`
- 4) `ptr->mem`
- 5) False.

## Chapter 28

- 1) A diagram which shows how structures are put together.
- 2) With pointers.
- 3) False. Pointers are used to reference variables and data structures are built in such a way as to require only one name for a whole structure.
- 4) With pointers. `ptr->member` etc...
- 5) `ptr=(struct Binary Tree *)malloc(sizeof(struct Binary Tree));`

## Chapter 29

- 1) A function which is defined in terms of itself.
- 2) A data structure run by the C-language for keeping track of function calls and for storing local data.
- 3) A lot of memory is used as stack space.

## Chapter 31

- 1) Declarations are in the wrong place.
- 2) Missing closing brace }
- 3) Missing semi-colon after closing brace };

# Index

## &

'&' operator ..... 85

## A

a.out ..... 8  
 Address of variables ..... 85  
 Array pointer ..... 93  
 Arrays ..... 171  
 ASCII codes ..... 415  
 Assignment, hidden ..... 233

## B

Binary tree ..... 331  
 Bit operations ..... 255  
 Black boxes ..... 31  
 Braces ..... 26

## C

C library ..... 15  
 Calling functions ..... 32  
 case statement ..... 149  
 Case, upper and lower ..... 9  
 cast operator ..... 47  
 Casting pointers ..... 90  
 char ..... 39  
 Character classification ..... 213  
 Character constants ..... 43  
 Character conversion table ..... 415  
 Comments ..... 29  
 Compiler ..... 5  
 Compiler phases ..... 8  
 Compiling a program ..... 16  
 Conditional compilation ..... 81  
 const, constants ..... 252  
 Constant expressions ..... 243  
 Constants and macros ..... 78  
 Control characters ..... 43  
 Control characters, printf ..... 102  
 Conversion characters, scanf ..... 105  
 Conversion table ..... 415  
 Curly braces ..... 26

## D

Data structures ..... 325

Debugging ..... 387  
 Decisions ..... 135  
 Declarations ..... 10  
 Devices ..... 15  
 do while ..... 160

## E

End of file ..... 277  
 enum type ..... 244  
 Enumerated data ..... 244  
 Environment variables ..... 210  
 Environment variables in C ..... 211  
 Eratosthenes sieve ..... 175  
 Errors, diagnosing ..... 387  
 Errors, files ..... 283  
 Errors, of purpose ..... 9  
 Errors, programming ..... 8  
 Escaping from an program ..... 17  
 Example code ..... 347  
 exit function ..... 37  
 Expressions ..... 36  
 Extern class ..... 49

## F

FILE ..... 244  
 File descriptors ..... 288  
 File extensions ..... 16  
 File handles ..... 288  
 File, detecting end of ..... 277  
 File, opening ..... 271  
 Files ..... 267  
 Files and devices ..... 15  
 Files as abstractions ..... 97  
 Format specifiers, printf ..... 102  
 Formatting text and variables ..... 11  
 Function names ..... 32  
 Functions ..... 31  
 Functions with values ..... 35

## G

Game of life ..... 181  
 gcc ..... 8  
 getchar ..... 117  
**getenv() function** ..... 211  
 gets ..... 119, 205  
 Global variables ..... 69

Global variables and recursion . . . . . 345  
 GNU compiler . . . . . 8

## H

Header files . . . . . 19  
 Hidden assignment . . . . . 233  
 High level . . . . . 1

## I

Identifier names . . . . . 32  
 if . . . . . 135  
 if statement . . . . . 136  
 Initialization of arrays . . . . . 189  
 Initializing structures . . . . . 318  
 Initializing variables . . . . . 42  
 int . . . . . 39, 44  
 Integer types . . . . . 39  
 Integers . . . . . 44  
 Interrupting a program . . . . . 17

## K

Keyboard input . . . . . 98

## L

Layout . . . . . 23  
 Levels of detail . . . . . 1  
 Libraries . . . . . 11  
 Libraries of functions . . . . . 19  
 Linked list . . . . . 331  
 Linker . . . . . 8  
 Local environment . . . . . 5  
 Local variables . . . . . 41, 69  
 Logical errors . . . . . 9  
 long . . . . . 39, 44  
 Loop variables . . . . . 46  
 Loops . . . . . 155  
 Low level . . . . . 1

## M

Machine level operations . . . . . 255  
 Macros . . . . . 78  
 main function . . . . . 26  
 Mainframe . . . . . 15  
 malloc . . . . . 319  
 Math errors . . . . . 226  
 Mathematical functions . . . . . 222

Memory allocation, dynamical . . . . . 319  
 Multidimensional arrays . . . . . 178

## N

Names, for identifiers . . . . . 32  
 Nested ifs . . . . . 143  
 Non-printable characters . . . . . 43

## O

Opening a file . . . . . 271  
 Operating system . . . . . 15  
 Operators . . . . . 121  
 Operators, hidden . . . . . 231  
 Output, formatting . . . . . 11

## P

Panic button . . . . . 17  
 Parameters to functions . . . . . 53  
 Parsing strings . . . . . 207  
 Phases of compilation . . . . . 8  
 Poem . . . . . 12  
 Pointers . . . . . 85  
 Pointers to functions . . . . . 92  
 Preprocessor . . . . . 77  
 Prime number generator . . . . . 175  
 printf function . . . . . 11, 98  
 Printing . . . . . 11  
 Printing formatted to strings . . . . . 206  
 Prototyping . . . . . 59  
 putchar . . . . . 117, 119  
 puts . . . . . 119, 206

## R

Records . . . . . 303  
 Records (structures) . . . . . 253  
 Recursion . . . . . 335  
 Recursion and global variables . . . . . 345  
 Reserved words . . . . . 11  
 Returning values . . . . . 36

## S

scanf . . . . . 105  
 scanf, dangers . . . . . 108  
 Scope . . . . . 41, 69  
 Screen editor . . . . . 5  
 Screen output . . . . . 98

Shell ..... 5, 15  
 short ..... 39, 44  
 Snakes and ladders ..... 35  
 Special characters ..... 43, 104  
 Stack ..... 335  
 Standard error ..... 15  
 Standard input ..... 15  
 Standard input/output ..... 97  
 Standard output ..... 15  
 Static initialization of arrays ..... 189  
 Static variables ..... 50  
 stderr ..... 97  
 stdin ..... 97  
 stdio.h ..... 19  
 stdout ..... 97  
 strcmp ..... 202  
 strcpy ..... 202  
 Streams ..... 97, 106  
 String handling functions ..... 202  
 Strings ..... 193  
 strlen ..... 202  
 strstr ..... 203  
 Structure ..... 253  
 Structure of a C program ..... 25  
 Structured data ..... 303  
 Structures ..... 303  
 Structures, initializing ..... 318  
 Style ..... 23, 139, 238  
 Style, global variables ..... 73  
 Substrings, searching for ..... 203  
 switch case ..... 149  
 Syntax error ..... 8

**T**

Tables ..... 171  
 Terminating a program ..... 37  
 Tests ..... 135  
 Type conversion ..... 47  
 Types ..... 47  
 Types, advanced ..... 243

**U**

Union ..... 320  
 Unions ..... 253, 303

**V**

Value parameters ..... 54  
 Variable names ..... 39  
 Variable types ..... 47  
 Variables ..... 10, 39  
 Variables, declaring ..... 40  
 Variables, initializing ..... 42  
 void ..... 250  
 volatile ..... 251

**W**

Whiet space ..... 29  
 while loop ..... 155  
 White space ..... 69





# Table of Contents

<b>Preface</b> .....	<b>xi</b>
<b>1 Introduction</b> .....	<b>1</b>
1.1 High Levels and Low Levels .....	1
1.2 Basic ideas about C .....	5
1.3 The Compiler .....	5
1.4 Errors .....	8
1.5 Use of Upper and Lower Case .....	9
1.6 Declarations .....	10
1.7 Questions .....	10
<b>2 Reserved words and an example</b> .....	<b>11</b>
2.1 The <code>printf()</code> function .....	11
2.2 Example Listing .....	12
2.3 Output .....	12
2.4 Questions .....	12
<b>3 Operating systems and environments</b> .....	<b>13</b>
3.1 Files and Devices .....	13
3.2 Filenames .....	14
3.3 Command Languages and Consoles .....	14
3.4 Questions .....	15
<b>4 Libraries</b> .....	<b>17</b>
4.1 Questions .....	19
<b>5 Programming style</b> .....	<b>21</b>
<b>6 The form of a C program</b> .....	<b>23</b>
6.1 Questions .....	26
<b>7 Comments</b> .....	<b>27</b>
7.1 Example 1 .....	27
7.2 Example 2 .....	27
7.3 Question .....	28

<b>8</b>	<b>Functions</b> .....	<b>29</b>
8.1	Structure diagram .....	31
8.2	Program Listing .....	31
8.3	Functions with values .....	32
8.4	Breaking out early .....	34
8.5	The <code>exit()</code> function .....	34
8.6	Functions and Types .....	35
8.7	Questions .....	35
<b>9</b>	<b>Variables, Types and Declarations</b> .....	<b>37</b>
9.1	Declarations .....	38
9.2	Where to declare things .....	38
9.3	Declarations and Initialization .....	39
9.4	Individual Types .....	40
9.4.1	<code>char</code> .....	40
9.4.2	Listing .....	41
9.4.3	Integers .....	42
9.5	Whole numbers .....	42
9.5.1	Floating Point .....	42
9.6	Choosing Variables .....	43
9.7	Assigning variables to one another .....	44
9.8	Types and The Cast Operator .....	44
9.9	Storage class <code>static</code> and <code>extern</code> .....	47
9.10	Functions, Types and Declarations .....	48
9.11	Questions .....	49
<b>10</b>	<b>Parameters and Functions</b> .....	<b>51</b>
10.1	Declaring Parameters .....	51
10.2	Value Parameters .....	52
10.3	Functions as actual parameters .....	57
10.4	Example Listing .....	57
10.5	Example Listing .....	58
10.6	Variable Parameters .....	60
10.7	Example Listing .....	63
10.8	Questions .....	63
<b>11</b>	<b>Scope : Local And Global</b> .....	<b>65</b>
11.1	Global Variables .....	65
11.2	Local Variables .....	65
11.3	Communication : parameters .....	68
11.4	Example Listing .....	68
11.5	Style Note .....	69
11.6	Scope and Style .....	70
11.7	Questions .....	70

<b>12</b>	<b>Preprocessor Commands</b> .....	<b>71</b>
12.1	Macro Functions .....	72
12.2	When and when not to use macros with parameters .....	73
12.3	Example Listing .....	73
12.4	Note about <code>#include</code> .....	74
12.5	Other Preprocessor commands .....	74
12.6	Example .....	75
12.7	Questions .....	76
<b>13</b>	<b>Pointers</b> .....	<b>77</b>
13.1	'&' and '*' .....	78
13.2	Uses for Pointers .....	79
13.3	Pointers and Initialization .....	80
13.4	Example Listing .....	81
13.5	Types, Casts and Pointers .....	83
13.6	Pointers to functions .....	84
13.7	Calling a function by pointer .....	85
13.8	Questions .....	86
<b>14</b>	<b>Standard Output and Standard Input</b> .....	<b>89</b>
14.1	<code>printf</code> .....	90
14.2	Example Listing .....	92
14.3	Output .....	92
14.4	Formatting with <code>printf</code> .....	93
14.5	Example Listing .....	94
14.6	Output .....	95
14.7	Special Control Characters .....	95
14.8	Questions .....	96
14.9	<code>scanf</code> .....	96
14.10	Conversion characters .....	97
14.11	How does <code>scanf</code> see the input? .....	97
14.12	First account of <code>scanf</code> .....	98
14.13	The dangerous function .....	98
14.14	Keeping <code>scanf</code> under control .....	99
14.15	Examples .....	100
14.16	Matching without assigning .....	105
14.17	Formal Definition of <code>scanf</code> .....	106
14.18	Summary of points about <code>scanf</code> .....	107
14.19	Questions .....	107
14.20	Low Level Input/Output .....	108
14.20.1	<code>getchar</code> and <code>putchar</code> .....	108
14.20.2	<code>gets</code> and <code>puts</code> .....	109
14.21	Questions .....	110

<b>15</b>	<b>Assignments, Expressions and Operators</b>	<b>111</b>
15.1	Expressions and values	111
15.2	Example	113
15.3	Output	113
15.4	Parentheses and Priority	114
15.5	Unary Operator Precedence	115
15.6	Special Assignment Operators ++ and --	115
15.7	More Special Assignments	116
15.8	Example Listing	117
15.9	Output	118
15.10	The Cast Operator	118
15.11	Expressions and Types	118
15.12	Comparisons and Logic	119
15.13	Summary of Operators and Precedence	121
15.14	Questions	122
<b>16</b>	<b>Decisions</b>	<b>123</b>
16.1	if	124
16.2	Example Listings	127
16.3	if ... else	129
16.4	Nested ifs and logic	130
16.5	Example Listing	132
16.6	Stringing together if..else	133
16.7	switch: integers and characters	135
16.8	Example Listing	137
16.9	Things to try	139
<b>17</b>	<b>Loops</b>	<b>141</b>
17.1	while	141
17.2	Example Listing	143
17.3	Example Listing	145
17.4	do..while	146
17.5	Example Listing	147
17.6	for	149
17.7	Example Listing	150
17.8	The flexible for loop	151
17.9	Quitting Loops and Hurrying Them Up!	153
17.10	Nested Loops	154
17.11	Questions	155

<b>18</b>	<b>Arrays</b> .....	<b>157</b>
18.1	Why use arrays? .....	157
18.2	Limits and The Dimension of an array .....	159
18.3	Arrays and for loops .....	160
18.4	Example Listing .....	161
18.5	Arrays Of More Than One Dimension .....	163
18.6	Arrays and Nested Loops .....	165
18.7	Example Listing .....	165
18.8	Output of Game of Life .....	170
18.9	Initializing Arrays .....	173
18.10	Arrays and Pointers .....	174
18.11	Arrays as Parameters .....	175
18.12	Questions .....	175
<b>19</b>	<b>Strings</b> .....	<b>177</b>
19.1	Conventions and Declarations .....	177
19.2	Strings, Arrays and Pointers .....	177
19.3	Arrays of Strings .....	180
19.4	Example Listing .....	181
19.5	Strings from the user .....	182
19.6	Handling strings .....	185
19.7	Example Listing .....	186
19.8	String Input/Output .....	188
19.8.1	gets() .....	188
19.8.2	puts() .....	189
19.8.3	sprintf() .....	189
19.8.4	sscanf() .....	189
19.9	Example Listing .....	190
19.10	Questions .....	190
<b>20</b>	<b>Putting together a program</b> .....	<b>193</b>
20.1	The argument vector .....	193
20.2	Processing options .....	194
20.3	Environment variables .....	194

<b>21</b>	<b>Special Library Functions and Macros ...</b>	<b>197</b>
21.1	Character Identification .....	197
21.2	Examples .....	198
21.3	Program Output .....	200
21.4	String Manipulation .....	201
21.5	Examples .....	204
21.6	Mathematical Functions .....	204
21.7	Examples .....	207
21.8	Maths Errors .....	209
21.9	Example .....	210
21.10	Questions .....	211
<b>22</b>	<b>Hidden operators and values .....</b>	<b>213</b>
22.1	Extended and Hidden = .....	214
22.2	Example .....	215
22.3	Hidden ++ and -- .....	216
22.4	Arrays, Strings and Hidden Operators .....	217
22.5	Example .....	218
22.6	Cautions about Style .....	219
22.7	Example .....	220
22.8	Questions .....	221
<b>23</b>	<b>More on data types .....</b>	<b>223</b>
23.1	Special Constant Expressions .....	223
23.2	FILE .....	224
23.3	enum .....	224
23.4	Example .....	225
23.5	Example .....	227
23.6	Suggested uses for enum .....	228
23.7	void .....	229
23.8	volatile .....	230
23.9	const .....	231
23.10	struct .....	232
23.11	union .....	232
23.12	typedef .....	232
23.13	Questions .....	233

<b>24</b>	<b>Machine Level Operations</b>	<b>235</b>
24.1	Bit Patterns	235
24.2	Flags, Registers and Messages	236
24.3	Bit Operators and Assignments	236
24.4	The Meaning of Bit Operators	237
24.5	Shift Operations	237
24.6	Truth Tables and Masking	239
24.6.1	Complement $\sim$	239
24.6.2	AND $\&$	239
24.6.3	OR $ $	239
24.6.4	XOR/EOR $\wedge$	240
24.7	Example	241
24.8	Output	241
24.9	Example	242
24.10	Example	243
24.11	Questions	243
<b>25</b>	<b>Files and Devices</b>	<b>245</b>
25.1	Files Generally	245
25.2	File Positions	247
25.3	High Level File Handling Functions	247
25.4	Opening files	248
25.5	Closing a file	249
25.6	<code>fprintf()</code>	250
25.7	<code>fscanf()</code>	250
25.8	<code>skipfilegarb()</code> ?	251
25.9	Single Character I/O	251
25.10	<code>getc()</code> and <code>fgetc()</code>	252
25.11	<code>ungetc()</code>	252
25.12	<code>putc()</code> and <code>fputc()</code>	253
25.13	<code>fgets()</code> and <code>fputs()</code>	253
25.14	<code>feof()</code>	254
25.15	Printer Output	254
25.16	Example	255
25.17	Output	258
25.18	Converting the example	259
25.19	Filing Errors	259
25.20	Other Facilities for High Level Files	260
25.21	<code>fread()</code> and <code>fwrite()</code>	260
25.22	File Positions: <code>ftell()</code> and <code>fseek()</code>	261
25.23	<code>rewind()</code>	262
25.24	<code>fflush()</code>	263
25.25	Low Level Filing Operations	263
25.26	File descriptors	264
25.27	<code>open()</code>	264

25.28	<code>close()</code> .....	265
25.29	<code>creat()</code> .....	265
25.30	<code>read()</code> .....	266
25.31	<code>write()</code> .....	266
25.32	<code>lseek()</code> .....	267
25.33	<code>unlink()</code> and <code>remove()</code> .....	267
25.34	Example .....	268
25.35	Questions .....	274
<b>26</b>	<b>Structures and Unions .....</b>	<b>277</b>
26.1	Organization: Black Box Data .....	277
26.2	<code>struct</code> .....	278
26.3	Declarations .....	279
26.4	Scope .....	281
26.5	Using Structures .....	281
26.6	Arrays of Structures .....	283
26.7	Example .....	283
26.8	Structures of Structures .....	286
26.9	Pointers to Structures .....	287
26.10	Example .....	288
26.11	Pre-initializing Static Structures .....	290
26.12	Creating Memory for Dynamical struct Types .....	291
26.13	Unions .....	292
26.13.1	Declaration .....	293
26.13.2	Using unions .....	293
26.14	Questions .....	294
<b>27</b>	<b>Data Structures .....</b>	<b>297</b>
27.1	Data Structure Diagrams .....	298
27.2	The Tools: Structures, Pointers and Dynamic Memory .....	300
27.3	Programme For Building Data Structures .....	301
27.4	Setting Up A Data Structure .....	301
27.5	Example Structures .....	303
27.6	Questions .....	304
<b>28</b>	<b>Recursion .....</b>	<b>307</b>
28.1	Functions and The Stack .....	307
28.2	Levels and Wells .....	311
28.3	Tame Recursion and Self-Similarity .....	312
28.4	Simple Example without a Data Structure .....	312
28.5	Simple Example With a Data Structure .....	314
28.6	Advantages and Disadvantages of Recursion .....	316
28.7	Recursion and Global Variables .....	316
28.8	Questions .....	317



<b>29</b>	<b>Example Programs</b> .....	<b>319</b>
29.1	Statistical Data Handler .....	319
29.1.1	The Editor .....	319
29.1.2	Insert/Overwrite .....	319
29.1.3	Quitting Sections .....	319
29.1.4	The Program Listing .....	320
29.2	Listing .....	322
29.3	Variable Cross Referencer .....	336
29.3.1	Listing Cref.c .....	337
29.3.2	Output of Cross Referencer .....	348
29.3.3	Comments .....	352
<b>30</b>	<b>Errors and debugging</b> .....	<b>353</b>
30.1	Compiler Trappable Errors .....	353
30.1.1	Missing semicolon; .....	353
30.1.2	Missing closing brace } .....	353
30.1.3	Mistyping Upper/Lower Case .....	353
30.1.4	Missing quote " .....	354
30.1.5	Variable not declared or scope wrong .....	354
30.1.6	Using a function or assignment inside a macro .....	354
30.1.7	Forgetting to declare a function which is not type int ...	354
30.1.8	Type mismatch in expressions .....	355
30.2	Errors not trappable by a compiler (run time errors) .....	355
30.2.1	Confusion of = and == .....	355
30.2.2	Missing & in scanf .....	356
30.2.3	Confusing C++ and ++C .....	356
30.2.4	Unwarranted assumptions about storage .....	356
30.2.5	The number of actual and formal parameters does not match .....	357
30.2.6	The conversion string in scanf/printf is wrong .....	357
30.2.7	Accidental confusion of int, short and char .....	359
30.2.8	Arrays out of bounds .....	359
30.2.9	Mathematical Error .....	359
30.2.10	Uncoordinated Output using buffered I/O .....	359
30.2.11	Global Variables and Recursion .....	360
30.3	Tracing Errors .....	360
30.3.1	Locating a problem .....	360
30.4	Pathological Problems .....	361
30.5	Porting Programs between computers .....	361
30.6	Questions .....	362

<b>31</b>	<b>Summary of C</b> .....	<b>365</b>
31.1	Reserved Words .....	365
31.2	Preprocessor Directives .....	366
31.3	Header Files and Libraries .....	366
31.4	Constants .....	366
31.5	Primitive Data Types .....	367
31.6	Storage Classes .....	367
31.7	Identifiers .....	367
31.8	Statements .....	368
31.9	Character Utilities .....	369
31.10	Special Control Characters .....	370
31.11	Input/Output Functions .....	371
31.12	<code>printf</code> conversion specifiers .....	372
31.13	<code>scanf</code> conversion specifiers .....	372
31.14	Maths Library .....	373
31.15	<code>goto</code> .....	373
<b>Appendix A</b>	<b>All the Reserved Words</b> .....	<b>375</b>
<b>Appendix B</b>	<b>Three Languages: Words and Symbols Compared</b> .....	<b>377</b>
<b>Appendix C</b>	<b>Character Conversion Table</b> ...	<b>379</b>
<b>Appendix D</b>	<b>Emacs style file</b> .....	<b>381</b>
<b>Appendix E</b>	<b>Answers to questions</b> .....	<b>385</b>
<b>Index</b> .....		<b>393</b>